



RoHS compliant

### FEATURES

#### 1. High frequency characteristics (Impedance 50Ω, ~1.0GHz)

- Insertion loss; Max. 0.3dB
- Isolation; Min. 20dB (Between open contacts)  
Min. 30dB (Between contact sets)
- V.S.W.R.; Max. 1.2

#### 2. Surface mount terminal

This relay is a surface-mounted model with excellent high-frequency properties. In addition, it can use a microstrip line in the base circuit design which spares the labor of machining the base.

#### 3. Low profile small type

9.7(W)×14.7(L)×5.9(H) mm  
.382(W)×.579(L)×.232(H) inch

**4. High sensitivity: 140 mW nominal operating power (Single side stable, 2 coil latching)**

**5. High contact reliability**  
**Electrical life: Min. 10<sup>7</sup> (10mA 10V DC)**

### TYPICAL APPLICATIONS

- **Measurement instruments**  
Oscilloscope attenuator circuit
- **All types of communication device**

If you wish to use in applications with low level loads or with high frequency switching, please consult us.

### ORDERING INFORMATION

|   |     |   |  |   |   |  |  |  |
|---|-----|---|--|---|---|--|--|--|
|   | ARA | 2 |  | 0 | A |  |  |  |
| RA relays   |     |   |  |   |   |  |  |  |
| Contact arrangement<br>2: 2 Form C  |     |   |  |   |   |  |  |  |
| Operating function<br>0: Single side stable<br>1: 1 coil latching<br>2: 2 coil latching   |     |   |  |   |   |  |  |  |
| Type of operation<br>0: Standard type (B.B.M)   |     |   |  |   |   |  |  |  |
| Terminal shape<br>A: Surface-mount terminal   |     |   |  |   |   |  |  |  |
| Coil voltage, V DC<br>1H: 1.5, 03: 3, 4H: 4.5, 05: 5, 06: 6, 09: 9, 12: 12, 24: 24, 48: 48<br>(H=0.5)   |     |   |  |   |   |  |  |  |
| Packing style<br>Nil: Tube packing<br>X: Tape and reel packing (picked from 1 pin side)<br>Z: Tape and reel packing (picked from 10 pin side) |     |   |  |   |   |  |  |  |

### TYPES

#### 1. Tube packing

| Contact arrangement | Nominal coil voltage | Part No.           |                 |                 |
|---------------------|----------------------|--------------------|-----------------|-----------------|
|                     |                      | Single side stable | 1 coil latching | 2 coil latching |
| 2 Form C            | 1.5V DC              | ARA200A1H          | ARA210A1H       | ARA220A1H       |
|                     | 3 V DC               | ARA200A03          | ARA210A03       | ARA220A03       |
|                     | 4.5V DC              | ARA200A4H          | ARA210A4H       | ARA220A4H       |
|                     | 5 V DC               | ARA200A05          | ARA210A05       | ARA220A05       |
|                     | 6 V DC               | ARA200A06          | ARA210A06       | ARA220A06       |
|                     | 9 V DC               | ARA200A09          | ARA210A09       | ARA220A09       |
|                     | 12 V DC              | ARA200A12          | ARA210A12       | ARA220A12       |
|                     | 24 V DC              | ARA200A24          | ARA210A24       | ARA220A24       |
| 48 V DC             | ARA200A48            | —                  | —               |                 |

Standard packing: 40 pcs. in an inner package (tube); 1,000 pcs. in an outer package

# RA (ARA)

## 2. Tape and reel packing

| Contact arrangement | Nominal coil voltage | Part No.           |                 |                 |
|---------------------|----------------------|--------------------|-----------------|-----------------|
|                     |                      | Single side stable | 1 coil latching | 2 coil latching |
| 2 Form C            | 1.5V DC              | ARA200A1HZ         | ARA210A1HZ      | ARA220A1HZ      |
|                     | 3 V DC               | ARA200A03Z         | ARA210A03Z      | ARA220A03Z      |
|                     | 4.5V DC              | ARA200A4HZ         | ARA210A4HZ      | ARA220A4HZ      |
|                     | 5 V DC               | ARA200A05Z         | ARA210A05Z      | ARA220A05Z      |
|                     | 6 V DC               | ARA200A06Z         | ARA210A06Z      | ARA220A06Z      |
|                     | 9 V DC               | ARA200A09Z         | ARA210A09Z      | ARA220A09Z      |
|                     | 12 V DC              | ARA200A12Z         | ARA210A12Z      | ARA220A12Z      |
|                     | 24 V DC              | ARA200A24Z         | ARA210A24Z      | ARA220A24Z      |
|                     | 48 V DC              | ARA200A48Z         | —               | —               |

Standard packing: 500 pcs. in an inner package (tape and reele); 1,000 pcs. in an outer package

Note: Tape and reel packing symbol "-Z" is not marked on the relay. "X" type tape and reel packing (picked from 1-pin side) is also available.

## RATING

### 1. Coil data

#### 1) Single side stable

| Nominal coil voltage | Pick-up voltage (at 20°C 68°F)             | Drop-out voltage (at 20°C 68°F)            | Nominal operating current [±10%] (at 20°C 68°F) | Coil resistance [±10%] (at 20°C 68°F) | Nominal operating power | Max. applied voltage (at 20°C 68°F) |
|----------------------|--|--|---|---------------------------------------|-------------------------|-------------------------------------|
| 1.5V DC              | 75%V or less of nominal voltage* (Initial) | 10%V or more of nominal voltage* (Initial) | 93.8mA  | 16 Ω                                  | 140mW                   | 150%V of nominal voltage            |
| 3 V DC               |  |  | 46.7mA  | 64.3Ω                                 |                         |                                     |
| 4.5V DC              |  |  | 31 mA   | 145 Ω                                 |                         |                                     |
| 5 V DC               |  |  | 28.1mA  | 178 Ω                                 |                         |                                     |
| 6 V DC               |  |  | 23.3mA  | 257 Ω                                 |                         |                                     |
| 9 V DC               |  |  | 15.5mA  | 579 Ω                                 |                         |                                     |
| 12 V DC              |  |  | 11.7mA  | 1,028 Ω                               | 200mW                   |                                     |
| 24 V DC              |  |  | 8.3mA   | 2,880 Ω                               |                         |                                     |
| 48 V DC              |  |  | 6.3mA   | 7,680 Ω                               | 300mW                   | 120%V of nominal voltage            |

#### 2) 1 coil latching

| Nominal coil voltage | Set voltage (at 20°C 68°F)                 | Reset voltage (at 20°C 68°F)               | Nominal operating current [±10%] (at 20°C 68°F) | Coil resistance [±10%] (at 20°C 68°F) | Nominal operating power | Max. applied voltage (at 20°C 68°F) |
|----------------------|--|--|---|---------------------------------------|-------------------------|-------------------------------------|
| 1.5V DC              | 75%V or less of nominal voltage* (Initial) | 75%V or less of nominal voltage* (Initial) | 46.9mA  | 32 Ω                                  | 70mW                    | 150%V of nominal voltage            |
| 3 V DC               |  |  | 23.3mA  | 128.6Ω                                |                         |                                     |
| 4.5V DC              |  |  | 15.6mA  | 289.3Ω                                |                         |                                     |
| 5 V DC               |  |  | 14 mA   | 357 Ω                                 |                         |                                     |
| 6 V DC               |  |  | 11.7mA  | 514 Ω                                 |                         |                                     |
| 9 V DC               |  |  | 7.8mA   | 1,157 Ω                               |                         |                                     |
| 12 V DC              |  |  | 5.8mA   | 2,057 Ω                               | 100mW                   |                                     |
| 24 V DC              |  |  | 4.2mA   | 5,760 Ω                               |                         |                                     |

#### 3) 2 coil latching

| Nominal coil voltage | Set voltage (at 20°C 68°F)                 | Reset voltage (at 20°C 68°F)               | Nominal operating current [±10%] (at 20°C 68°F) | Coil resistance [±10%] (at 20°C 68°F) | Nominal operating power | Max. applied voltage (at 20°C 68°F) |
|----------------------|--|--|---|---------------------------------------|-------------------------|-------------------------------------|
| 1.5V DC              | 75%V or less of nominal voltage* (Initial) | 75%V or less of nominal voltage* (Initial) | 93.8mA  | 16 Ω                                  | 140mW                   | 150%V of nominal voltage            |
| 3 V DC               |  |  | 46.7mA  | 64.3Ω                                 |                         |                                     |
| 4.5V DC              |  |  | 31 mA   | 145 Ω                                 |                         |                                     |
| 5 V DC               |  |  | 28.1mA  | 178 Ω                                 |                         |                                     |
| 6 V DC               |  |  | 23.3mA  | 257 Ω                                 |                         |                                     |
| 9 V DC               |  |  | 15.5mA  | 579 Ω                                 |                         |                                     |
| 12 V DC              |  |  | 11.7mA  | 1,028 Ω                               | 200mW                   |                                     |
| 24 V DC              |  |  | 8.3mA   | 2,880 Ω                               |                         |                                     |

\*Pulse drive (JIS C5442-1996)

2. Specifications

| Characteristics   | Item   | Specifications  |   |
|---|--|---|---|
| Contact   | Arrangement                                      | 2 Form C  |   |
|   | Contact material                                 | Stationary: AgPd + Au clad, Movable: AgPd   |   |
|   | Initial contact resistance, max.                 | Max. 75mΩ (By voltage drop 6V DC 1A)  |   |
| Rating  | Contact rating                                   | 10mA 10V DC (resistive load), 1A 30V DC (resistive load)  |   |
|   | Contact carrying power                           | 3W (at 1GHz, impedance 50Ω, V.S.W.R. max.1.2)   |   |
|   | Max. switching voltage                           | 30V DC  |   |
|   | Max. switching current                           | 1A  |   |
|   | Nominal operating power                          | Single side stable<br>1 coil latching<br>2 coil latching  | 140mW (1.5 to 12V), 200mW (24V), 300mW (48V)<br>70 mW (1.5 to 12V), 100mW (24V)<br>140mW (1.5 to 12V), 200mW (24V)              |
| High frequency characteristics (Initial) (~1GHz, Impedance 50Ω) | Isolation  | Between open contacts   | Min. 20dB   |
|   |  | Between contact sets  | Min. 30dB   |
|   | Insertion loss (without D.U.T. board's loss)     | Max. 0.3dB  |   |
|   | V.S.W.R.   | Max. 1.2  |   |
| Input power   | 3W (at 1GHz, impedance 50Ω, V.S.W.R. max.1.2)    |   |   |
| Electrical characteristics                                      | Insulation resistance (Initial)                  |   | Min. 100MΩ (at 500V DC)<br>Measurement at same location as "Initial breakdown voltage" section.                                 |
|   | Breakdown voltage (Initial)                      | Between open contacts   | 750 Vrms for 1min. (Detection current: 10mA)  |
|   |  | Between contact sets  | 1,000 Vrms for 1min. (Detection current: 10mA)  |
|   |  | Between contact and coil  | 1,000 Vrms for 1min. (Detection current: 10mA)  |
|   |  | Between contact and earth terminal  | 1,000 Vrms for 1min. (Detection current: 10mA)  |
|   | Temperature rise (at 20°C)                       |   | Max. 60°C<br>(By resistive method, nominal voltage applied to the coil, 1GHz, 3W, V.S.W.R. max.1.2)                             |
|   | Operate time [Set time] (at 20°C)                |   | Max. 4ms (Approx. 2ms) [Max. 4ms (Approx. 2ms)] (Nominal operating voltage applied to the coil, excluding contact bounce time.) |
| Release time [Reset time] (at 20°C)                             |  | Max. 4ms (Approx. 1ms) [Max. 4ms (Approx. 2ms)] (Nominal operating voltage applied to the coil, excluding contact bounce time.) (without diode) |   |
| Mechanical characteristics                                      | Shock resistance                                 | Functional  | Min. 500 m/s <sup>2</sup> (Half-wave pulse of sine wave: 11ms; detection time: 10μs.)   |
|   |  | Destructive   | Min. 1,000 m/s <sup>2</sup> (Half-wave pulse of sine wave: 6ms.)  |
|   | Vibration resistance                             | Functional  | 10 to 55 Hz at double amplitude of 3mm (Detection time: 10μs.)  |
|   |  | Destructive   | 10 to 55 Hz at double amplitude of 5mm  |
| Expected life   | Mechanical                                       |   | Min. 10 <sup>8</sup> (at 180 cpm)   |
|   | Electrical                                       |   | Min. 10 <sup>7</sup> (at 20 cpm) (10mA 10V DC resistive load)<br>Min. 10 <sup>5</sup> (at 20 cpm) (1A 30V DC resistive load)    |
| Conditions  | Conditions for operation, transport and storage* |   | Ambient temperature: -40°C to +85°C -40°F to +185°F<br>Humidity: 5 to 85% R.H. (Not freezing and condensing at low temperature) |
| Unit weight   |  |   | Approx. 2 g .07 oz  |

Note: \* The upper operation ambient temperature limit is the maximum temperature that can satisfy the coil temperature rise value. Refer to [6] AMBIENT ENVIRONMENT in GENERAL APPLICATION GUIDELINES.

REFERENCE DATA

1-(1). High frequency characteristics (Impedance 50Ω)

Sample: ARA200A12

Measuring method: Measured with HP network analyzer (HP8753C).

• V.S.W.R.

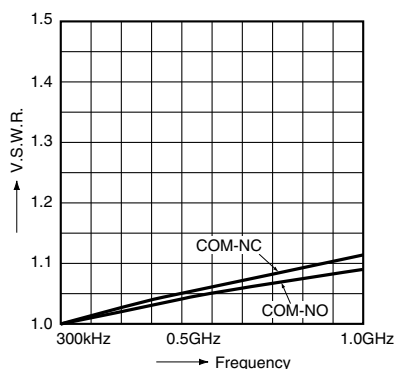

• Insertion loss

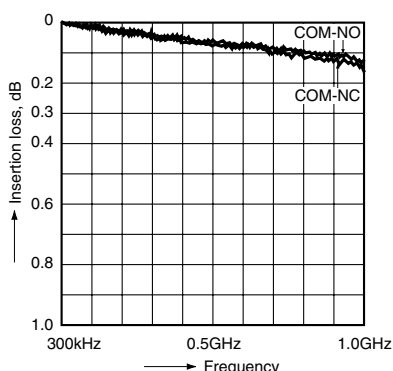

• Isolation

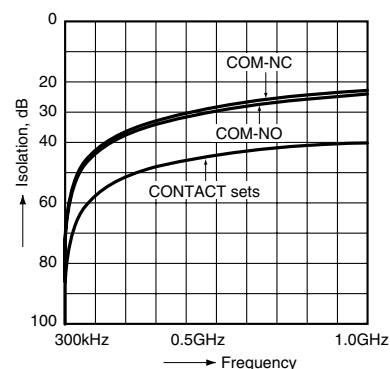

# RA (ARA)

1-(2). High frequency characteristics (Impedance 75Ω)

Sample: ARA200A12

Measuring method: Measured with HP network analyzer (HP8753C).

• V.S.W.R.

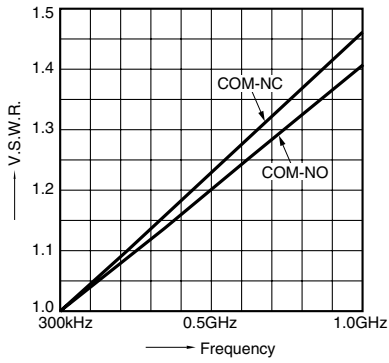

• Insertion loss

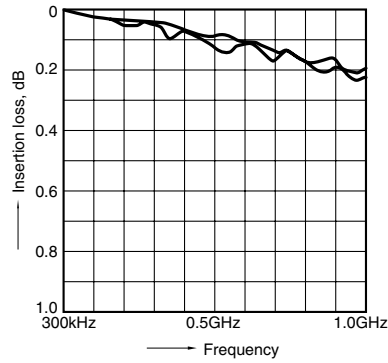

• Isolation

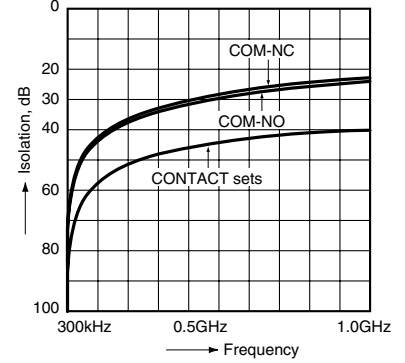

## DIMENSIONS (mm inch)

The CAD data of the products with a **CAD Data** mark can be downloaded from: <http://industrial.panasonic.com/ac/e/>

**CAD Data**

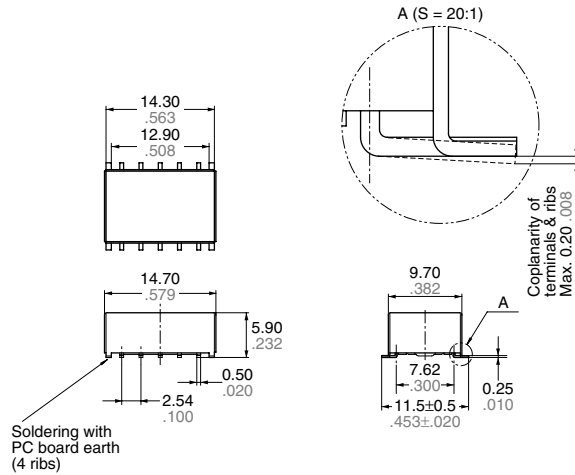

Tolerance:  $\pm 0.3 \pm 0.12$

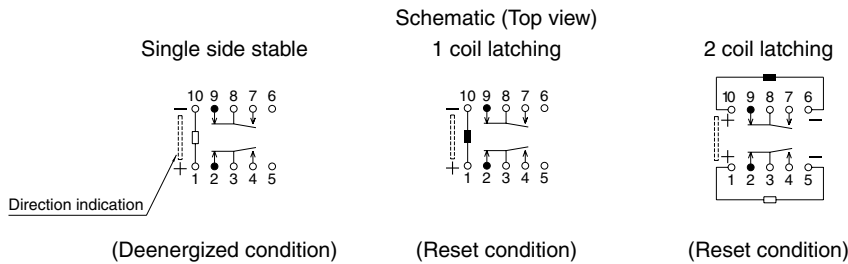

Note: Please consult us regarding recommended PC board patterns.

**NOTES**

**1. Coil operating power**

Pure DC current should be applied to the coil. The wave form should be rectangular. If it includes ripple, the ripple factor should be less than 5%. However, check it with the actual circuit since the characteristics may be slightly different. The nominal operating voltage should be applied to the coil for more than 10 ms to set/reset the latching type relay.

**2. Coil connection**

When connecting coils, refer to the wiring diagram to prevent mis-operation or malfunction.

**3. External magnetic field**

Since RA relays are highly sensitive polarized relays, their characteristics will be affected by a strong external magnetic field. Avoid using the relay under that condition.

**4. Cleaning**

For automatic cleaning, the boiling method is recommended. Avoid ultrasonic cleaning which subjects the relays to high frequency vibrations, which may cause the contacts to stick. It is recommended that alcoholic solvents be used.

**5. Tape and reel packing**

1) Tape dimensions

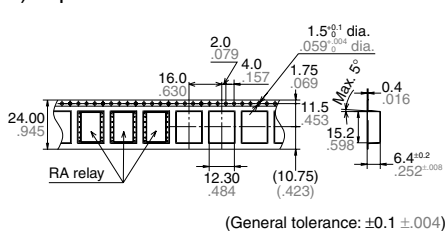

2) X type, Z type

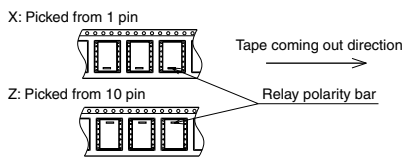

3) Dimensions of plastic reel

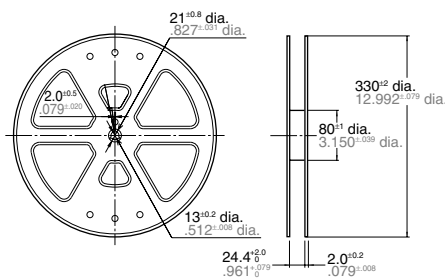

**6. Soldering**

Manual soldering shall be performed under following condition.  
Tip temperature: 280°C to 300°C 536°F to 572°F.

Wattage: 30 to 60W

Soldering time: within 5s

In case of automatic soldering, the following conditions should be observed

1) Position of measuring temperature

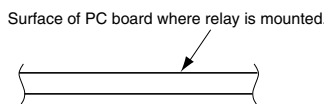

2) IR (infrared reflow) soldering method

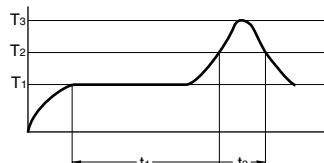

T<sub>1</sub> = 150 to 180°C 302 to 356°F      t<sub>1</sub> = 60 to 120 sec.  
T<sub>2</sub> = 230°C 446°F and higher      t<sub>2</sub> = Within 30 sec.  
T<sub>3</sub> = Within 250°C 482°F

Temperature rise of relay itself may vary according to the mounting level or the heating method of reflow equipment. Therefore, please set the temperature of soldering portion of relay terminal and the top surface of the relay case not to exceed the above mentioned soldering condition.

It is recommended to check the temperature rise of each portion under actual mounting condition before use. The soldering earth shall be performed by manual soldering.

**7. Conditions for operation, transport and storage conditions**

1) Ambient temperature, humidity, and atmospheric pressure during usage, transport, and storage of the relay:

- (1) Temperature: -40 to +70°C -40 to +158°F
  - (2) Humidity: 5 to 85% RH (Avoid freezing and condensation.) The humidity range varies with the temperature. Use within the range indicated in the graph below.
  - (3) Atmospheric pressure: 86 to 106 kPa
- Temperature and humidity range for usage, transport, and storage:

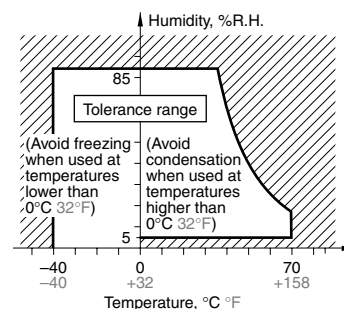

2) Condensation

Condensation forms when there is a sudden change in temperature under high temperature and high humidity conditions. Condensation will cause deterioration of the relay insulation.

3) Freezing

Condensation or other moisture may freeze on the relay when the temperature is lower than 0°C 32°F. This causes problems such as sticking of movable parts or operational time lags.

4) Low temperature, low humidity environments

The plastic becomes brittle if the relay is exposed to a low temperature, low humidity environment for long periods of time.

**For general cautions for use, please refer to the "General Application Guidelines".**

单击下面可查看定价，库存，交付和生命周期等信息

[>>Panasonic\(松下\)](#)