



FEATURES

- Best space savings in its class
- Large capacity switching despite small size. Can replace micro ISO terminal type relays.
- Terminals for PC board pattern designs are easily allocated.
- Sealed type

TYPICAL APPLICATIONS

Head lamp, Fog lamp, Fan motor, EPS, Defogger, Seat heater, etc.

ORDERING INFORMATION

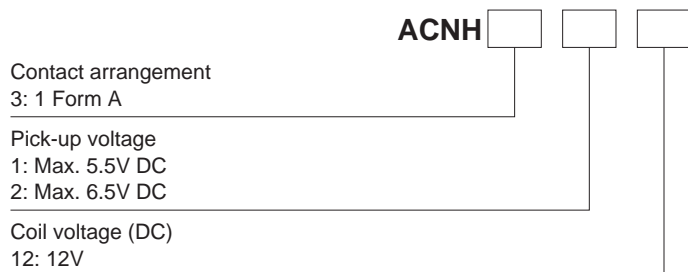

TYPES

Contact arrangement	Nominal coil voltage	Pick-up voltage (at 20°C 68°F)	Part No.
1 Form A	12V DC	Max. 6.5 V DC (Initial)	ACNH3212
		Max. 5.5 V DC (Initial)	ACNH3112

Standard packing; Carton (tube): 50 pcs.; Case: 1,000 pcs.

RATING

1. Coil data

Nominal coil voltage	Pick-up voltage (at 20°C 68°F)	Drop-out voltage (at 20°C 68°F)	Nominal operating current [±10%] (at 20°C 68°F)	Coil resistance [±10%] (at 20°C 68°F)	Nominal operating power (at 20°C 68°F)	Usable voltage range
12 V DC	Max. 6.5 V DC (Initial)	Min. 1.0 V DC (Initial)	37.5 mA	320%	450 mW	10 to 16 V DC
	Max. 5.5 V DC (Initial)	Min. 0.8 V DC (Initial)	53.3 mA	225%	640 mW	

CN-H (ACNH3)

2. Specifications

Characteristics	Item	Specifications	
Contact	Arrangement	1 Form A	
	Contact resistance (Initial)	Typ5mΩ (By voltage drop 6 V DC 1 A)	
	Contact material	Ag alloy (Cadmium free)	
Rating	Nominal switching capacity (resistive load)	30A 14V DC	
	Max. carrying current	<450mW> 35A/1 h, 45A/2 min. at 20°C 68°F 30A/1 h, 40A/2 min. at 85°C 185°F 25A/1 h, 35A/2 min. at 110°C 230°F	
		<640mW> 30A/1 h, 40A/2 min. at 20°C 68°F 25A/1 h, 35A/2 min. at 85°C 185°F 20A/1 h, 30A/2 min. at 110°C 230°F	
		Continuous carrying current	20A 14V DC (450mW) at 110°C 230°F, 15A 14V DC (640mW) at 110°C 230°F
		Nominal operating power	450 mW (for pick-up voltage max. 6.5 V DC), 640 mW (for pick-up voltage max. 5.5 V DC)
Min. switching capacity (resistive load)*1	1A 14V DC		
Electrical characteristics	Insulation resistance (Initial)	Min. 100 MΩ (at 500V DC, Measurement at same location as "Breakdown voltage" section.)	
	Breakdown voltage (Initial)	Between open contacts	500 Vrms for 1 min. (Detection current: 10mA)
		Between contacts and coil	500 Vrms for 1 min. (Detection current: 10mA)
	Operate time (at nominal voltage)	Max. 10ms (at 20°C 68°F, excluding contact bounce time) (Initial)	
Release time (at nominal voltage)	Max. 10ms (at 20°C 68°F) (Initial) (without protective element)		
Mechanical characteristics	Shock resistance	Functional	Min. 100 m/s ² {10G} (Half-wave pulse of sine wave: 11ms; detection time: 10μs)
		Destructive	Min. 1,000 m/s ² {100G} (Half-wave pulse of sine wave: 6ms)
	Vibration resistance	Functional	10 Hz to 100 Hz, Min. 44.1m/s ² {4.5G} (Detection time: 10μs)
		Destructive	10 Hz to 500 Hz, Min. 44.1m/s ² {4.5G} Time of vibration for each direction; X, Y direction: 2 hours, Z direction: 4 hours
Expected life	Mechanical	Min. 10 ⁷ (at 120 cpm)	
	Electrical	<Resistive load> Min. 10 ⁵ (at nominal switching capacity, operating frequency: 1s ON, 1s OFF) <Motor load> Min. 3×10 ⁵ (at inrush 84 A, steady 18 A, 14 V DC operating frequency: ON 2s, OFF 5s) <Lamp load> Min. 2×10 ⁵ (at inrush 84 A, steady 12 A, 14 V DC operating frequency: ON 1s, OFF 14s)	
Conditions	Conditions for operation, transport and storage	Ambient temperature: -40°C to +110°C -40°F to +230°F Humidity: 2% R.H. to 85% R.H. (Not freezing and condensing at low temperature)	
Mass		Approx. 9 g .32 oz	

Notes:

*1. This value can change due to the switching frequency, environmental conditions, and desired reliability level, therefore it is recommended to check this with the actual load.

REFERENCE DATA

1-(1). Coil temperature rise

Sample: ACNH3212, 3pcs
Measured portion: Inside the coil
Contact carrying current: 10A, 20A, 30A
Ambient temperature: 25°C 77°F

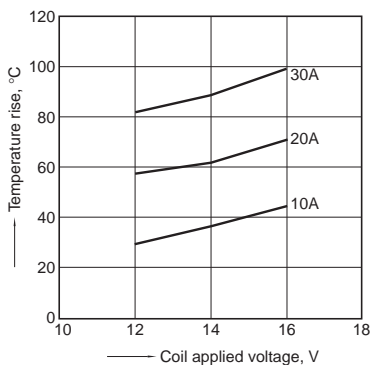

1-(2). Coil temperature rise

Sample: ACNH3212, 3pcs
Measured portion: Inside the coil
Contact carrying current: 10A, 20A
Ambient temperature: 110°C 230°F

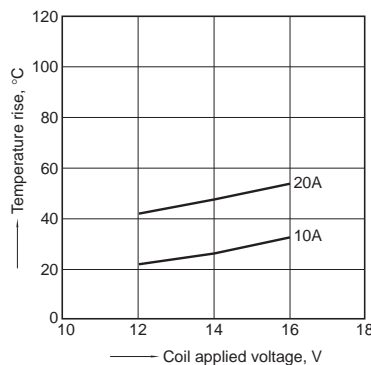

2. Ambient temperature and operating voltage range

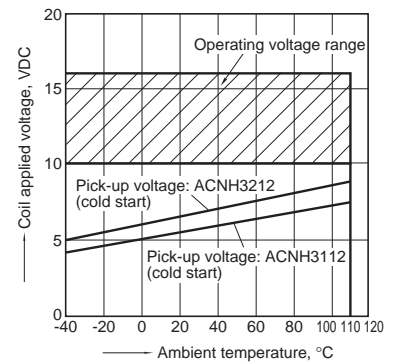

3-(1). Distribution of pick-up and drop-out voltage

Sample: ACNH3212, 20pcs.

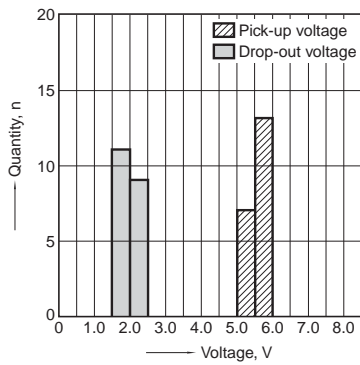

3-(2). Distribution of pick-up and drop-out voltage

Sample: ACNH3112, 20pcs.

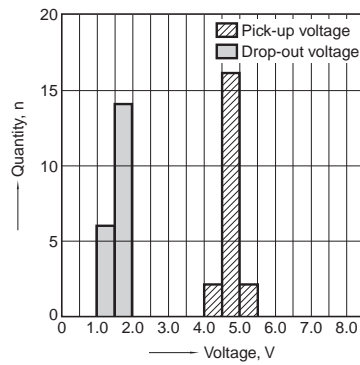

4-(1). Distribution of operate and release time

Sample: ACNH3212, 20pcs.

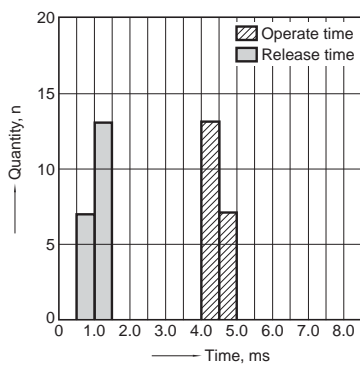

4-(2). Distribution of operate and release time

Sample: ACNH3112, 20pcs.

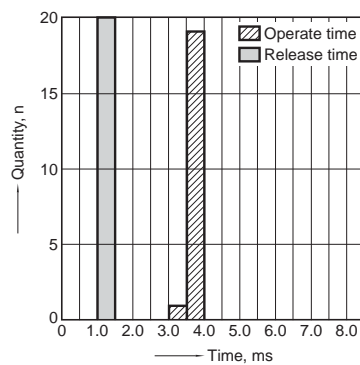

5. Electrical life test (Resistive load)

Sample: ACNH3212, 6pcs.

Load: Resistive load (NO side: 30A 14V DC)
 Operating frequency: ON 1s, OFF 1s
 Ambient temperature: Room temperature

Circuit:

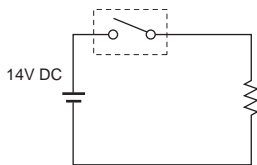

Change of pick-up and drop-out voltage

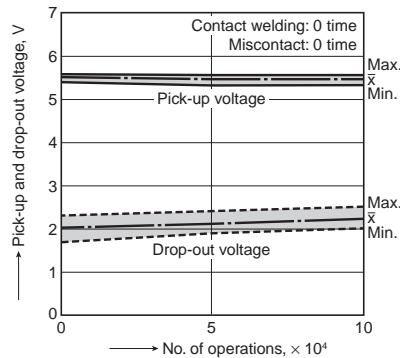

Change of contact resistance

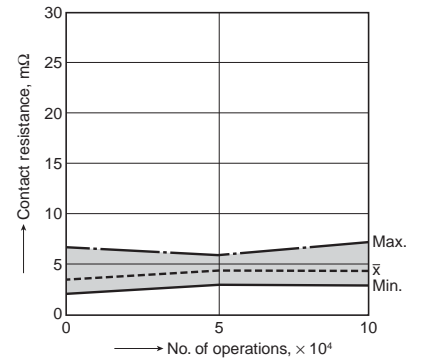

6-(1). Electrical life test (Motor load)

Sample: ACNH3212, 3pcs.

Load: inrush: 84A/steady: 18A,
 radiator fan actual load (motor free)
 Operating frequency: ON 2s, OFF 5s
 Ambient temperature: 110°C 230°F

Circuit:

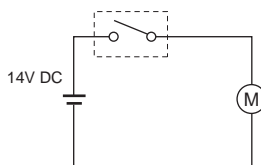

Change of pick-up and drop-out voltage

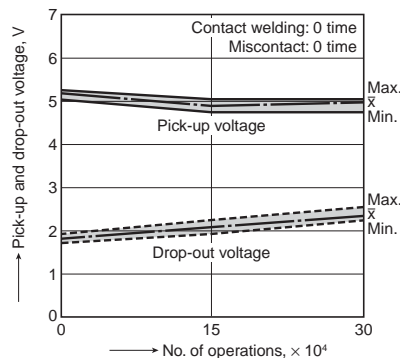

Change of contact resistance

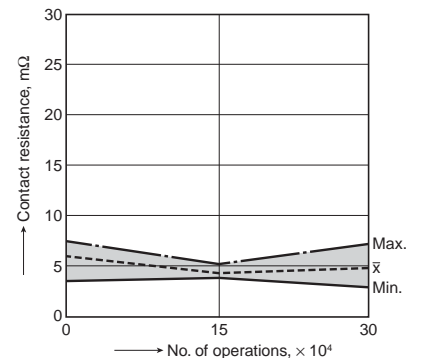

CN-H (ACNH3)

6-(2). Electrical life test (Lamp load)

Sample: ACNH3212, 6pcs.
 Load: 60W×2, inrush: 84A/steady: 12A
 Operating frequency: ON 1s, OFF 14s
 Ambient temperature: Room temperature

Circuit:

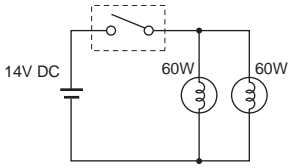

Change of pick-up and drop-out voltage

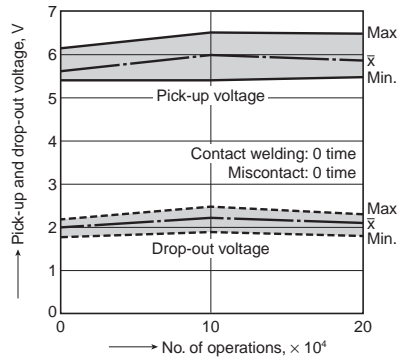

Change of contact resistance

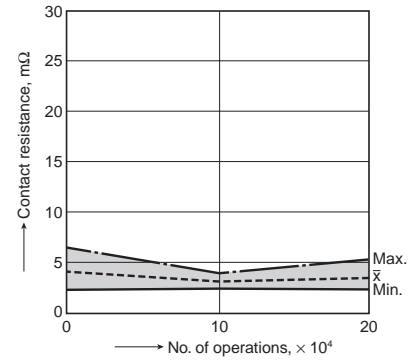

DIMENSIONS (mm inch)

Download [CAD Data](#) from our Web site.

[CAD Data](#)

External dimensions

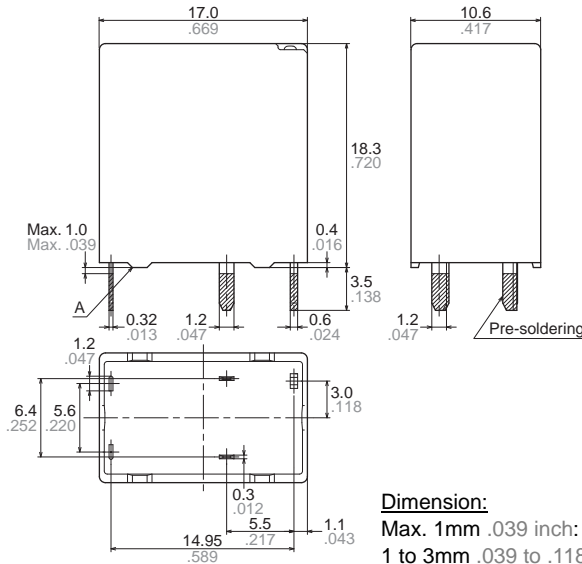

Dimension:	General tolerance
Max. 1mm .039 inch:	±0.1 ±.004
1 to 3mm .039 to .118 inch:	±0.2 ±.008
Min. 3mm .118 inch:	±0.3 ±.012

PC board pattern (Bottom view)

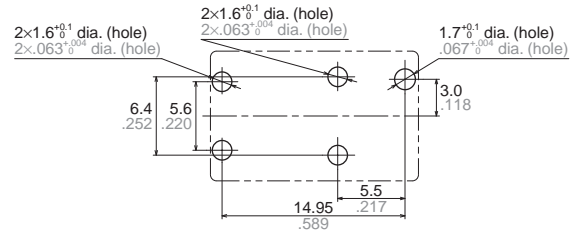

Tolerance: ±0.1 ±.004

Schematic (Bottom view)

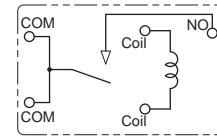

* Dimensions (thickness and width) of terminal is measured before pre-soldering.
 Intervals between terminals is measured at A surface level.

NOTES

Usage, transport and storage conditions

1) Ambient temperature, humidity, and atmospheric pressure during usage, transport, and storage of the relay:

- (1) Temperature: -40 to +110°C -40 to +230°F
- (2) Humidity: 2 to 85% RH (Avoid freezing and condensation.)
- (3) Atmospheric pressure: 86 to 106 kPa

The humidity range varies with the temperature. Use within the range indicated in the graph below.
 (Temperature and humidity range for usage, transport, and storage)

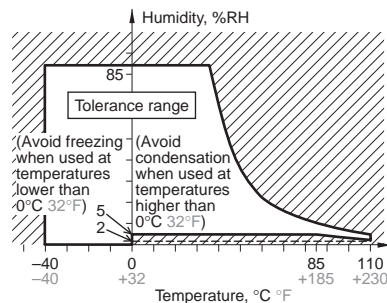

For Cautions for Use, see [Relay Technical Information](#).

单击下面可查看定价，库存，交付和生命周期等信息

[>>Panasonic\(松下\)](#)