

For board-to-FPC	A4S
Narrow pitch connectors (0.4mm pitch)	

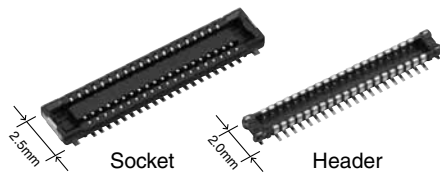

RoHS compliant

FEATURES

1. Width 2.5 mm slim two-piece type connector

Compact and slim structure contributes overall miniaturization of product design. <Compared to F4S (40 pins, when mated)>

- Width: 30% down
- Footprint: 30% down



2. "TOUGH CONTACT" ensures high resistance to various environments in lieu of slim and low profile body

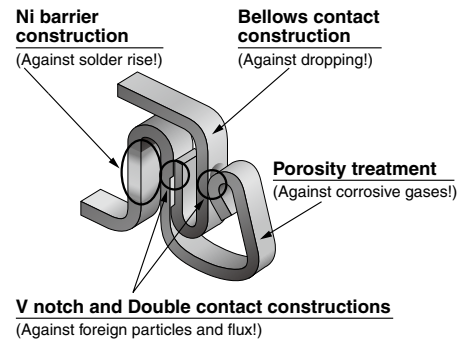

- 3. Mated heights of 0.8 and 1.0 mm are available for the same foot pattern.**
- 4. Connectors for inspection available**

APPLICATIONS

Board-to-FPC connections of mobile equipment (cellular phones, smart phones, laptops, and portable music players, etc.)

ORDERING INFORMATION

	AXE				2		
5: Narrow Pitch Connector A4S (0.4 mm pitch) Socket							
6: Narrow Pitch Connector A4S (0.4 mm pitch) Header							
Number of pins (2 digits)							
Mated height							
<Socket>							
1: For mated height 0.8/1.0 mm							
<Header>							
1: For mated height 0.8 mm							
2: For mated height 1.0 mm							
Functions							
2: Without positioning bosses							
Surface treatment (Contact portion / Terminal portion)							
<Socket>							
7: Ni plating on base, Au plating on surface (for Ni barrier available)							
<Header>							
4: Ni plating on base, Au plating on surface							
Package							
Nil: Embossed packaging (8 mm pitch)							
D: Embossed packaging (4 mm pitch)							

PRODUCT TYPES

■ 8 mm pitch embossed packaging

Mated height	Number of pins	Part number		Packing		
		Socket	Header	Inner carton (1-reel)	Outer carton	
0.8mm	10	AXE510127	AXE610124	5,000 pieces	10,000 pieces	
	12	AXE512127	AXE612124			
	14	AXE514127	AXE614124			
	16	AXE516127	AXE616124			
	18	AXE518127	AXE618124			
	20	AXE520127	AXE620124			
	22	AXE522127	AXE622124			
	24	AXE524127	AXE624124			
	26	AXE526127	AXE626124			
	28	AXE528127	AXE628124			
	30	AXE530127	AXE630124			
	32	AXE532127	AXE632124			
	34	AXE534127	AXE634124			
	36	AXE536127	AXE636124			
	40	AXE540127	AXE640124			
	44	AXE544127	AXE644124			
	1.0mm	50	AXE550127			AXE650124
		54	AXE554127			AXE654124
60		AXE560127	AXE660124			
64		AXE564127	AXE664124			
70		AXE570127	AXE670124			
80		AXE580127	AXE680124			
10		AXE510127	AXE610224			
12		AXE512127	AXE612224			
14		AXE514127	AXE614224			
20		AXE520127	AXE620224			
24		AXE524127	AXE624224			
26		AXE526127	AXE626224			
30		AXE530127	AXE630224			
32		AXE532127	AXE632224			
40	AXE540127	AXE640224				
44	AXE544127	AXE644224				
50	AXE550127	AXE650224				
54	AXE554127	AXE654224				
60	AXE560127	AXE660224				
70	AXE570127	AXE670224				
80	AXE580127	AXE680224				

- Notes: 1. Order unit:
 For volume production: 1-inner carton (1-reel) units
 For samples, please contact our sales office.
 2. Please contact us for connectors having a number of pins other than those listed above.

■ 4 mm pitch embossed packaging

Mated height	Number of pins	Part number		Packing	
		Socket	Header	Inner carton (1-reel)	Outer carton
0.8mm	10	AXE510127D	AXE610124D	15,000 pieces	30,000 pieces
	12	AXE512127D	AXE612124D		
	14	AXE514127D	AXE614124D		
	16	AXE516127D	AXE616124D		
	20	AXE520127D	AXE620124D		
	24	AXE524127D	AXE624124D		
	30	AXE530127D	AXE630124D		
	34	AXE534127D	AXE634124D		
	40	AXE540127D	AXE640124D		
	44	AXE544127D	AXE644124D		
	50	AXE550127D	AXE650124D		
	60	AXE560127D	AXE660124D		
	64	AXE564127D	AXE664124D		

- Notes: 1. Order unit:
 For volume production: 1-inner carton (1-reel) units
 For samples, please contact our sales office.
 2. Please contact us for connectors having a number of pins other than those listed above.

SPECIFICATIONS

■ Characteristics

Item		Specifications	Conditions																
Electrical characteristics	Rated current	0.3A/pin contact (Max. 5 A at total pin contacts)																	
	Rated voltage	60V AC/DC																	
	Dielectric strength	150V AC for 1 min.	No short-circuiting or damage at a detection current of 1 mA when the specified voltage is applied for one minute.																
	Insulation resistance	Min. 1,000MΩ (initial)	Using 250V DC megger (applied for 1 min.)																
	Contact resistance	Max. 90mΩ	Based on the contact resistance measurement method specified by JIS C 5402.																
Mechanical characteristics	Composite insertion force	Max. 1.200N/pin contact × pin contacts (initial)																	
	Composite removal force	Min. 0.165N/pin contact × pin contacts																	
	Contact holding force (Socket contact)	Min. 0.20N/pin contact	Measuring the maximum force. As the contact is axially pull out.																
Environmental characteristics	Ambient temperature	-55°C to +85°C	No icing or condensation.																
	Soldering heat resistance	Peak temperature: 260°C or less (on the surface of the PC board around the connector terminals)	Infrared reflow soldering																
		300°C within 5 sec. 350°C within 3 sec.	Soldering iron																
	Storage temperature	-55°C to +85°C (product only) -40°C to +50°C (emboss packing)	No icing or condensation.																
	Thermal shock resistance (header and socket mated)	5 cycles, insulation resistance min. 100MΩ, contact resistance max. 90mΩ	Conformed to MIL-STD-202F, method 107G																
			<table border="1"> <thead> <tr> <th>Order</th> <th>Temperature (°C)</th> <th>Time (minutes)</th> </tr> </thead> <tbody> <tr> <td>1</td> <td>-55₋₃⁰</td> <td>30</td> </tr> <tr> <td>2</td> <td>∕</td> <td>Max. 5</td> </tr> <tr> <td>3</td> <td>85₋₃⁰</td> <td>30</td> </tr> <tr> <td>4</td> <td>∕</td> <td>Max. 5</td> </tr> <tr> <td></td> <td>-55₋₃⁰</td> <td></td> </tr> </tbody> </table>	Order	Temperature (°C)	Time (minutes)	1	-55 ₋₃ ⁰	30	2	∕	Max. 5	3	85 ₋₃ ⁰	30	4	∕	Max. 5	
	Order	Temperature (°C)	Time (minutes)																
	1	-55 ₋₃ ⁰	30																
2	∕	Max. 5																	
3	85 ₋₃ ⁰	30																	
4	∕	Max. 5																	
	-55 ₋₃ ⁰																		
Humidity resistance (header and socket mated)	120 hours, insulation resistance min. 100MΩ, contact resistance max. 90mΩ	Conformed to IEC60068-2-78 Bath temperature 40°C±2°C, humidity 90% to 95% R.H.																	
Saltwater spray resistance (header and socket mated)	24 hours, insulation resistance min. 100MΩ, contact resistance max. 90mΩ	Conformed to IEC60068-2-11 Bath temperature 35°C±2°C, saltwater concentration 5%±1%																	
H ₂ S resistance (header and socket mated)	48 hours, contact resistance max. 90mΩ	Bath temperature 40°C±2°C, gas concentration 3 ppm ±1 ppm, humidity 75% to 80% R.H.																	
Lifetime characteristics	Insertion and removal life	30 times	Repeated insertion and removal speed of max. 200 times/hours																
Unit weight		20 pin contacts Socket: 0.02 g Header: 0.01 g																	

■ Material and surface treatment

Part name	Material	Surface treatment
Molded portion	LCP resin (UL94V-0)	—
Contact and Post	Copper alloy	Contact portion: Base: Ni plating Surface: Au plating Terminal portion: Base: Ni plating Surface: Au plating (except the terminal tips) The socket terminals close to the portion to be soldered have nickel barriers (exposed nickel portions). Soldering terminals: Sockets: Base: Ni plating Surface: Pd+Au flash plating (except the terminal tips) Headers: Base: Ni plating Surface: Au plating (except the terminal tips)

Narrow pitch connectors A4S (0.4mm pitch)

DIMENSIONS (Unit: mm)

The CAD data of the products with a **CAD Data** mark can be downloaded from: <http://industrial.panasonic.com/ac/e/>

Socket (Mated height: 0.8 mm/1.0 mm)

CAD Data

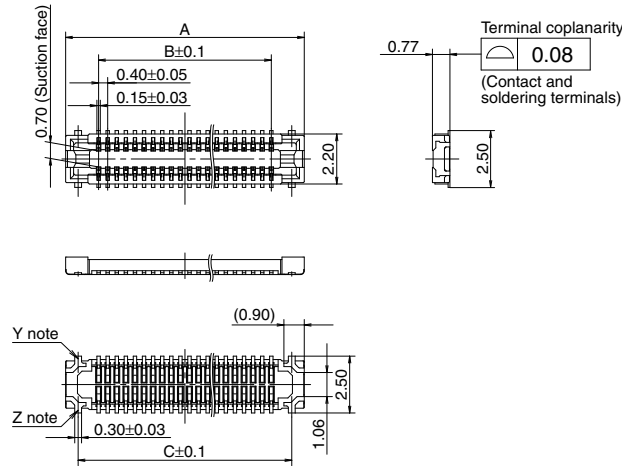

General tolerance: ± 0.2

Note: Since the soldering terminals has a single-piece construction, sections Y and Z are electrically connected.

Dimension table (mm)

Number of pins/ dimension	A	B	C
10	4.50	1.60	3.40
12	4.90	2.00	3.80
14	5.30	2.40	4.20
16	5.70	2.80	4.60
18	6.10	3.20	5.00
20	6.50	3.60	5.40
22	6.90	4.00	5.80
24	7.30	4.40	6.20
26	7.70	4.80	6.60
28	8.10	5.20	7.00
30	8.50	5.60	7.40
32	8.90	6.00	7.80
34	9.30	6.40	8.20
36	9.70	6.80	8.60
40	10.50	7.60	9.40
44	11.30	8.40	10.20
50	12.50	9.60	11.40
54	13.30	10.40	12.20
60	14.50	11.60	13.40
64	15.30	12.40	14.20
70	16.50	13.60	15.40
80	18.50	15.60	17.40

Header (Mated height: 0.8 mm)

CAD Data

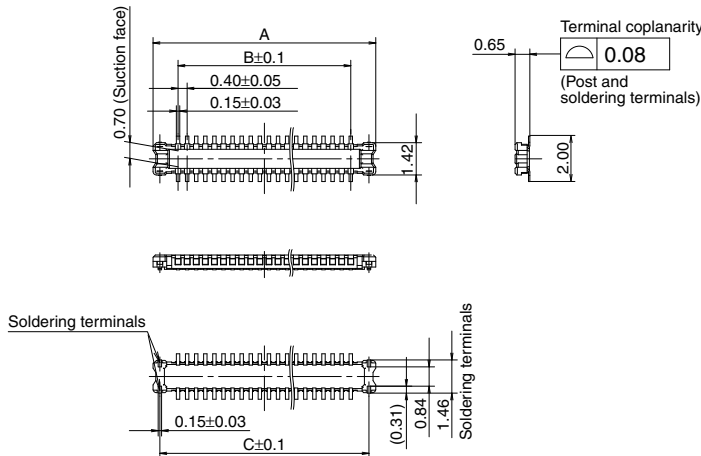

General tolerance: ± 0.2

Dimension table (mm)

Number of pins/ dimension	A	B	C
10	3.80	1.60	3.20
12	4.20	2.00	3.60
14	4.60	2.40	4.00
16	5.00	2.80	4.40
18	5.40	3.20	4.80
20	5.80	3.60	5.20
22	6.20	4.00	5.60
24	6.60	4.40	6.00
26	7.00	4.80	6.40
28	7.40	5.20	6.80
30	7.80	5.60	7.20
32	8.20	6.00	7.60
34	8.60	6.40	8.00
36	9.00	6.80	8.40
40	9.80	7.60	9.20
44	10.60	8.40	10.00
50	11.80	9.60	11.20
54	12.60	10.40	12.00
60	13.80	11.60	13.20
64	14.60	12.40	14.00
70	15.80	13.60	15.20
80	17.80	15.60	17.20

■ Header (Mated height: 1.0 mm)

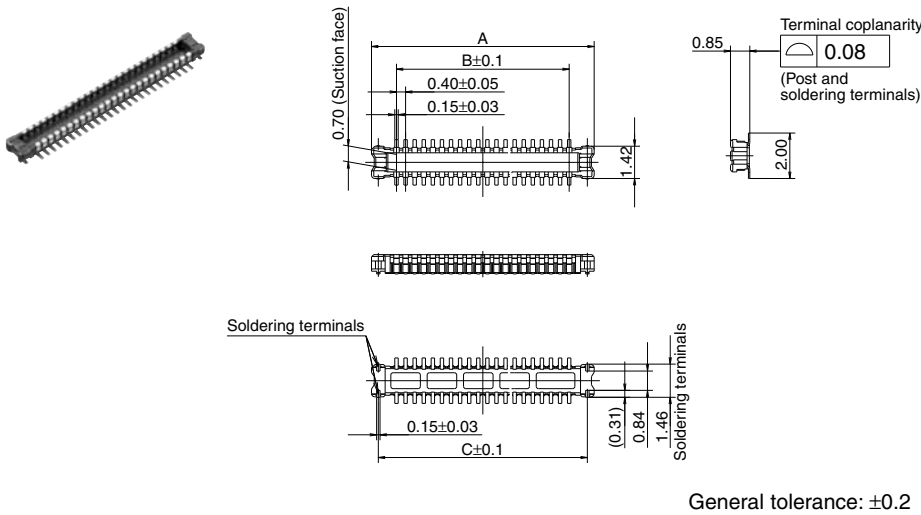

Dimension table (mm)

Number of pins/ dimension	A	B	C
10	3.80	1.60	3.20
12	4.20	2.00	3.60
14	4.60	2.40	4.00
20	5.80	3.60	5.20
24	6.60	4.40	6.00
26	7.00	4.80	6.40
30	7.80	5.60	7.20
32	8.20	6.00	7.60
40	9.80	7.60	9.20
44	10.60	8.40	10.00
50	11.80	9.60	11.20
54	12.60	10.40	12.00
60	13.80	11.60	13.20
70	15.80	13.60	15.20
80	17.80	15.60	17.20

■ Socket and Header are mated

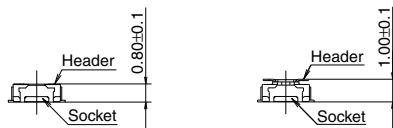

EMBOSSED TAPE DIMENSIONS (Unit: mm)

■ Specifications for taping

(In accordance with JIS C 0806-3:1999. However, not applied to the mounting-hole pitch of some connectors.)

■ Specifications for the plastic reel

(In accordance with EIAJ ET-7200B.)

• 8 mm pitch embossed packaging

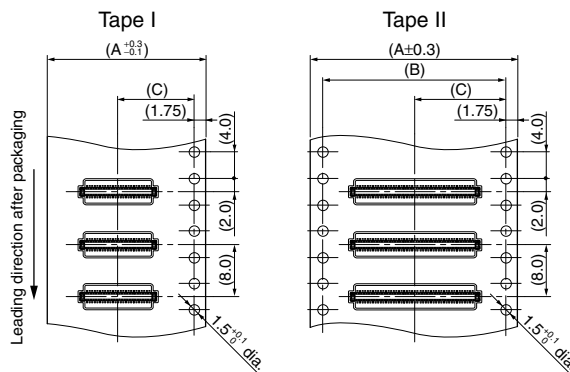

• 4 mm pitch embossed packaging

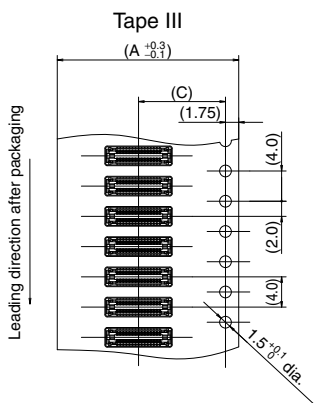

Narrow pitch connectors **A4S** (0.4mm pitch)

■ Dimension table (Unit: mm)

• 8 mm pitch embossed packaging

Type/Mated height	Number of pins	Type of taping	A	B	C	D	Quantity per reel
Common for sockets and headers 0.8 mm/1.0 mm	Max. 24	Tape I	16.0	—	7.5	17.4	5,000
	26 to 70	Tape I	24.0	—	11.5	25.4	5,000
	80	Tape II	32.0	28.4	14.2	33.4	5,000

• 4 mm pitch embossed packaging

Type/Mated height	Number of pins	Type of taping	A	B	C	D	Quantity per reel
Common for sockets and headers 0.8 mm	Max. 24	Tape III	16.0	—	7.5	17.4	15,000
	30 to 64	Tape III	24.0	—	11.5	25.4	15,000

■ Connector orientation with respect to embossed tape feeding direction

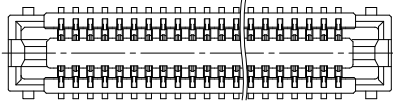
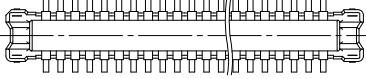
Direction of tape progress 	Type	Common for A4S	
	Socket	Header	
			

Note: There is no indication on this product regarding top-bottom or left-right orientation.

For board-to-FPC	A4S
Connectors for inspection usage (0.4mm pitch)	

FEATURES

1. **3,000 mating and unmating cycles**
2. **Same external dimensions and foot pattern as standard type.**
3. **Improved mating**
Insertion and removal easy due to a reduction in mating retention force. This is made possible by a simple locking structure design.

APPLICATIONS

Ideal for module unit inspection and equipment assembly inspection
 Note: Mating retention force cannot be warranted.
 Please avoid using for applications other than inspection.

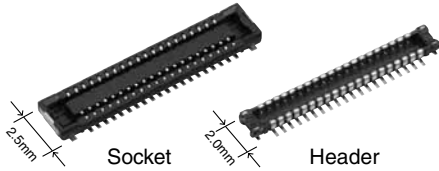

RoHS compliant

TABLE OF PRODUCT TYPES

☆: Available for sale

Product name	Number of pins																						
A4S for inspection	10	12	14	16	18	20	22	24	26	28	30	32	34	36	40	44	50	54	60	64	70	80	
	☆	☆	☆	☆	☆	☆	☆	☆	☆	☆	☆	☆	☆	☆	☆	☆	☆	☆	☆	☆	☆	☆	☆

- Notes: 1. Please inquire about number of pins other than those shown above.
 2. Please inquire with us regarding availability.
 3. Please keep the minimum order quantities no less than 50 pieces per lot.
 4. Please inquire if further information is needed.

PRODUCT TYPES

Specifications	Part No.	Specifications	Part No.
Socket	Without positioning bosses	Header	Without positioning bosses
	AXE5E**26		AXE6E**26

Note: When placing an order, substitute the "*" (asterisk) in the above part number with the number of pins for the specific connector.

NOTES

Recommended PC board and metal mask patterns

Connectors are mounted with high pitch density, intervals of 0.35 mm, 0.4 mm or 0.5 mm.

In order to reduce solder and flux rise, solder bridges and other issues make sure the proper levels of solder is used. The figures to the right are recommended metal mask patterns. Please use them as a reference.

Socket (Mated height: 0.8mm/1.0mm) Recommended PC board pattern (TOP VIEW)

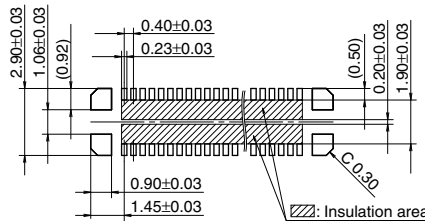

Recommended metal mask pattern
 Metal mask thickness: When 120μm
 (Terminal opening ratio: 70%)
 (Metal-part opening ratio: 70%)

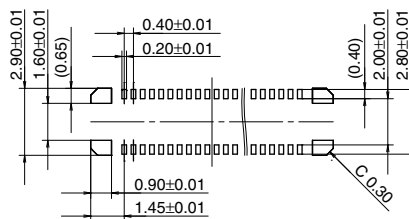

Header (Mated height: 0.8mm/1.0mm) Recommended PC board pattern (TOP VIEW)

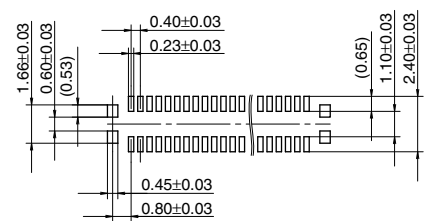

Recommended metal mask pattern
 Metal mask thickness: When 120μm
 (Terminal opening ratio: 70%)
 (Metal-part opening ratio: 100%)



Please refer to the latest product specifications when designing your product.

For board-to-board/board-to-FPC

Notes on Using Narrow pitch Connectors/ High Current Connectors

About safety Remarks

- 1) Do not use these connectors beyond the specification sheets. The usage outside of specified rated current, dielectric strength, and environmental conditions and so on may cause circuitry damage via abnormal heating, smoke, and fire.
- 2) In order to avoid accidents, your thorough specification review is appreciated. Please contact us if your usage is out of the specifications. Otherwise, Panasonic

Corporation cannot guarantee the quality and reliability.
3) Panasonic Corporation is consistently striving to improve quality and reliability. However, the fact remains that electrical components and devices generally cause failures at a given statistical probability. Furthermore, their durability varies with use environments or use conditions. In this respect, please check for actual electrical components and devices under actual conditions before use.

Continued usage in a state of degraded condition may cause the deteriorated insulation, thus result in abnormal heat, smoke or firing. Please carry out safety design and periodic maintenance including redundancy design, design for fire spread prevention, and design for malfunction prevention so that no accidents resulting in injury or death, fire accidents, or social damage will be caused as a result of failure of the products or ending life of the products.

Regarding the design of devices and PC board patterns

- 1) When using the board to board connectors, do not connect a pair of board with multiple connectors. Otherwise, misaligned connector positions may cause mating failure or product breakage.
- 2) With mounting equipment, there may be up to a ± 0.2 to 0.3-mm error in positioning. Be sure to design PC boards and patterns while taking into consideration the performance and abilities of the required equipment.
- 3) Some connectors have tabs embossed on the body to aid in positioning. When using these connectors, make sure that the PC board is designed with positioning holes to match these tabs.
- 4) To ensure the required mechanical strength when soldering the connector terminals, make sure the PC board meets recommended PC board pattern design dimensions given.
- 5) PC board
Control the thicknesses of the coverlay and adhesive to prevent poor soldering. This connector has no stand-off.

Therefore, minimize the thickness of the coverlay, etc. so as to prevent the occurrence of poor soldering.

- 6) For all connectors of the narrow pitch series, to prevent the PC board from coming off during vibrations or impacts, and to prevent loads from falling directly on the soldered portions, be sure to design some means to fix the PC board in place.

Example) Secure in place with screws

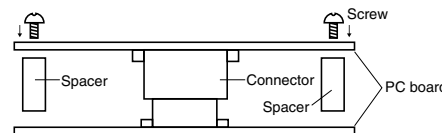

When connecting PC boards, take appropriate measures to prevent the connector from coming off.

- 7) When mounting connectors on a FPC board:
 - When the connector soldered to FPC is mated or unmated, solder detachment may occur by the force to the terminals. Connector handling is recommended in

the condition when the reinforcing plate is attached to the backside of FPC where the connector is mounted. The external dimension of the reinforcing plate is recommended to be larger than the dimension of "PC board recommended process pattern" (extended dimension of one side is approximately 0.5 to 1.0 mm). The materials and thickness of the reinforcing plate are glass epoxy or polyimide (thickness 0.2 - 0.3 mm) or SUS (thickness 0.1 - 0.2 mm).

- As this connector has temporary locking structure, the connector mating may be separated by the dropping impact depend on the size, weight or bending force of the FPC. Please consider the measures at usage to prevent the mating separation.

- 8) The narrow pitch connector series is designed to be compact and thin. Although ease of handling has been taken into account, take care when mating the connectors, as displacement or angled mating could damage or deform the connector.

Regarding the selection of the connector placement machine and the mounting procedures

- 1) Select the placement machine taking into consideration the connector height, required positioning accuracy, and packaging conditions.
- 2) Be aware that if the chucking force of the placement machine is too great, it may deform the shape of the connector body or connector terminals.
- 3) Be aware that during mounting, external forces may be applied to the connector contact surfaces and terminals and cause deformations.

- 4) Depending on the size of the connector being used, self alignment may not be possible. In such cases, be sure to carefully position the terminal with the PC board pattern.
- 5) The positioning bosses give an approximate alignment for positioning on the PC board. For accurate positioning of the connector when mounting it to the PC board, we recommend using an automatic positioning machine.

- 6) In case of dry condition, please note the occurrence of static electricity. The product may be adhered to the embossed carrier tape or the cover tape in dry condition. Recommended humidity is from 40%RH to 60%RH and please remove static electricity by ionizer in manufacturing process.

Regarding soldering

■ Reflow soldering

- 1) Measure the recommended profile temperature for reflow soldering by placing a sensor on the PC board near the connector surface or terminals. (Please refer to the specification for detail because the temperature setting differs by products.)
- 2) As for cream solder printing, screen printing is recommended.
- 3) When setting the screen opening area and PC board foot pattern area, refer the recommended PC board pattern and window size of metal mask on the specification sheet, and make sure that the size of board pattern and metal mask at the base of the terminals are not increased.
- 4) Please pay attentions not to provide too much solder. It makes miss mating because of interference at soldering portion when mating.

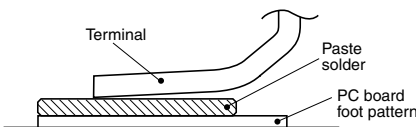

- 5) When mounting on both sides of the PC board and the connector is mounting on the underside, use adhesives or other means to ensure the connector is properly fixed to the PC board. (Double reflow soldering on the same side is possible.)
- 6) The condition of solder or flux rise and wettability varies depending on the type of solder and flux. Solder and flux characteristics should be taken into consideration and also set the reflow temperature and oxygen level.
- 7) Do not use resin-containing solder. Otherwise, the contacts might be firmly fixed.

8) Soldering conditions

Please use the reflow temperature profile conditions recommended below for reflow soldering. Please contact us before using a temperature profile other than that described below (e.g. lead-free solder).

- Narrow pitch connectors (except P8 type)

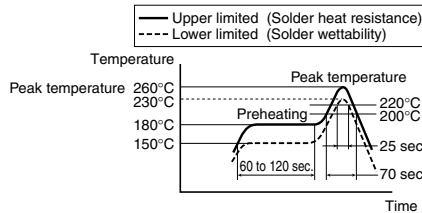

- Narrow pitch connector (P8)

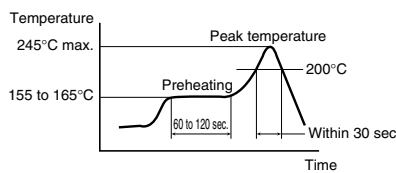

For products other than the ones above, please refer to the latest product specifications.

- 9) The temperature profiles given in this catalog are values measured when using the connector on a resin-based PC board. When performed reflow soldering on a metal board (iron, aluminum, etc.) or a metal table to mount on a FPC, make sure there is no deformation or discoloration of the connector before mounting.
- 10) Consult us when using a screen-printing thickness other than that recommended.

■ Hand soldering

- 1) Set the soldering iron so that the tip temperature is less than that given in the table below.

Table A

Product name	Soldering iron temperature
SMD type connectors	300°C within 5 sec. 350°C within 3 sec.

- 2) Do not allow flux to spread onto the connector leads or PC board. This may lead to flux rising up to the connector inside.
- 3) Touch the soldering iron to the foot pattern. After the foot pattern and connector terminal are heated, apply the solder wire so it melts at the end of the connector terminals.

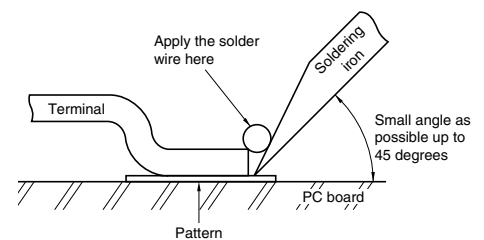

- 4) Be aware that soldering while applying a load on the connector terminals may cause improper operation of the connector.
- 5) Thoroughly clean the soldering iron.
- 6) Flux from the solder wire may get on the contact surfaces during soldering operations. After soldering, carefully check the contact surfaces and clean off any solder before use.
- 7) These connector is low profile type. If too much solder is supplied for hand soldering, It makes miss mating because of interference at soldering portion. Please pay attentions.

■ Solder reworking

- 1) Finish reworking in one operation.
- 2) In case of soldering rework of bridges. Don't use supplementary solder flux. Doing so may cause contact problems by flux.
- 3) Keep the soldering iron tip temperature below the temperature given in Table A.

Handling Single Components

- 1) Make sure not to drop or allow parts to fall from work bench.
- 2) Excessive force applied to the terminals could cause warping, come out, or weaken the adhesive strength of the solder. Handle with care.
- 3) Do not insert or remove the connector when it is not soldered. Forcibly applied external pressure on the terminals can weaken the adherence of the terminals to the molded part or cause the terminals to lose their evenness.

Precautions for mating

This product is designed with ease of handling. However, in order to prevent the deformation or damage of contacts and molding, take care and do not mate the connectors as shown right.

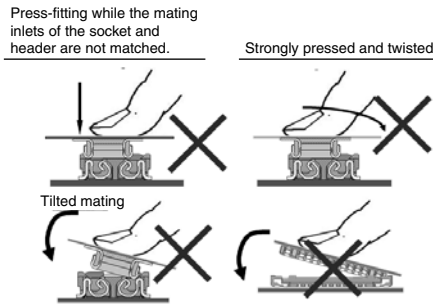

Cleaning flux from PC board

There is no need to clean this product. If cleaning it, pay attention to the following points to prevent the negative effect to the product.

1) Keep the cleaning solvent clean and prevent the connector contacts from contamination.

2) Some cleaning solvents are strong and they may dissolve the molded part and characters, so pure water passed liquid solvent is recommended.

Handling the PC board after mounting the connector

When cutting or bending the PC board after mounting the connector, be careful that the soldered sections are subjected to excessive force.

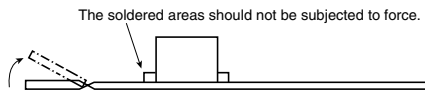

Storage of connectors

1) To prevent problems from voids or air pockets due to heat of reflow soldering, avoid storing the connectors in areas of high humidity.

2) Depending on the connector type, the color of the connector may vary from connector to connector depending on when it is produced.

Some connectors may change color slightly if subjected to ultraviolet rays during storage. This is normal and will not affect the operation of the connector.

3) When storing the connectors with the PC boards assembled and components already set, be careful not to stack them up so the connectors are subjected to

excessive forces.

4) Avoid storing the connectors in locations with excessive dust. The dust may accumulate and cause improper connections at the contact surfaces.

Other Notes

1) Do not remove or insert the electrified connector (in the state of carrying current or applying voltage).

2) Dropping of the products or rough mishandling may bend or damage the terminals and possibly hinder proper reflow soldering.

3) Before soldering, try not to insert or remove the connector more than absolutely necessary.

4) When coating the PC board after soldering the connector to prevent the deterioration of insulation, perform the coating in such a way so that the coating does not get on the connector.

5) There may be variations in the colors of products from different production lots. This is normal.

6) The connectors are not meant to be used for switching.

7) Product failures due to condensation are not covered by warranty.

Regarding sample orders to confirm proper mounting

When ordering samples to confirm proper mounting with the placement machine, connectors are delivered in 50-piece units in the condition given right. Consult a sale representative for ordering sample units.

Condition when delivered from manufacturing



Embossed tape amount required for the mounting

Required number of products for sample production (Unit 50 pcs.)

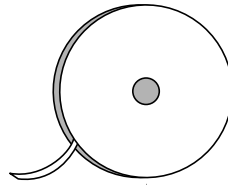

Reel

(Delivery can also be made on a reel by customer request.)

Please refer to the latest product specifications when designing your product.

Please contact

Panasonic Corporation

Electromechanical Control Business Division

■ 1006, Oaza Kadoma, Kadoma-shi, Osaka 571-8506, Japan
industrial.panasonic.com/ac/e/

Panasonic®

©Panasonic Corporation 2016

单击下面可查看定价，库存，交付和生命周期等信息

[>>Panasonic\(松下\)](#)