

Perfect fit for small devices

Capable of controlling a device which requires multiple-axis synchronous control (up to eight axes)

FP0H Positioning RTEX units

AFP0HM4N (4-axis type)

AFP0HM8N (8-axis type)

RTEX

Realtime Express

Full suite of motion functions

Multi-axis synchronous control



■ **Electronic gear**
The electronic gear function changes the master axis and slave axis speed ratio.



■ **Electronic clutch**
The electronic clutch function is used to engage the clutch.



■ **Electronic cam**
The electronic cam function determines and outputs the movement amount of the slave axis according to the operation of the master axis and cam pattern.

Interpolation control



■ **2-axis and 3-axis linear interpolation controls**



■ **2-axis circular interpolation control**



■ **3-axis spiral interpolation control**

Pulsar input function

By connecting pulsers, operations on each axis can be controlled manually.

- Number of channel: Max. 3 channels
- Counting area:
-2,147,483,648 to 2,147,483,647 pulses
- Input mode:
Phase input, Direction discrimination input and Individual input (Multiplier function for each mode)

RTEX communication

Command update cycle: 1 ms / 8 axes

Capable of controlling up to 16 axes with a small PLC

* Up to eight axes for synchronous control

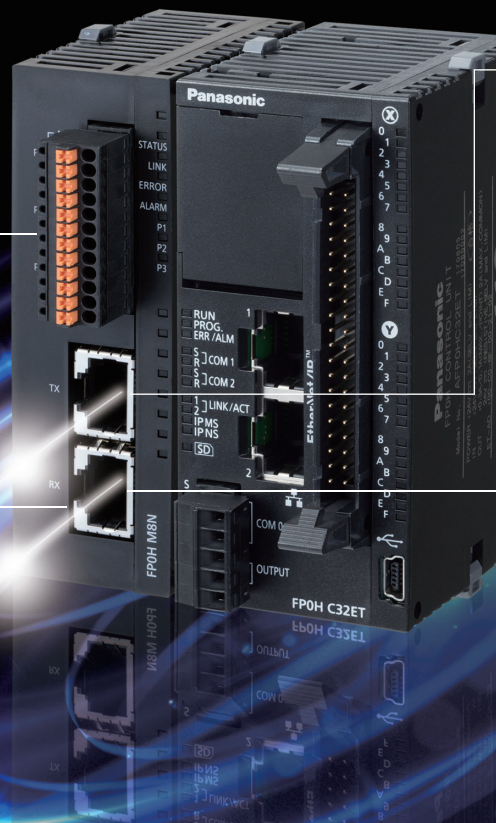

Network servo drivers
MINAS A5N/A6N supported



Capable of performing motion control through a high-speed network and supporting an open network with a small PLC

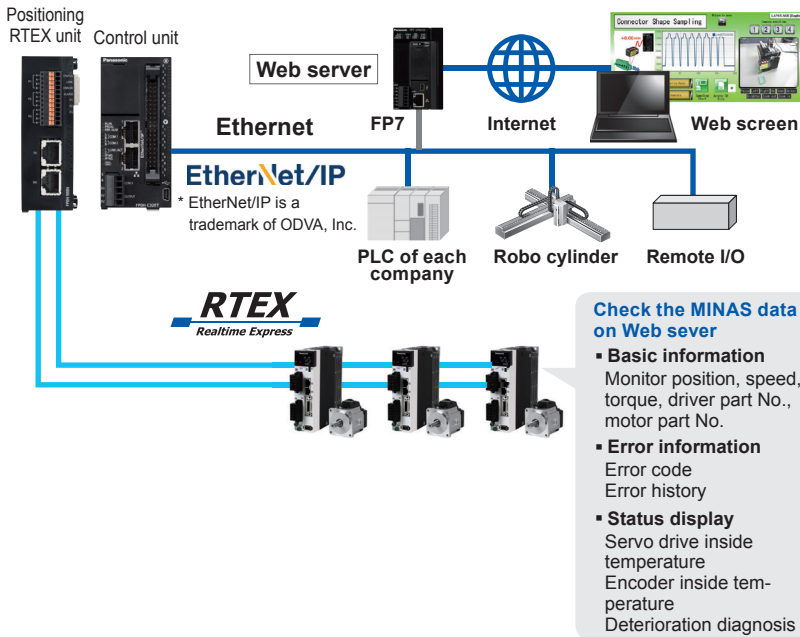

Features

Support of network servo drivers MINAS A5N/A6N significantly reduces the man-hours in wiring.

A maximum of 16 axes. Up to two 8-axis units can be installed.

*Synchronous control

4-axis type: Up to six axes including virtual axes (virtual axis: 2 axes)

8-axis type: Up to eight axes including virtual axes

Control unit

Compatible with EtherNet/IP, Modbus-TCP and MC protocol

Easily connected to various robots and PLCs for performing control and communication

Monitors status through the network

Capable of obtaining data to monitor the status of the motor and perform predictive maintenance

Features of RTEX (Realtime Express)

Simpler wiring: cuts labor time for design and installation.

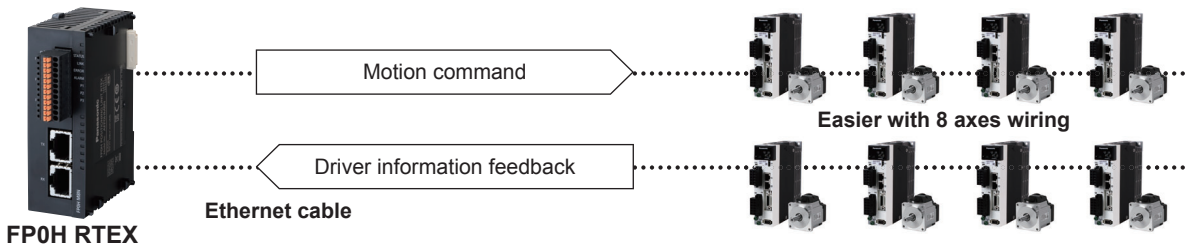

High speed network and high performance servo bring synchronous control

FP0H RTEX

Position (interpolation): Helical control

Synchronization: Gantry / Cam control

Command update period 1 ms / 8 axes

RTEX Realtime Express

Ethernet base

CAT5e cable

Highly immune to noise

MINASA6N

Frequency response: 3.2 kHz

Maximum speed: 6,500 r/min.

Max. pulse frequency: 4 Gpps, Resolution: 23 bits

Suitable for different applications

Control of gantry mechanism

2-axis gantry control together with interpolation control enables smooth and highly accurate stage control.

Y axis: Gantry X and Z axes: Circular and Linear interpolations

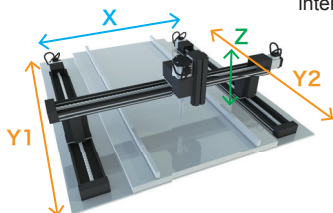

Main application sectors: Electronic parts, liquid crystal manufacturing, machine tools, etc.

Main application devices: Inspection equipment, coaters, laser scanners, etc.

Control of cam mechanism

Preset cam operation synchronized with the main axis enables control of the rotation of the slave axis motor.

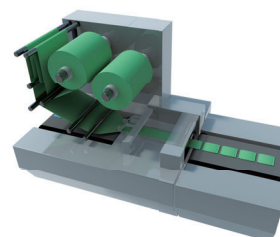

Main application sectors: Packaging equipment, food/chemicals, general machinery, etc.

Main application devices: Rotary cutters, printing machine, inserters, etc.

Full suite of convenient functions

1 Perfect for photographing by camera in a set position

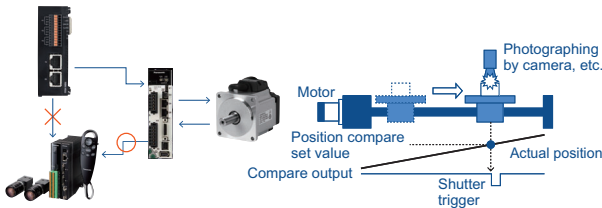

Highly accurate position compare

Turns trigger output ON in the position of the encoder of servo motor

Point

Capable of high-precision timing detection, because position comparison is performed inside the servo motor to avoid communication delay or calculation lag with the controller

2 Perfect for press fitting control with torque stopping

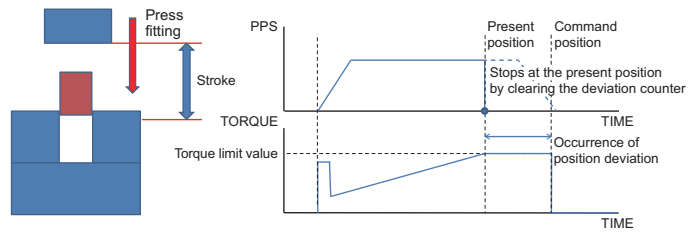

Deviation counter clearing

Capable of simple press fitting control (torque control) by combining the torque control function at the position control. Stops the motor with the torque limit value, and then stops the occurrence of torque.

Point

Stops the application of torque. Capable of immediate inversion operation as there is no accumulated pulse in the deviation counter.

3 Perfect for cueing hoop material

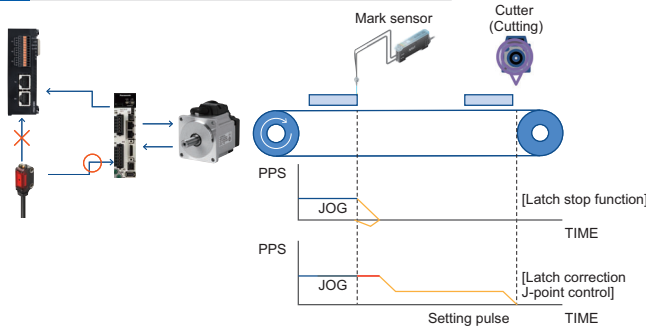

Latch stop function

Stops the motor immediately by turning ON the sensor signal connected to the servo driver.

Latch correction J-point control

Stops the motor at a set amount of movement, after turning ON the sensor signal connected to the servo driver.

Point

Capable of stopping with high accuracy, because the sensor signal is directly input into the servo driver to avoid communication delay or calculation lag with the controller via the network.

Programming software

Control FFWIN Pro7

International standard IEC 61131-3 compliant
Programming software of PLC open certification

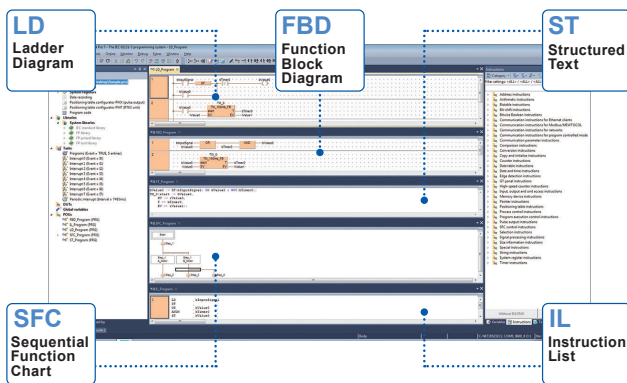

Features

- Five programming languages can be used.**
Programming can be done using the language most familiar to the developer or using the language most suited to the process to be performed. High-level (structured text) languages that allow structuring, such as C, are supported.
- Easy to reuse well-proven programs**
Efficiency when writing programs has been greatly increased by being able to split programming up for each function and process using structured programming.
- Keep know-how from getting out**
By "black boxing" a part of a program, you can prevent know-how from leaking out and improve the program's maintainability.
- Source program from PLC can be uploaded.**
Serviceability is improved by being able to read programs and comments from a PLC.
- Programming for all models in the FP series possible**

Capable of easily configure parameters and positioning actions by activating Configurator PM7-RTEX from Control FFWIN Pro7.

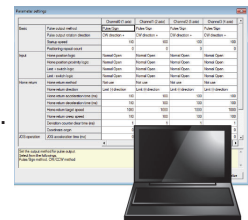

* For Configurator PM7-RTEX, supported from Control FFWIN Pro7 Ver.7.3.0.0 or later.

Support of FB library for positioning control

What is FB(Function Block)?

It is a function where a series of processing (programs) are compartmentalized and registered to be used as a single command.

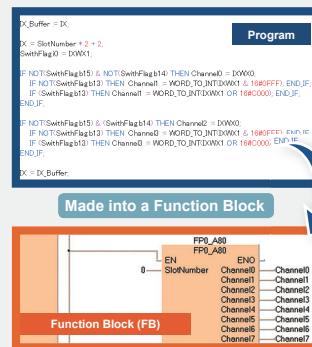

Function Block is to be released at our website.

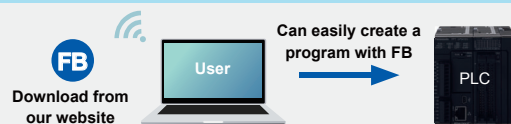

Specifications

Type		4-axis type	8-axis type	
Item	Part No.	AFP0HM4N	AFP0HM8N	
Number of axes controlled		4 axes	8 axes	
Interpolation control		2-axis linear interpolation, 2-axis circular interpolation, 3-axis linear interpolation and 3-axis spiral interpolation		
Occupied I/O points		128 input points, 128 output points		
Automatic operation	Position control	Position specification mode	Absolute (Absolute position specification), Increment (Relative position specification)	
		Position specified unit	µm (Min. unit of instruction selectable between 0.1 µm and 1 µm) inch (Min. unit of instruction selectable between 0.0001 inch and 0.0001 inch) degree (Min. unit of instruction selectable between 0.1 degree and 1 degree)	
		Position setting range	pulse	-2,147,482,624 to 2,147,482,624 pulse
			µm (0.1 µm)	-214,748,262.4 to 214,748,262.4 µm
			µm (1 µm)	-2,147,482,624 to 2,147,482,624 µm
			inch (0.0001 inch)	-21,474.82624 to 21,474.82624 inch
			inch (0.001 inch)	-214,748.2624 to 214,748.2624 inch
			degree (0.1 degree)	-214,748.2624 to 214,748.2624 degree
			degree (1 degree)	-2,147,482.624 to 2,147,482.624 degree
			Speed reference range	pulse : 1 to 2,147,482,624 pps µm : 1 to 2,147,482,624 µm/s inch : 0.001 to 2,147,482.624 inch/s degree: 0.001 to 2,147,482.624 rev/s
		Acceleration and deceleration method	Linear acceleration / deceleration, S acceleration / deceleration	
		Acceleration time	0 to 10,000 ms (Settable by 1 ms)	
		Deceleration time	0 to 10,000 ms (Settable by 1 ms)	
		No. of positioning tables	Each axis: 600 points in standard area and 89 points in extended area	
		Control method	Independent	PTP control (E-point control, C-point control), CP control (P-point control), Speed control (J-point control)
Linear interpolation	E point, P point, C point controls, Composite speed or Long axis speed			
Circular interpolation	Linear interpolation	E point, P point, C point controls, Center point or Pass point		
	Spiral interpolation	E point, P point, C point controls, Composite speed or Long axis speed		
Startup time	Standard area: 3 ms or less, Extended area: 5 ms or less			
Other functions	Dwell time	0 to 32,767 ms (Settable by 1 ms)		
Manual operation	JOG operation	Speed reference range	pulse : 1 to 2,147,482,624 pps µm : 1 to 2,147,482,624 µm/s inch : 0.001 to 2,147,482.624 inch/s degree: 0.001 to 2,147,482.624 rev/s	
		Acceleration / deceleration method	Linear acceleration / deceleration, S acceleration / deceleration	
		Acceleration time	0 to 10,000 ms (Settable by 1 ms)	
		Deceleration time	0 to 10,000 ms (Settable by 1 ms)	
	Home return *1	Speed reference range	pulse : 1 to 2,147,482,624 pps µm : 1 to 2,147,482,624 µm/s inch : 0.001 to 2,147,482.624 inch/s degree: 0.001 to 2,147,482.624 rev/s	
		Acceleration / deceleration method	Linear acceleration/deceleration	
		Acceleration time	0 to 10,000 ms (Settable by 1 ms)	
		Deceleration time	0 to 10,000 ms (Settable by 1 ms)	
	Return method	DOG method (3 types), Limit method (2 types), Data set method, Z phase method, Stop-on-contact method (2 types)		
		Pulsar operation	Speed reference range	Operation synchronized with inputs from pulsar
Stop function	Deceleration stop	Deceleration time	Deceleration time of the operation being active	
	Emergency stop	Deceleration time	0 to 10,000 ms (Settable by 1 ms)	
	Limit stop	Deceleration time	0 to 10,000 ms (Settable by 1 ms)	
	Error stop	Deceleration time	0 to 10,000 ms (Settable by 1 ms)	
	System stop	Deceleration time	Immediate stop (0 ms)	

Type		4-axis type	8-axis type	
Item	Part No.	AFP0HM4N	AFP0HM8N	
Synchronous functions	Supported functions	Electronic gear, Electronic clutch, Electronic cam		
		No. of axes	4 groups	
	Electronic gear	Master axis	Selectable from real axes, virtual axes and pulse inputs.	
		Slave axis	Max. 8 axes per master axis	
	Electronic clutch	Operation setting	Gear ratio setting	
		Operation method	Direct method, Linear acceleration / deceleration method	
	Electronic cam	Trigger type	Clutch ON trigger: Contact method Clutch OFF trigger: Contact input, The contact input + phase specification Contact method can be selected from the edge and level types.	
		Connection method	Direct method, Linear slide method	
	Cam curve	Resolution	Select from 20 types. Multiple curves can be specified within phase (0 to 100 %)	
		No. of cam patterns	1,024, 2,048, 4,096, 8,192, 16,384, 32,768	
Cam pattern configuration method	Cam curve method	4 to 16 (According to resolution)		
	Cam point method	Cam curve method, Cam point method (set from Configurator PM7-RTEX)		
Software limit function	Setting range	pulse	-2,147,482,624 to 2,147,482,624 pulse	
		µm (0.1 µm)	-214,748,262.4 to 214,748,262.4 µm	
		µm (1 µm)	-2,147,482,624 to 2,147,482,624 µm	
Monitor judgement	Torque judgement	Torque judgement: Selectable from Enabled / Disabled, Error / Warning 0.0 to 500.0 %		
	Actual speed judgement	Actual speed judgement: Selectable from Enabled / Disabled, Error / Warning 0 to 5,000 rpm		
Backup	Parameters and positioning data are saved in the flash memory. (Battery less)			
<ul style="list-style-type: none"> Limit input CWL, CCWL monitor, Proximity (DOG) monitor General-purpose input: 2 points, General-purpose output: 2 points (input and output from driver) Auxiliary output contact, Auxiliary output code Torque limit function 				

*1 "Servo motor with an absolute encoder" supported
 Absolute home return is performed in combination with A6-family servo motor with an absolute encoder.
 For servo drivers of A6NF and A6NE.
 Servo drivers with software of Ver. 1.24 (A6NF and A6NE) or later supported

Dimensions (Unit: mm in)

The CAD data can be downloaded from our website.

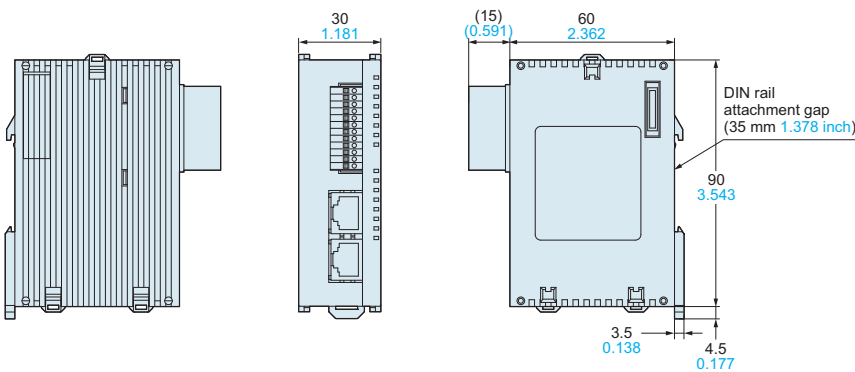

Please contact

Panasonic Corporation

Industrial Device Business Division
 ■ 1006, Oaza Kadoma, Kadoma-shi, Osaka 571-8506, Japan
industrial.panasonic.com/ac/e/

Panasonic®

©Panasonic Corporation 2019

单击下面可查看定价，库存，交付和生命周期等信息

[>>Panasonic\(松下\)](#)