

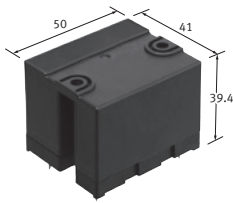

**Max. 1,000 V DC, 20 A
cut-off possible
High capacity
power relays**

HE-V RELAYS

Protective construction : Flux-resistant type



(Unit : mm)

FEATURES

- 1. Compact size**
(L: 41.0 × W: 50.0 × H: 39.4 mm
L: 1.614 × W: 1.969 × H: 1.551 inch)
Maximum 1,000 V DC, 20 A cut-off has been achieved (at each 1 Form A contact connected in series)

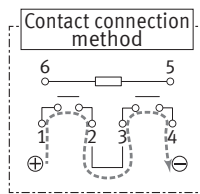

- 2. Contact arrangement: 2 Form A**
400 V DC, 20 A per 1 Form A
- 3. Contributes to energy saving in devices thanks to reduced coil hold voltage**

Coil hold voltage can be reduced down to 33% of the nominal coil voltage. This equals to operating power of approximately 210 mW.

*Coil hold voltage is the coil voltage after 100 ms following application of the nominal coil voltage.

TYPICAL APPLICATIONS

- 1. Photovoltaic power generation systems (PV inverters, PV combiners)**
• Suitable for NEC 2014 section 690.12 Rapid shut down
- 2. Battery charge and discharge systems**
- 3. Inverter control, DC load control, etc.**

ORDERING INFORMATION

HEV 2a N - P - DC

- Contact arrangement
2a : 2 Form A
(Single side stable type)
- Operate voltage
N : 70% of nominal voltage
- Terminal shape
P : PC board terminal type
- Nominal coil voltage (DC)
6, 9, 12, 15, 24V

TYPES

Nominal coil voltage	Part No.
6V DC	HEV2aN-P-DC6V
9V DC	HEV2aN-P-DC9V
12V DC	HEV2aN-P-DC12V
15V DC	HEV2aN-P-DC15V
24V DC	HEV2aN-P-DC24V

Standard packing: Carton: 10 pcs.; Case: 50 pcs.

RATING

1. Coil data

- Operating characteristics such as 'Operate voltage' and 'Release voltage' are influenced by mounting conditions, ambient temperature, etc. Therefore, please use the relay within $\pm 5\%$ of rated coil voltage.
- 'Initial' means the condition of products at the time of delivery.

Nominal coil voltage	Pick-up voltage (at 20°C 68°F) (Initial)	Drop-out voltage (at 20°C 68°F) (Initial)	Nominal operating current [$\pm 10\%$] (at 20°C 68°F)	Coil resistance [$\pm 10\%$] (at 20°C 68°F)	Nominal operating power	Max. applied voltage (at 55°C 131°F)
6V DC	70%V or less of nominal voltage	5%V or more of nominal voltage	320mA	18.8Ω	1,920mW	110%V of nominal voltage
9V DC			213mA	42.2Ω		
12V DC			160mA	75.0Ω		
15V DC			128mA	117.0Ω		
24V DC			80mA	300.0Ω		

2. Specifications

Characteristics	Item	Specifications	
Contact	Arrangement	2 Form A	
	Contact material	AgNi type	
	Contact resistance (Initial)	Max. 100 mΩ (By voltage drop 6 V DC 1 A), Max. 3 mΩ (By voltage drop 6 V DC 20 A, Reference value)	
Rating	Contact rating (Resistive load)	20 A 800 VDC (at each 1 Form A contact connected in series), 20 A 400 VDC (at 1 Form A contact only)	
	Max. switching voltage	1,000 V DC	
	Max. switching current	20 A	
	Min. switching capacity (Reference value)*1	100 mA 5 V DC	
Electrical characteristics	Insulation resistance (Initial)	Min. 1,000MΩ (at 1,000V DC) Measurement at same location as "Breakdown voltage" section.	
	Short current (Initial)	Max. 300 A 1 ms (Reference value)	
	Breakdown voltage (Initial)	Between open contacts	2,000 Vrms for 1 min. (Detection current: 10 mA)
		Between contact sets	4,000 Vrms for 1 min. (Detection current: 10 mA)
		Between contact and coil	5,000 Vrms for 1 min. (Detection current: 10 mA)
	Surge breakdown voltage**2 (Between contact and coil) (Initial)	Min. 10,000 V	
	Coil temperature rise value	Max. 75°C 135°F (By resistive method, contact carrying current: 20A, 100%V of nominal coil voltage at 55°C 131°F.) Max. 45°C 113°F (By resistive method, contact carrying current: 20A, 60%V of nominal coil voltage at 85°C 185°F.)	
	Coil holding voltage*3	33 to 110%V (Contact carrying current: 20A, at 55°C 131°F), 33 to 60%V (Contact carrying current: 20A, at 85°C 185°F)	
	Operate time (at 20°C 68°F)	Max. 30 ms (nominal coil voltage, without bounce)	
	Release time (at 20°C 68°F)	Max. 10 ms (nominal coil voltage) (without diode)	
Mechanical characteristics	Shock resistance	Functional	Min. 98 m/s ² (Half-wave pulse of sine wave: 11 ms; detection time: 10 μs)
		Destructive	Min. 980 m/s ² (Half-wave pulse of sine wave: 6 ms)
	Vibration resistance	Functional	10 to 55 Hz at double amplitude of 1.0 mm (Detection time: 10 μs)
		Destructive	10 to 55 Hz at double amplitude of 1.5 mm
Expected life	Mechanical life	Min. 10 ⁶ (at 180 cpm)	
Conditions	Conditions for operation, transport and storage*4	Ambient temperature: -40 to +55°C -40 to +131°F (When coil holding voltage is 33% to 110% of nominal coil voltage) -40 to +85°C -40 to +185°F (When applied coil hold voltage is 33% to 60% of nominal coil voltage) Humidity: 5 to 85% R.H. (Not freezing and condensing)	
	Max. operating speed	6 times/min. (at nominal switching capacity ON : OFF = 1s : 9s)	
Unit weight		Approx. 120 g 4.23 oz	

Notes: *1. This value can change due to the switching frequency, environmental conditions, and desired reliability level, therefore it is recommended to check this with the actual load.

*2. Wave is standard shock voltage of $\pm 1.2 \times 50 \mu s$ according to JEC-212-1981

*3. Coil holding voltage is the coil voltage after 100 ms following application of the nominal coil voltage.

*4. The upper operation ambient temperature limit is the maximum temperature that can satisfy the coil temperature rise value. Refer to Usage, transport and storage conditions in NOTES.

3. Electric life

1. Each 1 Form A contact connected in series

Conditions: Ambient temperature: 20°C 68°F (L/R ≤ 1 ms) (ON : OFF = 1s : 9s)

Resistive load	20A 800V DC	Min. 1×10 ³ ope.
	20A 600V DC	Min. 1×10 ⁴ ope.
Overload	20A 1,000V DC	Min. 10 ope.
Reverse	-20A 400V DC	Min. 1×10 ³ ope.
Inrush current	40A 800V DC	Min. 1×10 ³ ope.

2. 1 Form A contact only

Conditions: Ambient temperature: 20°C 68°F (L/R ≤ 1 ms) (ON : OFF = 1s : 9s)

Resistive load	20A 400V DC	Min. 1×10 ³ ope.
	20A 300V DC	Min. 1×10 ⁴ ope.
Overload	20A 500V DC	Min. 10 ope.
Reverse	-20A 200V DC	Min. 1×10 ³ ope.
Inrush current	40A 400V DC	Min. 1×10 ³ ope.

Recommended circuit

Positive polarity of load should be connected to pin 1 and pin 3, refer to the following circuit schematics.

1. Each 1 Form A contact connected in series (Bottom view)

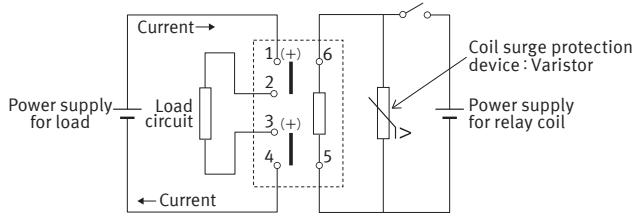

2. 1 Form A contact only (Bottom view)

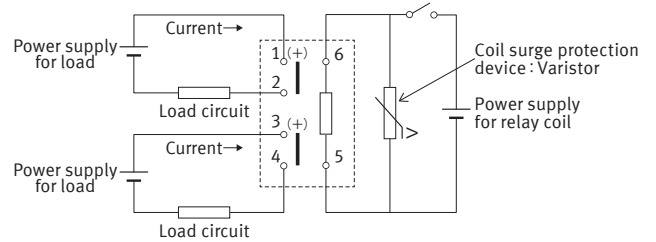

REFERENCE DATA

1. Maximum switching power

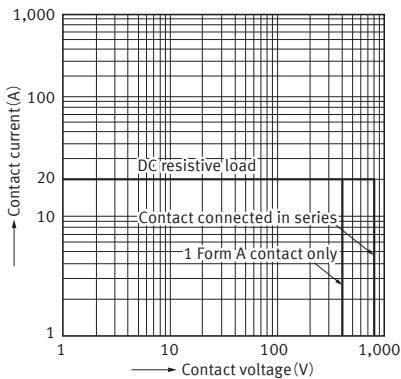

2. Ambient temperature characteristics

Tested sample : HEV2aN-P-12V DC, 6 pcs.

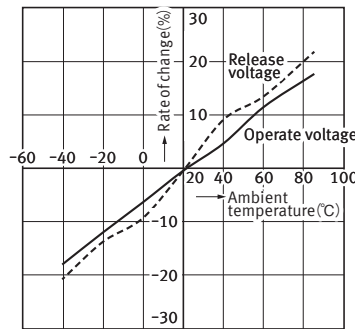

3. Coil temperature rise

Measured portion : Coil inside
Contact current : 20A
Ambient temperature : 25°C, 55°C, 85°C

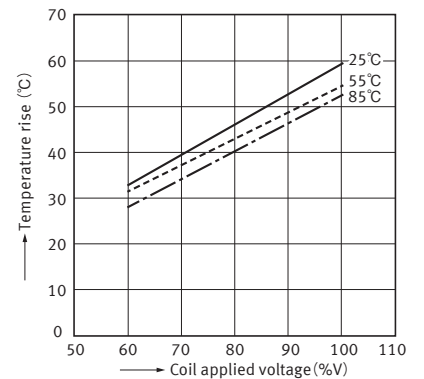

4.-(1) Cut-off life curve (forward direction)

[Contact connected in series]

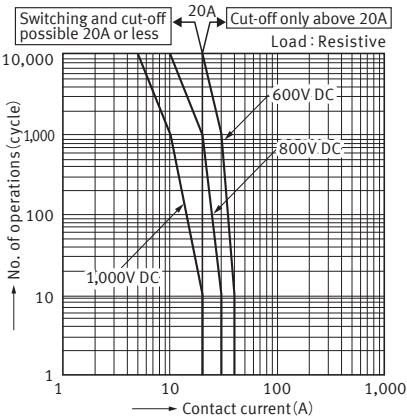

4.-(2) Cut-off life curve (forward direction)

[1 Form A contact only]

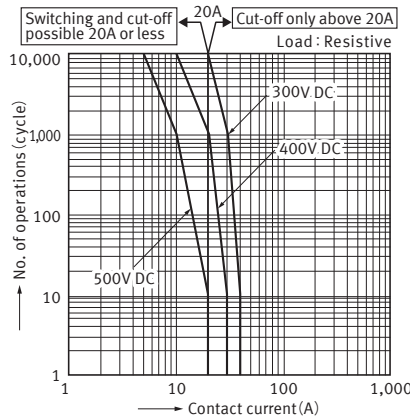

DIMENSIONS (mm)

CAD The CAD data of the products with a "CAD" mark can be downloaded from our Website.

CAD



External dimensions

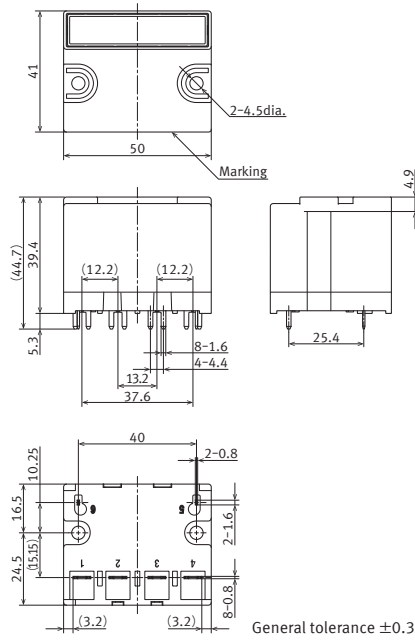

PC board pattern (Bottom view)

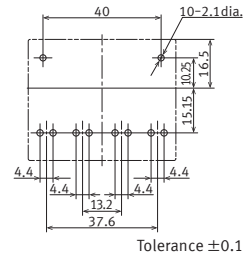

Schematic (Bottom view)

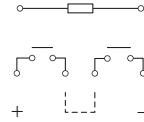

SAFETY STANDARDS

UL/C-UL (Recognized)		VDE (Certified)	
File No.	Contact rating	File No.	Contact rating
E43028	20A 600V DC 10,000 ope. (at 85°C 185°F, Same polarity only)	4000681	20A 600V DC 10,000 ope. (at 85°C 185°F) 20A 800V DC 1,000 ope. (at 85°C 185°F) 20A 1000V DC 10 ope. (at 85°C 185°F)

NOTES

- For cautions for use, please read "GENERAL APPLICATION GUIDELINES" on page B-1.
- Usage, transport and storage conditions

1) Temperature:
 -40 to +55°C -40 to +131°F (When coil holding voltage is 33 to 110%V)
 -40 to +85°C -40 to +185°F (When coil holding voltage is 33% to 60%V)
 2) Humidity: 5 to 85% RH
 (Avoid freezing and condensation.)
 The humidity range varies with the temperature. Use within the range indicated in the graph.

3) Atmospheric pressure: 86 to 106 kPa

Temperature and humidity range for usage, transport, and storage

(Coil holding voltage: 33 to 110%V)

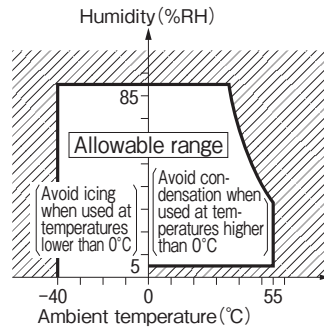

(Coil holding voltage: 33 to 60%V)

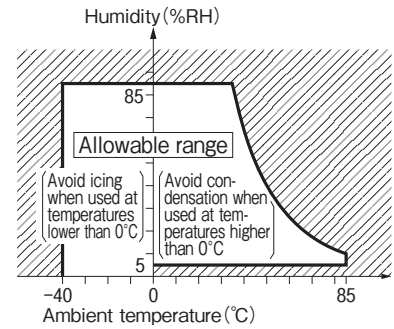

4) Condensation

Condensation forms when there is a sudden change in temperature under high temperature and high humidity conditions. Condensation will cause deterioration of the relay insulation.

5) Freezing

Condensation or other moisture may freeze on the relay when the temperature is lower than 0°C 32°F. This causes problems such as sticking of movable parts or operational time lags.

6) Low temperature, low humidity environments

The plastic becomes brittle if the relay is exposed to a low temperature, low humidity environment for long periods of time.

3. Solder and cleaning conditions

1) Please obey the following conditions when soldering automatically.

(1) Preheating: Max. 120°C 248°F (solder surface terminal portion) and within 120 seconds

(2) Soldering iron: 260°C±5°C 500°F±41°F (solder temperature) and within 10 seconds (soldering time)

2) Please obey the following conditions when manual soldering.

Max. 260°C 500°F (solder temperature) and within 10 seconds (soldering time)

Max. 350°C 662°F (solder temperature) and within 3 seconds (soldering time)

*Effects of soldering heat on the relays vary depending on the PC board. So please confirm actual soldering condition with the PC board used for assembling.

3) Since this is not a sealed type relay, do not clean it as is. Also, be careful not to allow flux to overflow above the PC board or enter the inside of the relay.

4. Certification

1) This relay is UL/C-UL certified.

20A 600VDC 10⁴ ope.

(at 85°C 185°F, Same polarity only)

2) This relay is certified by VDE

20A 600VDC 10⁴ ope.

(at 85°C 185°F)

20A 800VDC 10³ ope.

(at 85°C 185°F)

20A 1000VDC 10 ope.

(at 85°C 185°F)

5. Cautions for use

1) For precautions regarding use and explanations of technical terminology, please refer to our web site.

(<http://industrial.panasonic.com/ac/e/>)

2) To ensure good operation, please keep the voltage on the coil ends to ±5% (at 20°C 68°F) of the rated coil operation voltage. Also, please be aware that the pick-up voltage and drop-out voltage may change depending on the temperature and conditions of use.

3) Keep the ripple rate of the nominal coil voltage below 5%.

And do not have a parallel connection with diode for the purpose of coil surge absorber. Instead of diode, a Varistor is recommended for the absorber.

Recommended Varistor;

Maximum energy: more than 1J

Varistor voltage: 150 to 400% of nominal voltage

4) The cycle lifetime is defined under the standard test condition specified in the JIS C5442 standard (temperature 15 to 35°C 59 to 95°F, humidity 25 to 75%). Check this with the real device as it is affected by coil driving circuit, load type, activation frequency, ambient conditions and other factors.

Especially, contact terminals have polarity. So if the contact terminals were connected with opposite pole, the electric life would be shorter.

5) This value can change due to the switching frequency, environmental conditions, and desired reliability level, therefore it is recommended to check this with the actual load.

6) Heat, smoke, and even a fire may occur if the relay is used in conditions outside of the allowable ranges for the coil ratings, contact ratings, operating cycle lifetime, and other specifications. Therefore, do not use the relay if these ratings are exceeded.

7) If the relay has been dropped, the appearance and characteristics should always be checked before use.

8) Incorrect wiring may cause unexpected events or the generation of heat or flames.

9) The relay should not be installed near strong magnetic field (transformers, magnets, etc.) and should not be installed near objects that radiate heat.

10) If the several relays are mounted closely or a heat-generation object is close to the relay, take care to check the abnormal temperature-rise and the insulation distance between the terminals outside of the relay.

11) If you are using an inductive load (L load) such that $L/R > 1\text{ms}$, add surge protection in parallel with the inductive load. If this is not done, the electrical life will decrease and cut-off failure may occur.

12) In case using a capacitive load (Cload), please take a countermeasure as pre-charging to the capacitive load so that the inrush current will not surpass 40A. The relay might have a contact welding without such countermeasure.

13) This relay is a high-voltage directcurrent

switch. In its final breakdown mode, it may lose the ability to provide the proper cut-off. Therefore, do not exceed the indicated switching capacity and life. (Please treat the relay as a product with limited life and replace it when necessary.)

In the event that the relay loses cut-off ability, there is a possibility that burning may spread to surrounding parts, so configure the layout so that the power is turned off within one second and from the point of view of safety, consider installing a failsafe circuit in the device.

14) Please carry out the design which had a enough margin in conductor width and a space between conductors in the case of a design of a printed circuit board.

15) Contact terminals have polarity. So if the contact terminals were connected with opposite pole, the electric life would be shorter. There is no polarity if they are used for power distribution only.

Please refer to "the latest product specifications" when designing your product.

• Requests to customers :

<https://industrial.panasonic.com/ac/e/salespolicies/>

GUIDELINES FOR POWER RELAYS AND HIGH-CAPACITY DC CUT OFF RELAYS USAGE

For cautions for use, please read "GUIDELINES FOR RELAY USAGE".

https://industrial.panasonic.com/ac/e/control/relay/cautions_use/index.jsp

Precautions for Coil Input

■ Long term current carrying

A circuit that will be carrying a current continuously for long periods without relay switching operation. (circuits for emergency lamps, alarm devices and error inspection that, for example, revert only during malfunction and output warnings with form B contacts) Continuous, long-term current to the coil will facilitate deterioration of coil insulation and characteristics due to heating of the coil itself.

For circuits such as these, please use a magnetic-hold type latching relay. If you need to use a single stable relay, use a sealed type relay that is not easily affected by ambient conditions and make a failsafe circuit design that considers the possibility of contact failure or disconnection.

■ DC Coil operating power

Steady state DC current should be applied to the coil. The wave form should be rectangular. If it includes ripple, the ripple factor should be less than 5%.

However, please check with the actual circuit since the electrical characteristics may vary. The rated coil voltage should be applied to the coil and the set/reset pulse time of latching type relay differs for each relays, please refer to the relay's individual specifications.

■ Coil connection

When connecting coils of polarized relays, please check coil polarity (+,-) at the internal connection diagram (Schematic). If any wrong connection is made, it may cause unexpected malfunction, like abnormal heat, fire and so on, and circuit do not work. Avoid impressing voltages to the set coil and reset coil at the same time.

Ambient Environment

● Usage, Transport, and Storage Conditions

During usage, storage, or transportation, avoid locations subjected to direct sunlight and maintain normal temperature, humidity and pressure conditions.

● Temperature/Humidity/Pressure

When transporting or storing relays while they are tube packaged, there are cases the temperature may differ from the allowable range. In this case be sure to check the individual specifications. Also allowable humidity level is influenced by temperature, please check charts shown below and use relays within mentioned conditions. (Allowable temperature values differ for each relays, please refer to the relay's individual specifications.)

1) Temperature:

The tolerance temperature range differs for each relays, please refer to the relay's individual specifications

2) Humidity:

5 to 85 % RH

3) Pressure:

86 to 106 kPa

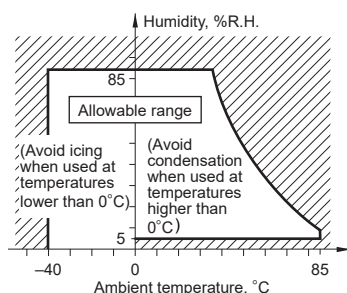

■ Maximum allowable voltage and temperature rise

Proper usage requires that the rated coil voltage be impressed on the coil. Note, however, that if a voltage greater than or equal to the maximum continuous voltage is impressed on the coil, the coil may burn or its layers short due to the temperature rise. Furthermore, do not exceed the usable ambient temperature range listed in the catalog.

■ Operate voltage change due to coil temperature rise (Hot start)

In DC relays, after continuous passage of current in the coil, if the current is turned OFF, then immediately turned ON again, due to the temperature rise in the coil, the pick-up voltage will become somewhat higher. Also, it will be the same as using it in a higher temperature atmosphere. The resistance/temperature relationship for copper wire is about 0.4% for 1°C, and with this ratio the coil resistance increases. That is, in order to operate of the relay, it is necessary that the voltage be higher than the pick-up voltage and the pick-up voltage rises in accordance with the increase in the resistance value. However, for some polarized relays, this rate of change is considerably smaller.

● Dew condensation

Condensation occurs when the ambient temperature drops suddenly from a high temperature and humidity, or the relay is suddenly transferred from a low ambient temperature to a high temperature and humidity. Condensation causes the failures like insulation deterioration, wire disconnection and rust etc. Panasonic Corporation does not guarantee the failures caused by condensation.

The heat conduction by the equipment may accelerate the cooling of device itself, and the condensation may occur.

Please conduct product evaluations in the worst condition of the actual usage. (Special attention should be paid when high temperature heating parts are close to the device. Also please consider the condensation may occur inside of the device.)

● Icing

Condensation or other moisture may freeze on relays when the temperature become lower than 0°C. This icing causes the sticking of movable portion, the operation delay and the contact conduction failure etc. Panasonic Corporation does not guarantee the failures caused by the icing.

The heat conduction by the equipment may accelerate the cooling of relay itself and the icing may occur. Please conduct product evaluations in the worst condition of the actual usage.

● Low temperature and low humidity

The plastic becomes brittle if the switch is exposed to a low temperature, low humidity environment for long periods of time.

● High temperature and high humidity

Storage for extended periods of time (including transportation periods) at high temperature or high humidity levels or in atmospheres with organic gases or sulfide gases may cause a sulfide film or oxide film to form on the surfaces of the contacts and/or it may interfere with the functions. Check out the atmosphere in which the units are to be stored and transported.

GUIDELINES FOR POWER RELAYS AND HIGH-CAPACITY DC CUT OFF RELAYS USAGE

●Package

In terms of the packing format used, make every effort to keep the effects of moisture, organic gases and sulfide gases to the absolute minimum.

●Silicon

When a source of silicone substances (silicone rubber, silicone oil, silicone coating materials and silicone filling materials etc.) is used around the relay, the silicone gas (low molecular siloxane etc.) may be produced.

This silicone gas may penetrate into the inside of the relay. When the relay is kept and used in this condition, silicone compound may adhere to the relay contacts which may cause the contact failure. Do not use any sources of silicone gas around the relay (Including plastic seal types).

●NOx Generation

When relay is used in an atmosphere high in humidity to switch a load which easily produces an arc, the NOx created by the arc and the water absorbed from outside the relay combine to produce nitric acid. This corrodes the internal metal parts and adversely affects operation. Avoid use at an ambient humidity of 85%RH or higher (at 20°C). If use at high humidity is unavoidable, please contact our sales representative.

Others

■Cleaning

- 1) Although the environmentally sealed type relay (plastic sealed type, etc.) can be cleaned, avoid immersing the relay into cold liquid (such as cleaning solvent) immediately after soldering. Doing so may deteriorate the sealing performance.
- 2) Cleaning with the boiling method is recommended(The temperature of cleaning liquid should be 40°C or lower).
Avoid ultrasonic cleaning on relays. Use of ultrasonic cleaning may cause breaks in the coil or slight sticking of the contacts due to ultrasonic energy.

Please refer to "**the latest product specifications**" when designing your product.

•Requests to customers:

<https://industrial.panasonic.com/ac/e/salespolicies/>

Please contact

Panasonic Corporation

Electromechanical Control Business Division

■ 1006, Oaza Kadoma, Kadoma-shi, Osaka 571-8506, Japan
industrial.panasonic.com/ac/e/

Panasonic®

©Panasonic Corporation 2019

单击下面可查看定价，库存，交付和生命周期等信息

[>>Panasonic\(松下\)](#)