

PJQ5946V-AU

40V Dual N-Channel Enhancement Mode MOSFET

Voltage	40 V	Current	57 A
----------------	-------------	----------------	-------------

Features

- $R_{DS(ON)}$, $V_{GS}@10V$, $I_D@10A < 7m\Omega$
- $R_{DS(ON)}$, $V_{GS}@7V$, $I_D@6A < 8.4m\Omega$
- Excellent FOM
- Standard Level Drive
- AEC-Q101 qualified
- Lead free in compliance with EU RoHS 2.0
- Green molding compound as per IEC 61249 standard

Mechanical Data

- Case : DFN5060B-8L Package
- Terminals : Solderable per MIL-STD-750, Method 2026
- Approx. Weight : 0.092 grams

DFN5060B-8L

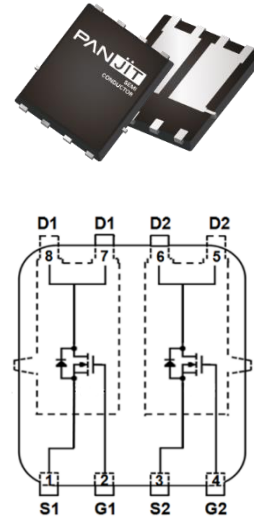

Maximum Ratings and Thermal Characteristics ($T_A=25^\circ C$ unless otherwise noted)

PARAMETER		SYMBOL	LIMIT	UNITS
Drain-Source Voltage		V_{DS}	40	V
Gate-Source Voltage		V_{GS}	± 20	
Continuous Drain Current ^(Note 3)	$T_C=25^\circ C$	I_D	57	A
	$T_C=100^\circ C$		41	
Pulsed Drain Current ^(Note 1)	$T_C=25^\circ C$	I_{DM}	228	
Power Dissipation	$T_C=25^\circ C$	P_D	42	W
	$T_C=100^\circ C$		21	
Continuous Drain Current ^(Note 4)	$T_A=25^\circ C$	I_D	14	A
	$T_A=70^\circ C$		12	
Power Dissipation	$T_A=25^\circ C$	P_D	2.5	W
	$T_A=70^\circ C$		1.8	
Single Pulse Avalanche Energy ^(Note 5)		E_{AS}	43	mJ
Operating Junction and Storage Temperature Range		T_J, T_{STG}	-55~175	$^\circ C$
Thermal Resistance ^(Note 4)	Junction to Case	$R_{\theta JC}$	3.6	$^\circ C/W$
	Junction to Ambient	$R_{\theta JA}$	60	

PJQ5946V-AU

Electrical Characteristics (T_A=25°C unless otherwise noted)

PARAMETER	SYMBOL	TEST CONDITION	MIN.	TYP.	MAX.	UNITS
Static						
Drain-Source Breakdown Voltage	BV _{DSS}	V _{GS} =0V, I _D =250uA	40	-	-	V
Gate Threshold Voltage	V _{GS(th)}	V _{DS} =V _{GS} , I _D =50uA	2	2.8	3.5	
Drain-Source On-State Resistance	R _{DS(on)}	V _{GS} =10V, I _D =10A	-	5.6	7	mΩ
		V _{GS} =7V, I _D =6A	-	6.5	8.4	
Zero Gate Voltage Drain Current	I _{DSS}	V _{DS} =40V, V _{GS} =0V	-	-	1	uA
Gate-Source Leakage Current	I _{GSS}	V _{GS} =±20V, V _{DS} =0V	-	-	±100	nA
Dynamic (Note 6)						
Total Gate Charge	Q _g	V _{DS} =32V, I _D =10A, V _{GS} =10V	-	23	31	nC
Gate-Source Charge	Q _{gs}		-	5	-	
Gate-Drain Charge	Q _{gd}		-	6	-	
Input Capacitance	C _{iss}	V _{DS} =25V, V _{GS} =0V, f=1MHz	-	1283	1668	pF
Output Capacitance	C _{oss}		-	252	378	
Reverse Transfer Capacitance	C _{rss}		-	46	80	
Gate resistance	R _g	f=1MHz	-	0.8	-	Ω
Turn-On Delay Time	t _{d(on)}	V _{DS} =32V, I _D =10A, V _{GS} =10V, R _G =3Ω (Note 2)	-	14	-	ns
Turn-On Rise Time	t _r		-	3	-	
Turn-Off Delay Time	t _{d(off)}		-	24	-	
Turn-Off Fall Time	t _f		-	5	-	
Drain-Source Diode						
Diode Forward Current	I _S	T _C =25°C	-	-	57	A
Pulsed Diode Forward Current	I _{SM}		-	-	228	
Diode Forward Voltage	V _{SD}	I _S =20A, V _{GS} =0V	-	0.86	1.3	V
Reverse Recovery Time	T _{rr}	V _{DD} =20V, V _{GS} =0V	-	24	-	ns
Reverse Recovery Charge	Q _{rr}	I _S =20A, dI _S /dt=100A/us	-	11	-	nC

NOTES :

1. Pulse width ≤ 100us, Duty cycle ≤ 2%.
2. Essentially independent of operating temperature typical characteristics.
3. Chip capability with an R_{θJC}=3.6°C/W.
4. R_{θJA} is the sum of the junction-to-case and case-to-ambient thermal resistance where the case thermal reference is defined as the solder mounting surface of the drain pins. Mounted on a 1 inch² with 2oz. square pad of copper.
5. The test condition is L=0.5mH, I_{AS}=13A, V_{DD}=30V, V_{GS}=10V, Starting T_J=25°C. the chip is about to carry I_{AS}=26A.
6. Guaranteed by design, not subject to production testing.

PJQ5946V-AU

TYPICAL CHARACTERISTIC CURVES

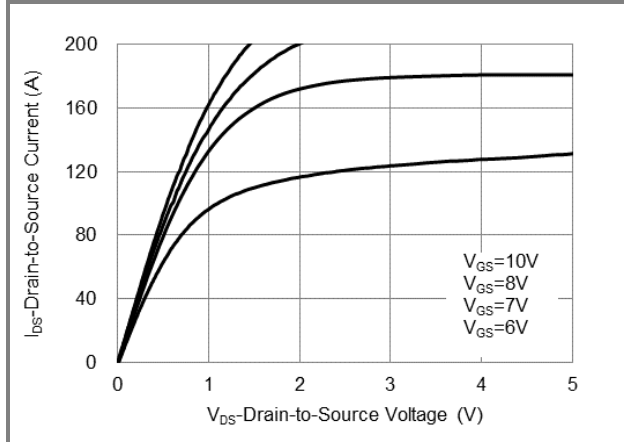

Fig.1 On-Region Characteristics

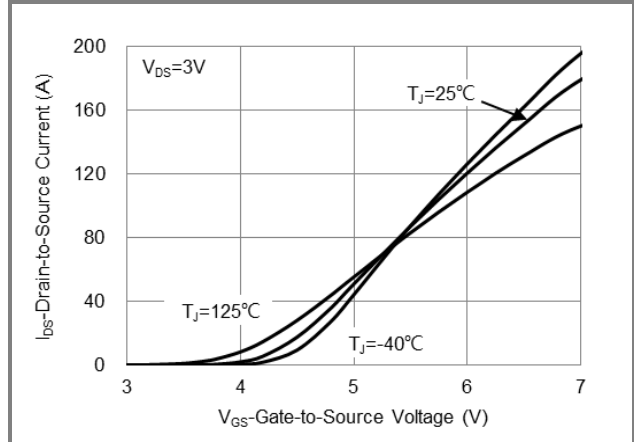

Fig.2 Transfer Characteristics

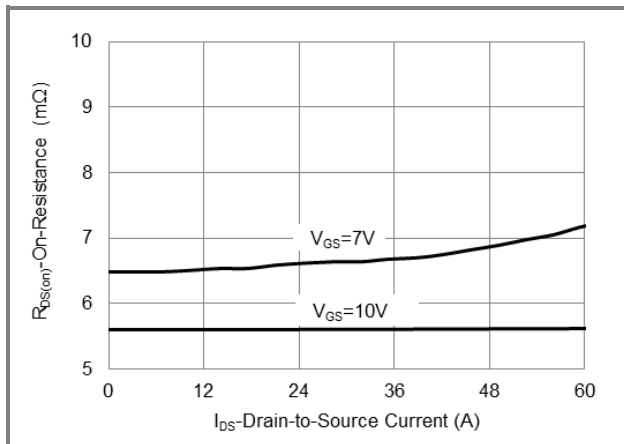

Fig.3 On-Resistance vs. Drain Current

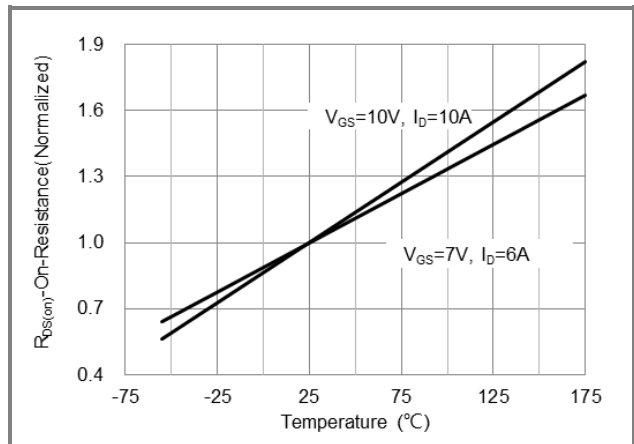

Fig.4 On-Resistance vs. Junction temperature

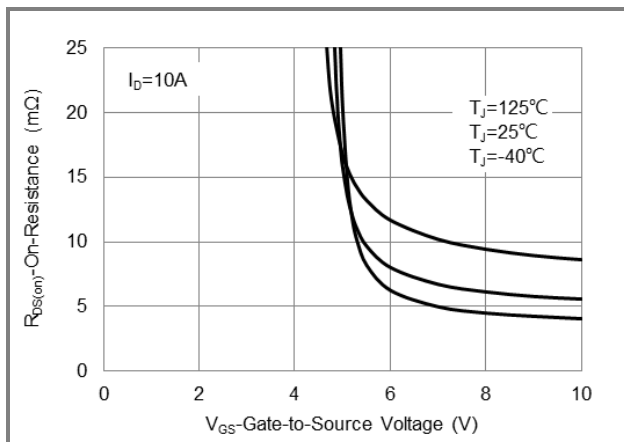

Fig.5 On-Resistance Variation with V_{GS}

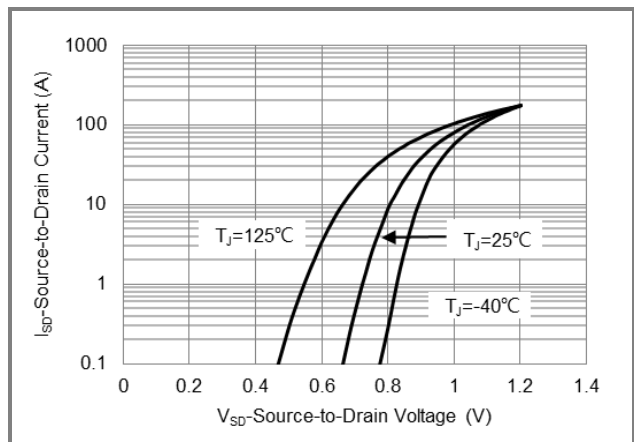

Fig.6 Source-Drain Diode Forward Voltage

PJQ5946V-AU

TYPICAL CHARACTERISTIC CURVES

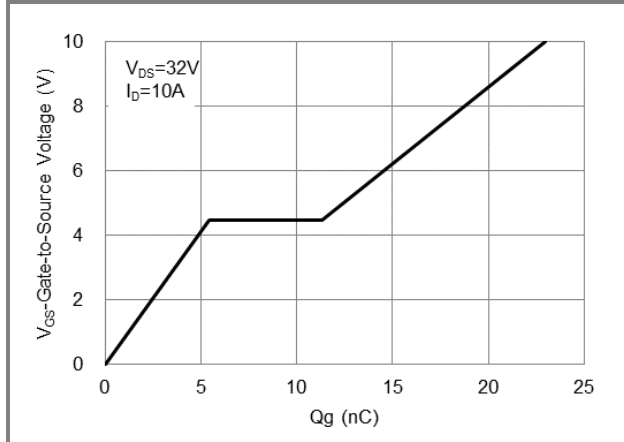

Fig.7 Gate-Charge Characteristics

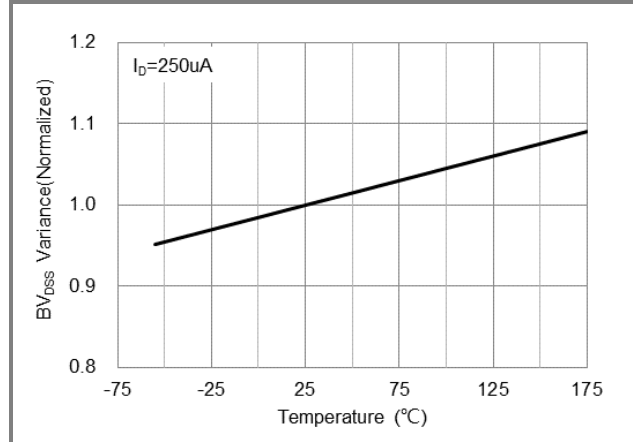

Fig.8 Breakdown Voltage Variation vs. Temperature

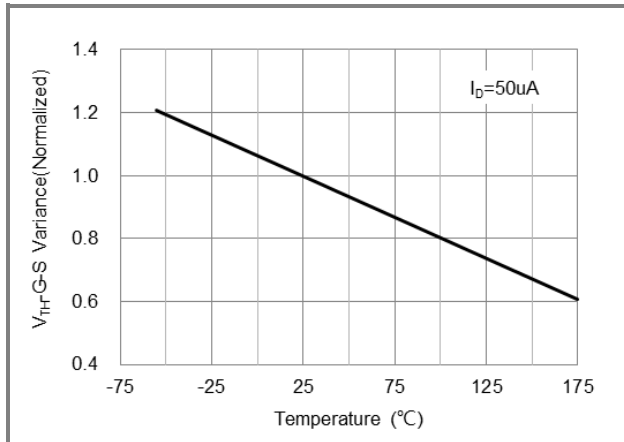

Fig.9 Threshold Voltage Variation with Temperature

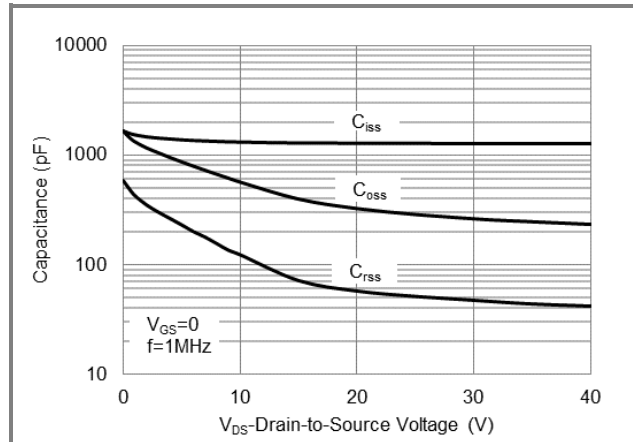

Fig.10 Capacitance vs. Drain-Source Voltage

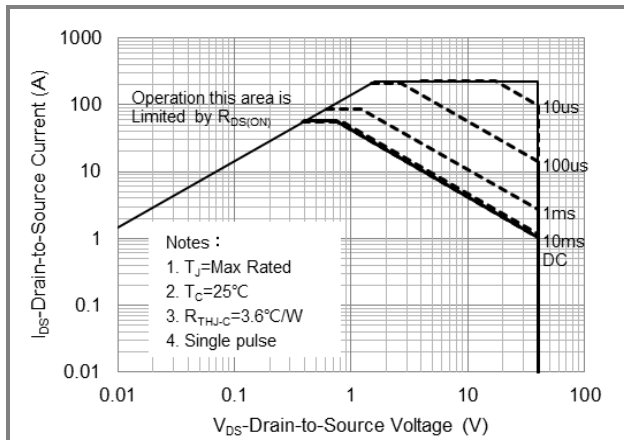

Fig.11 Maximum Safe Operating Area

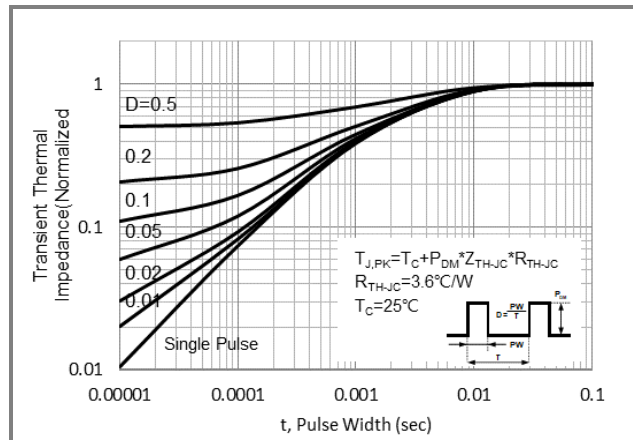

Fig.12 Normalized Transient Thermal Impedance

PJQ5946V-AU

Product and Packing Information

Part No.	Package Type	Packing Type	Marking
PJQ5946V-AU	DFN5060B-8L	3K pcs / 13" reel	Q5946V

Packaging Information & Mounting Pad Layout

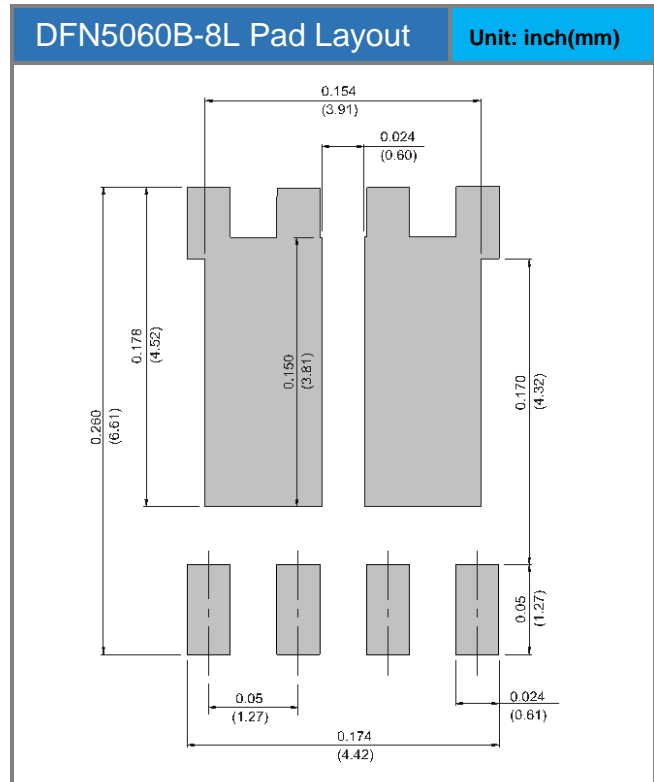
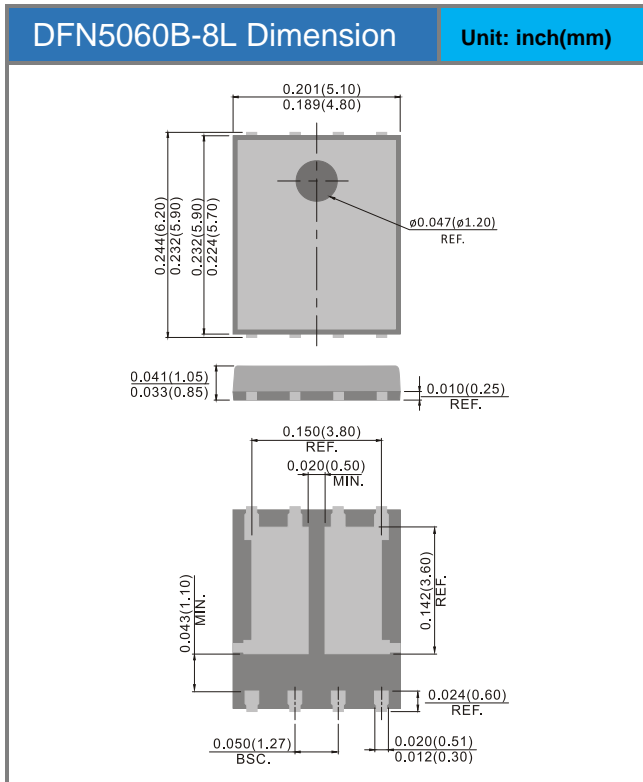

PJQ5946V-AU

Disclaimer

- Reproducing and modifying information of the document is prohibited without permission from Panjit International Inc..
- Panjit International Inc. reserves the rights to make changes of the content herein the document anytime without notification. Please refer to our website for the latest document.
- Panjit International Inc. disclaims any and all liability arising out of the application or use of any product including damages incidentally and consequentially occurred.
- Panjit International Inc. does not assume any and all implied warranties, including warranties of fitness for particular purpose, non-infringement and merchantability.
- Applications shown on the herein document are examples of standard use and operation. Customers are responsible in comprehending the suitable use in particular applications. Panjit International Inc. makes no representation or warranty that such applications will be suitable for the specified use without further testing or modification.
- The products shown herein are not designed and authorized for equipments relating to human life and for any applications concerning life-saving or life-sustaining, such as medical instruments, aerospace machinery et cetera. Customers using or selling these products for use in such applications do so at their own risk and agree to fully indemnify Panjit International Inc. for any damages resulting from such improper use or sale.
- Since Panjit uses lot number as the tracking base, please provide the lot number for tracking when complaining.

单击下面可查看定价，库存，交付和生命周期等信息

[>>Panjit\(强茂\)](#)