



S2GGF SERIES

SURFACE MOUNT RECTIFIER

VOLTAGE 400~1000 Volt **CURRENT** 2 Ampere

SMBF Unit : inch(mm)

FEATURES

- Plastic package has Underwriters Laboratory Flammability Classification 94V-O
- Easy pick and place
- Glass passivated junction
- Ultra Thin Profile Package for Space Constrained Utilization
- Package suitable for Automated Handling
- Lead free in compliance with EU RoHS 2011/65/EU directive.
- Green molding compound as per IEC61249 Std. . (Halogen Free)

MECHANICAL DATA

- Case : SMBF molded plastic
- Terminals : Solder plated, solderable per MIL-STD-750, Method 2026
- Approx. Weight : 0.0018 ounces, 0.05 grams
- Polarity : Color band denotes cathode end

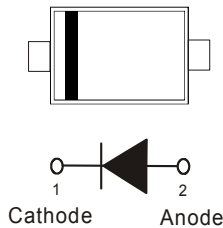

MAXIMUM RATINGS AND ELECTRICAL CHARACTERISTICS (T_A=25°C unless otherwise noted)

PARAMETER	SYMBOL	S2GGF	S2JGF	S2KGF	S2MGF	UNITS
Recurrent Peak Reverse Voltage	V _{RRM}	400	600	800	1000	V
RMS Voltage	V _{RMS}	280	420	560	700	V
DC Blocking Voltage	V _R	400	600	800	1000	V
Average Forward Current	I _{F(AV)}	2				A
Peak Forward Surge Current : 8.3ms single half sine-wave superimposed on rated load	I _{FSM}	70				A
Forward Voltage at 2A	V _F	1.1				V
DC Reverse Current at Rated DC Blocking Voltage	I _R	1				μA
Typical Junction Capacitance	C _J	18				pF
Typical Thermal Resistance ,Junction to Lead (Note 1) Junction to Ambient (Note 2)	R _{θJL} R _{θJA}	20 135				°C / W
Operating Junction Temperature and Storage Temperature Range	T _J , T _{STG}	-55 to +150				°C

NOTES:1.Mounted on an FR4 PCB, single-sided copper, with 100cm² copper pad area.
2.Mounted on an FR4 PCB, single-sided copper, mini pad.



S2GGF SERIES

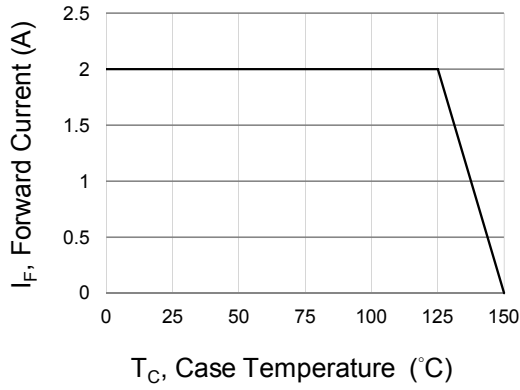

Fig.1 Forward Current Derating Curve

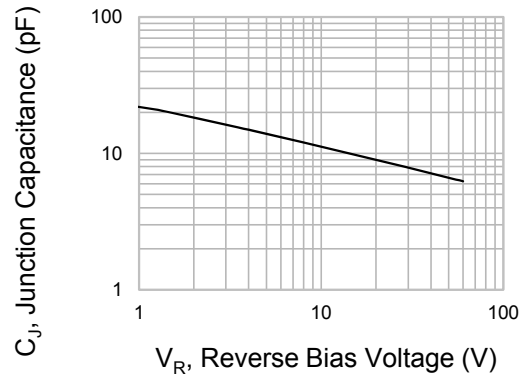

Fig.2 Typical Junction Capacitance

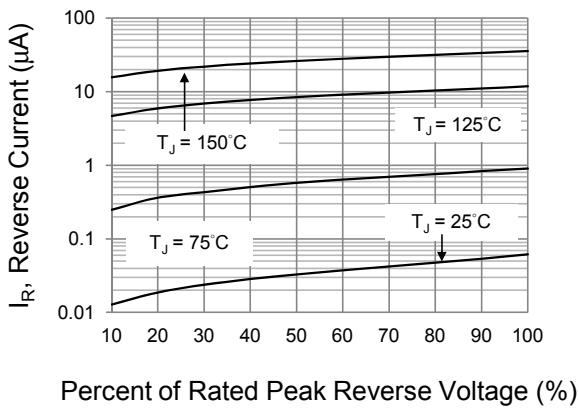

Fig.3 Typical Reverse Characteristics

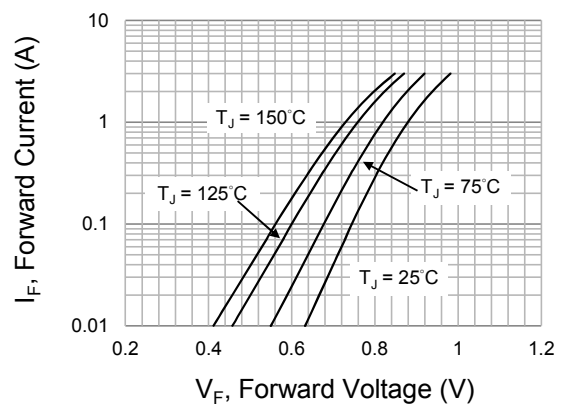
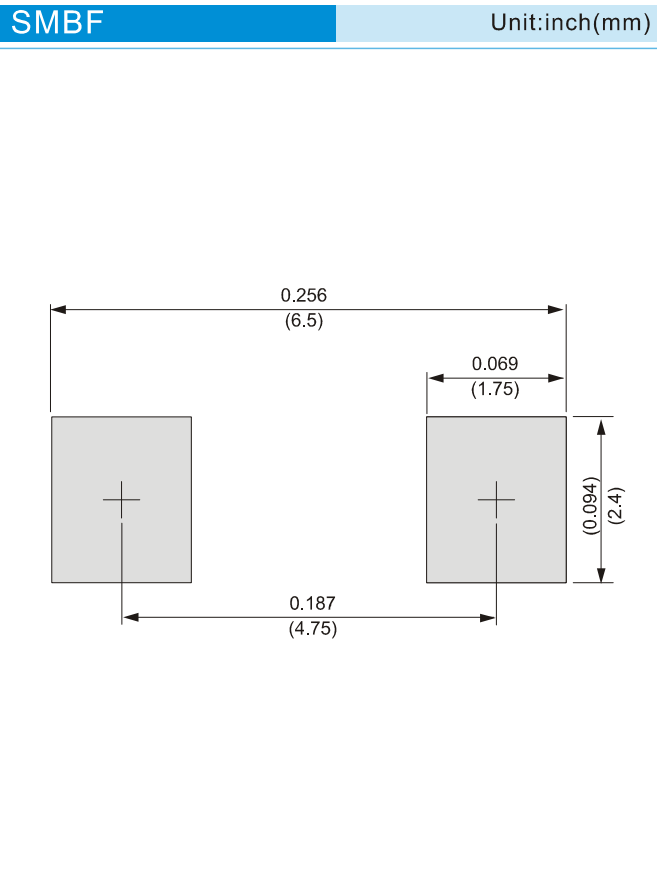

Fig.4 Typical Forward Characteristics



S2GGF SERIES

MOUNTING PAD LAYOUT



ORDER INFORMATION

- Packing information
T/R - 5K per 13" plastic Reel



S2GGF SERIES

Part No_packing code_Version

S2GGF_R2_00001

For example :

RB500V-40 **R2** **00001**

Part No.

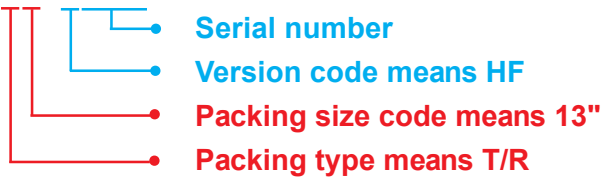

Packing Code XX				Version Code XXXXX		
Packing type	1 st Code	Packing size code	2 nd Code	HF or RoHS	1 st Code	2 nd ~5 th Code
Tape and Ammunition Box (T/B)	A	N/A	0	HF	0	serial number
Tape and Reel (T/R)	R	7"	1	RoHS	1	serial number
Bulk Packing (B/P)	B	13"	2			
Tube Packing (T/P)	T	26mm	X			
Tape and Reel (Right Oriented) (TRR)	S	52mm	Y			
Tape and Reel (Left Oriented) (TRL)	L	PANASERT T/B CATHODE UP (PBCU)	U			
FORMING	F	PANASERT T/B CATHODE DOWN (PBCD)	D			



S2GGF SERIES

Disclaimer

- Reproducing and modifying information of the document is prohibited without permission from Panjit International Inc..
- Panjit International Inc. reserves the rights to make changes of the content herein the document anytime without notification. Please refer to our website for the latest document.
- Panjit International Inc. disclaims any and all liability arising out of the application or use of any product including damages incidentally and consequentially occurred.
- Panjit International Inc. does not assume any and all implied warranties, including warranties of fitness for particular purpose, non-infringement and merchantability.
- Applications shown on the herein document are examples of standard use and operation. Customers are responsible in comprehending the suitable use in particular applications. Panjit International Inc. makes no representation or warranty that such applications will be suitable for the specified use without further testing or modification.
- The products shown herein are not designed and authorized for equipments requiring high level of reliability or relating to human life and for any applications concerning life-saving or life-sustaining, such as medical instruments, transportation equipment, aerospace machinery et cetera. Customers using or selling these products for use in such applications do so at their own risk and agree to fully indemnify Panjit International Inc. for any damages resulting from such improper use or sale.
- Since Panjit uses lot number as the tracking base, please provide the lot number for tracking when complaining.

单击下面可查看定价，库存，交付和生命周期等信息

[>>Panjit\(强茂\)](#)