



# SBM3060VDC

## ULTRA LOW VF SCHOTTKY RECTIFIER

**VOLTAGE** 60 Volt **CURRENT** 30 Ampere

### FEATURES

- Ultra low forward voltage drop, low power loss
- High efficiency operation
- Lead free in compliance with EU RoHS 2.0
- Green molding compound as per IEC 61249 standard

### MECHANICAL DATA

Case : TO-263/D<sup>2</sup>PAK, Plastic

Terminals : Solderable per MIL-STD-750, Method 2026

Weight: 0.049 ounces, 1.38 grams

**TO-263 / D<sup>2</sup>PAK** Unit : inch(mm)

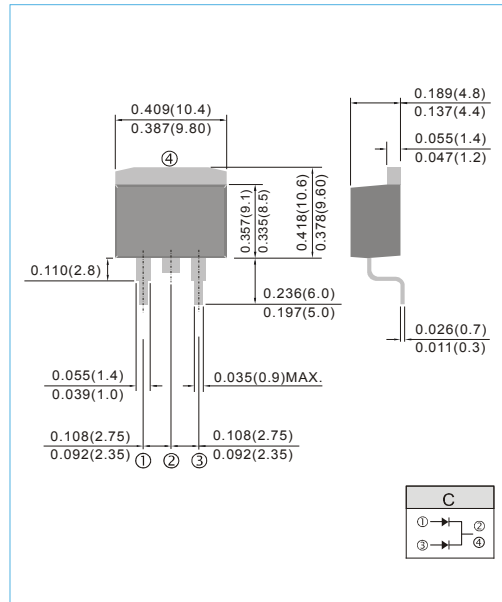

### MAXIMUM RATINGS(T<sub>A</sub>=25°C unless otherwise noted)

PARAMETER	SYMBOL	VALUE	UNIT
Maximum repetitive peak reverse voltage	V <sub>RRM</sub>	60	V
Maximum average forward rectified current	I <sub>F(AV)</sub>	15 30	A
Peak forward surge current 8.3ms single half sine-wave superimposed on rated load	I <sub>FSM</sub>	250	A
Typical junction capacitance (V <sub>R</sub> =4V, f=1MHz)	C <sub>J</sub>	650	pF
Typical thermal resistance per diode	R <sub>θJC</sub>	3.5	°C/W
Operating junction temperature range	T <sub>J</sub>	-55 to + 150	°C
Storage temperature range	T <sub>STG</sub>	-55 to + 150	°C

Note : 1. Mounted on infinite heatsink.

### ELECTRICAL CHARACTERISTICS(T<sub>A</sub>=25°C unless otherwise noted)

PARAMETER	SYMBOL	TEST CONDITIONS	MIN.	TYP.	MAX.	UNIT
Breakdown voltage per diode	V <sub>BR</sub>	I <sub>R</sub> =0.5mA	60	-	-	V
Instantaneous forward voltage per diode	V <sub>F</sub>	I <sub>F</sub> =3A	-	0.36	-	V
		I <sub>F</sub> =5A	-	0.40	-	V
		I <sub>F</sub> =15A	-	0.55	0.59	V
		I <sub>F</sub> =3A	-	0.29	-	V
Reverse current per diode	I <sub>R</sub>	V <sub>R</sub> =42V	-	30	-	μA
		V <sub>R</sub> =60V	-	-	220	μA
		V <sub>R</sub> =60V	-	16	-	mA



# SBM3060VDC

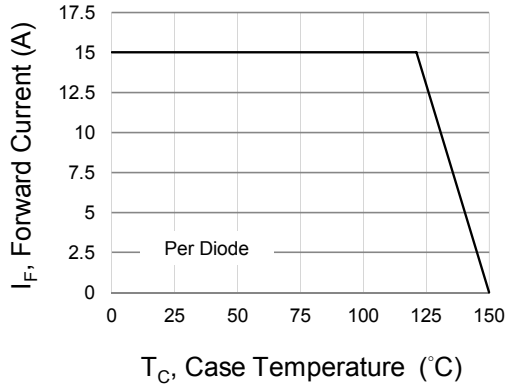

**Fig.1 Forward Current Derating Curve**

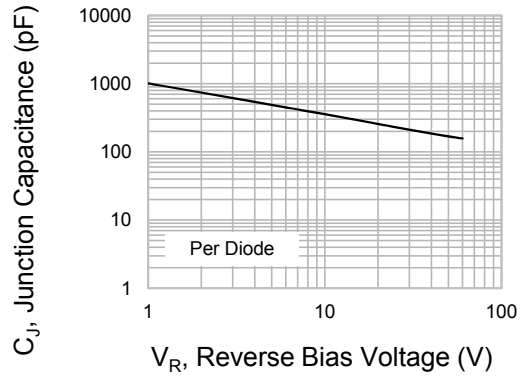

**Fig.2 Typical Junction Capacitance**

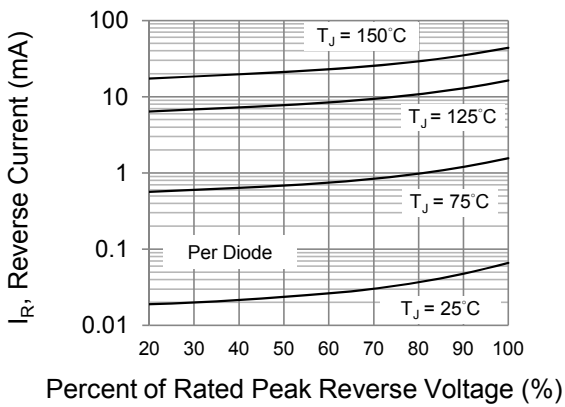

**Fig.3 Typical Reverse Characteristics**

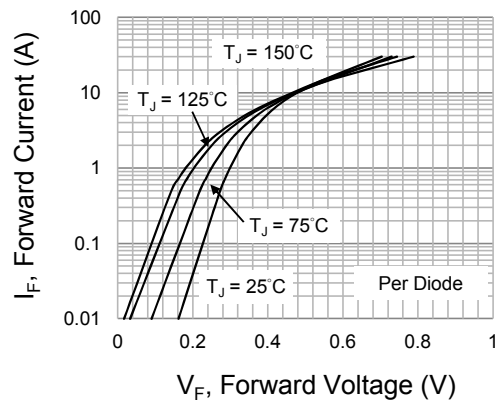

**Fig.4 Typical Forward Characteristics**



# SBM3060VDC

## MOUNTING PAD LAYOUT

TO-263 / D<sup>2</sup>PAK Unit : inch(mm)

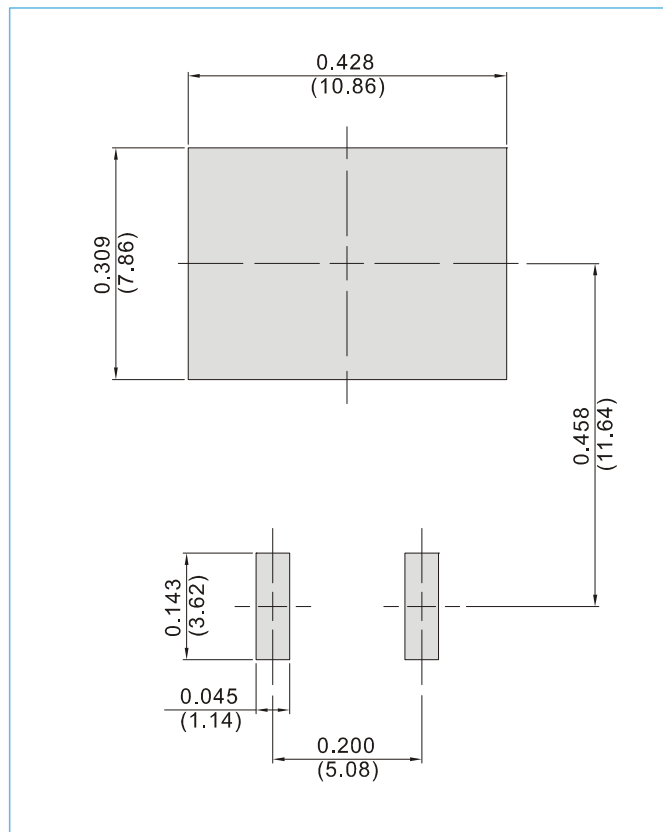

## ORDER INFORMATION

- Packing information  
T/R - 0.8K per 13" plastic Reel



# SBM3060VDC

Part No\_packing code\_Version

SBM3060VDC\_R2\_00001

For example :

RB500V-40\_R2\_00001

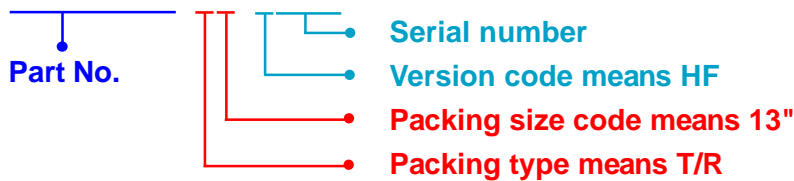

Packing Code <b>XX</b>				Version Code <b>XXXXX</b>		
Packing type	1 <sup>st</sup> Code	Packing size code	2 <sup>nd</sup> Code	HF or RoHS	1 <sup>st</sup> Code	2 <sup>nd</sup> ~5 <sup>th</sup> Code
Tape and Ammunition Box (T/B)	A	N/A	0	HF	0	serial number
Tape and Reel (T/R)	R	7"	1	RoHS	1	serial number
Bulk Packing (B/P)	B	13"	2			
Tube Packing (T/P)	T	26mm	X			
Tape and Reel (Right Oriented) (TRR)	S	52mm	Y			
Tape and Reel (Left Oriented) (TRL)	L	PANASERT T/B CATHODE UP (PBCU)	U			
FORMING	F	PANASERT T/B CATHODE DOWN (PBCD)	D			



## SBM3060VDC

---

### Disclaimer

- Reproducing and modifying information of the document is prohibited without permission from Panjit International Inc..
- Panjit International Inc. reserves the rights to make changes of the content herein the document anytime without notification. Please refer to our website for the latest document.
- Panjit International Inc. disclaims any and all liability arising out of the application or use of any product including damages incidentally and consequentially occurred.
- Panjit International Inc. does not assume any and all implied warranties, including warranties of fitness for particular purpose, non-infringement and merchantability.
- Applications shown on the herein document are examples of standard use and operation. Customers are responsible in comprehending the suitable use in particular applications. Panjit International Inc. makes no representation or warranty that such applications will be suitable for the specified use without further testing or modification.
- The products shown herein are not designed and authorized for equipments requiring high level of reliability or relating to human life and for any applications concerning life-saving or life-sustaining, such as medical instruments, transportation equipment, aerospace machinery et cetera. Customers using or selling these products for use in such applications do so at their own risk and agree to fully indemnify Panjit International Inc. for any damages resulting from such improper use or sale.
- Since Panjit uses lot number as the tracking base, please provide the lot number for tracking when complaining.

单击下面可查看定价，库存，交付和生命周期等信息

[>>Panjit\(强茂\)](#)