



P6AFC3.3A-AU ~ P6AFC64A-AU Series

Transient Voltage Suppressor

Voltage 3.3~64 V **Power** 600 W

Features

- Small plastic package suitable for surface-mounted design
- Very low package height: 1 mm
- Excellent clamping capability
- Ultra low reverse current
- High temperature soldering : 260°C/10 seconds at terminals
- AEC-Q101 qualified
- Lead free in compliance with EU RoHS 2.0
- Green molding compound as per IEC 61249 standard

Mechanical Data

- Case : Molded plastic, SMAF-C
- Terminals : Solder plated, solderable per MIL-STD-750, Method 2026
- Approx. Weight : 0.0012 ounces, 0.034 grams

SMAF-C

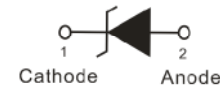
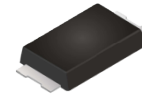

Maximum Ratings and Thermal Characteristics (T_A = 25 °C unless otherwise noted)

PARAMETER	SYMBOL	LIMIT	UNITS
Peak Pulse Power Dissipation(tp=10/1000us) ^(Note 1,2)	P _{PP}	600	W
Peak Forward Surge Current (8.3ms single half sine-wave)	I _{FSM}	100	A
Peak Pulse Current on tp=10/1000us Waveform ^(Note1, Fig.2)	I _{PPM}	See next table	A
Power Dissipation on Infinite Heat Sink at T _L = 50 °C	P _D	5	W
ESD IEC61000-4-2(Air)	V _{ESD}	±30	kV
ESD IEC61000-4-2(Contact)		±30	
Typical Thermal Resistance Junction to Ambient ^(Note 3)	R _{θJA}	150	°C/W
Operating Junction Temperature Range	T _J	-55 to +150	°C
Storage Temperature Range	T _{STG}	-55 to +150	°C

Notes : 1. Non-repetitive current pulse, per Fig.3 and derated above T_A=25°C per Fig.2

2. Mounted on 5.0x5.0mm copper pads to each terminal.

3. Mounted on a FR4 PCB, single-sided copper, standard footprint.

4. A transient suppressor is selected according to the working peak reverse voltage(V_{RWM}), which should be equal to or greater than the DC or continuous peak operation voltage level.

5. TVS is a transient protection device, it is strongly recommended not to use as a Zener.



P6AFC3.3A-AU ~ P6AFC64A-AU Series

Electrical Characteristics ($T_A = 25^\circ\text{C}$ unless otherwise noted)

Part Number	V_{RWM} (Note 4)	V_{BR}			$I_R@V_{RWM}$	$V_C@I_{PP}$		Marking Code
		Min.	Max.	I_T		Max.		
	V	V	V	mA	μA	V	A	
P6AFC3.3A-AU	3.3	5.2	6	10	100	8	75	6E3V3
P6AFC5.0A-AU	5	6.4	7	10	50	9.2	65.2	6E5V0
P6AFC6.0A-AU	6	6.67	7.37	10	50	10.3	58.3	6E6V0
P6AFC6.5A-AU	6.5	7.22	7.98	10	40	11.2	53.6	6E6V5
P6AFC7.0A-AU	7	7.78	8.6	10	40	12	50	6E7V0
P6AFC7.5A-AU	7.5	8.33	9.21	1	30	12.9	46.5	6E7V5
P6AFC8.0A-AU	8	8.89	9.83	1	5	13.6	44.1	6E8V0
P6AFC8.5A-AU	8.5	9.44	10.4	1	5	14.4	41.7	6E8V5
P6AFC9.0A-AU	9	10	11.1	1	0.5	15.4	39	6E9V0
P6AFC10A-AU	10	11.1	12.3	1	0.5	17	35.3	6E10
P6AFC11A-AU	11	12.2	13.5	1	0.5	18.2	33	6E11
P6AFC12A-AU	12	13.3	14.7	1	0.5	19.9	30.2	6E12
P6AFC13A-AU	13	14.4	15.9	1	0.1	21.5	27.9	6E13
P6AFC14A-AU	14	15.6	17.2	1	0.1	23.2	25.9	6E14
P6AFC15A-AU	15	16.7	18.5	1	0.1	24.4	24.6	6E15
P6AFC16A-AU	16	17.8	19.7	1	0.1	26	23.1	6E16
P6AFC17A-AU	17	18.9	20.9	1	0.1	27.6	21.7	6E17
P6AFC18A-AU	18	20	22.1	1	0.1	29.2	20.5	6E18
P6AFC20A-AU	20	22.2	24.5	1	0.1	32.4	18.5	6E20
P6AFC22A-AU	22	24.4	26.9	1	0.1	35.5	16.9	6E22
P6AFC24A-AU	24	26.7	29.5	1	0.1	38.9	15.4	6E24
P6AFC26A-AU	26	28.9	31.9	1	0.1	42.1	14.3	6E26
P6AFC28A-AU	28	31.1	34.4	1	0.1	45.4	13.2	6E28
P6AFC30A-AU	30	33.3	36.8	1	0.1	48.4	12.4	6E30
P6AFC33A-AU	33	36.7	40.6	1	0.1	53.3	11.3	6E33
P6AFC36A-AU	36	40	44.2	1	0.1	58.1	10.3	6E36
P6AFC40A-AU	40	44.4	49.1	1	0.1	64.5	9.3	6E40
P6AFC43A-AU	43	47.8	52.8	1	0.1	69.4	8.6	6E43
P6AFC45A-AU	45	50	55.3	1	0.1	72.7	8.3	6E45
P6AFC48A-AU	48	53.3	58.9	1	0.1	77.4	7.8	6E48
P6AFC51A-AU	51	56.7	62.7	1	0.1	82.4	7.3	6E51
P6AFC54A-AU	54	60	66.3	1	0.1	87.1	6.9	6E54
P6AFC58A-AU	58	64.4	71.2	1	0.1	93.6	6.4	6E58
P6AFC60A-AU	60	66.7	73.7	1	0.1	96.8	6.2	6E60
P6AFC64A-AU	64	71.1	78.6	1	0.1	103	5.8	6E64



P6AFC3.3A-AU ~ P6AFC64A-AU Series

TYPICAL CHARACTERISTIC CURVES

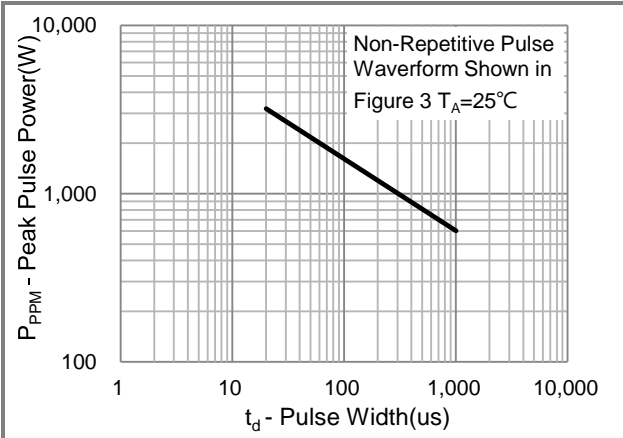

Fig.1 Pulse Power Rating Curve

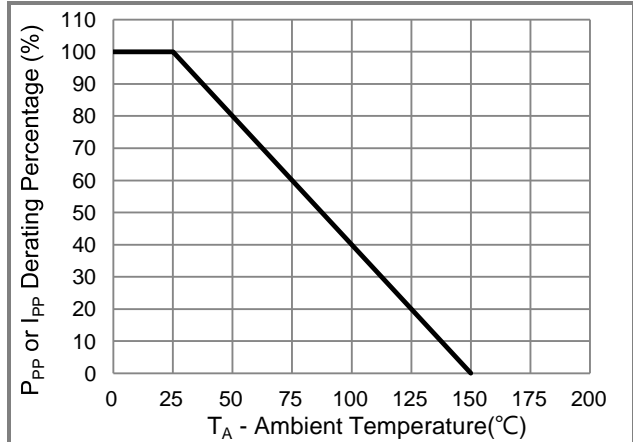

Fig.2 Derating Curve

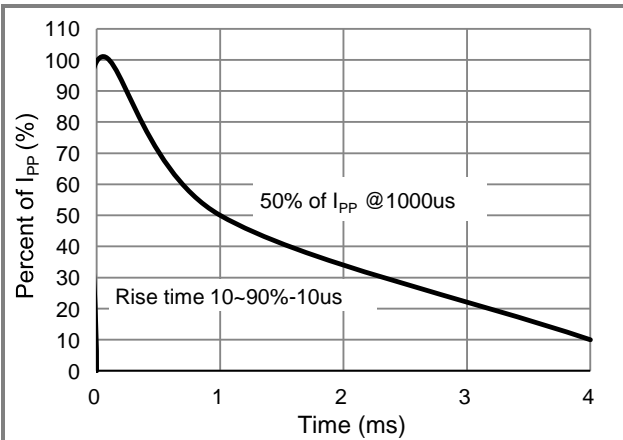

Fig.3 10/1000us Pulse Waveform

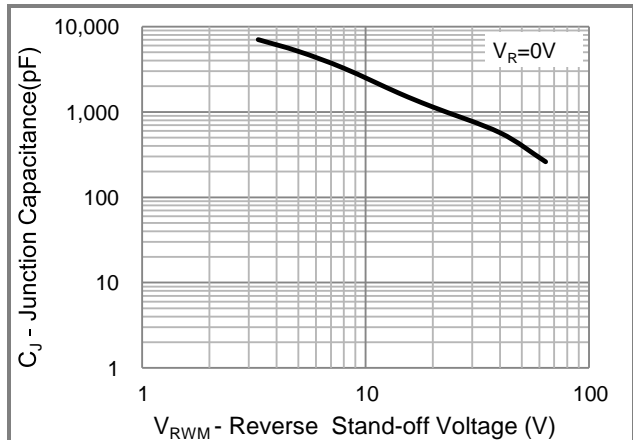

Fig.4 Typical Capacitance



P6AFC3.3A-AU ~ P6AFC64A-AU Series

Part No. Packing Code Version

Part No. Packing Code	Package Type	Packing Type	Marking	Version
P6AFCxxxA-AU_R1_000A1	SMAF-C	3K pcs / 7" reel	See Table	Halogen free

Packaging Information & Mounting Pad Layout

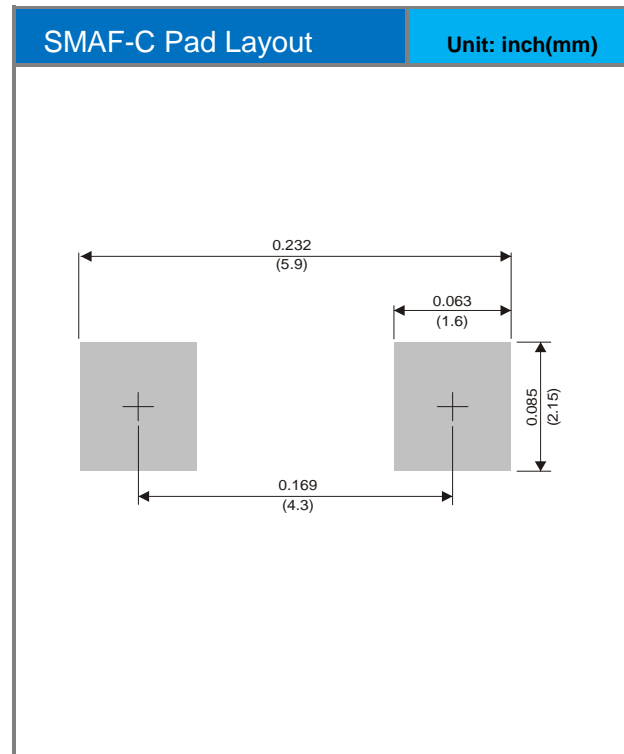
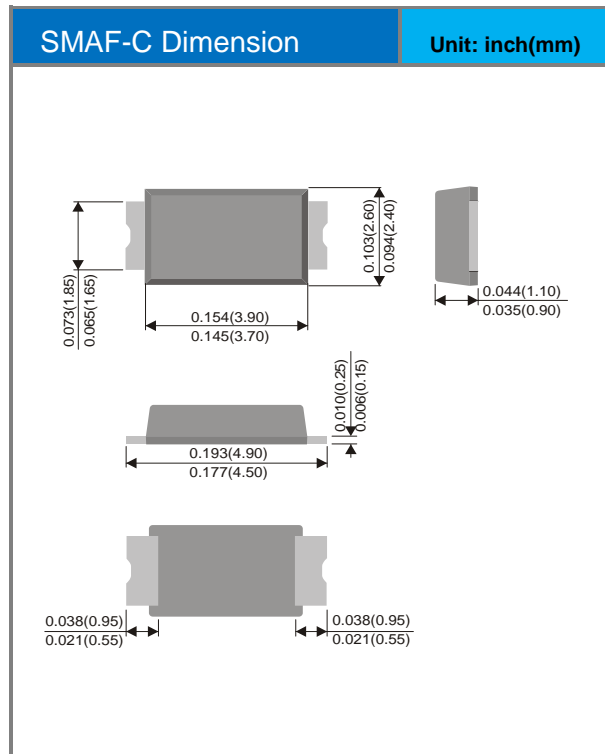



P6AFC3.3A-AU ~ P6AFC64A-AU Series

Disclaimer

- Reproducing and modifying information of the document is prohibited without permission from Panjit International Inc..
- Panjit International Inc. reserves the rights to make changes of the content herein the document anytime without notification. Please refer to our website for the latest document.
- Panjit International Inc. disclaims any and all liability arising out of the application or use of any product including damages incidentally and consequentially occurred.
- Panjit International Inc. does not assume any and all implied warranties, including warranties of fitness for particular purpose, non-infringement and merchantability.
- Applications shown on the herein document are examples of standard use and operation. Customers are responsible in comprehending the suitable use in particular applications. Panjit International Inc. makes no representation or warranty that such applications will be suitable for the specified use without further testing or modification.
- The products shown herein are not designed and authorized for equipments relating to human life and for any applications concerning life-saving or life-sustaining, such as medical instruments, aerospace machinery et cetera. Customers using or selling these products for use in such applications do so at their own risk and agree to fully indemnify Panjit International Inc. for any damages resulting from such improper use or sale.
- Since Panjit uses lot number as the tracking base, please provide the lot number for tracking when complaining.

单击下面可查看定价，库存，交付和生命周期等信息

[>>Panjit\(强茂\)](#)