



ES1JF-LE

SURFACE MOUNT SUPERFAST RECTIFIER

Voltage

600 V

Current

1 A

Features

- For surface mounted applications in order to optimize board space
- Easy pick and place
- Plastic package has Underwriters Laboratory Flammability Classification 94V-O
- Superfast recovery times for high efficiency
- Glass Passivated Chip Junction
- Ultra Thin Profile Package for Space Constrained Utilization
- Package suitable for automated handling
- Lead free in compliance with EU RoHS 2011/65/EU directive.
- Green molding compound as per IEC61249 Std..(Halogen Free)

Mechanical Data

- Case: Molded plastic, SMAF-1
- Terminals: Solder plated, solderable per MIL-STD-750, Method 2026
- Polarity: Color Band denotes cathode end
- Approx. Weight: 0.00093 ounces, 0.027 grams
- Marking: ES1J

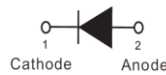

SMAF-1



Maximum Ratings ($T_A=25^{\circ}\text{C}$ unless otherwise noted)

PARAMETER	SYMBOL	LIMIT	UNIT
Maximum repetitive peak reverse voltage	V_{RRM}	600	V
Maximum rms voltage	V_{RMS}	420	V
Maximum dc blocking voltage	V_R	600	V
Maximum average forward current	$I_{F(AV)}$	1	A
Peak forward surge current : 8.3ms single half sine-wave superimposed on rated load	I_{FSM}	30	A
Typical forward voltage at 1A	V_F	1.65	V
Maximum dc reverse current at rated dc blocking voltage	I_R	5	μA
Typical junction capacitance Measured at 1MHz and applied $V_R=4\text{V}$	C_J	10	pF
Maximum reverse recovery time	(Note 3) T_{RR}	35	ns
Typical thermal resistance	(Note 1) $R_{\theta JA}$	150	$^{\circ}\text{C/W}$
	(Note 2) $R_{\theta JC}$	18	
Operating and storage temperature range	T_J, T_{STG}	-55 to +150	$^{\circ}\text{C}$

- Note :
1. Mounted on a FR4 PCB, single-sided copper, mini pad.
 2. Mounted on a FR4 PCB, single-sided copper, with 100cm² copper pad area
 3. Reverse Recovery Test Conditions : $I_F=0.5\text{A}$, $I_R=1\text{A}$, $I_{RR}=0.25\text{A}$



ES1JF-LE

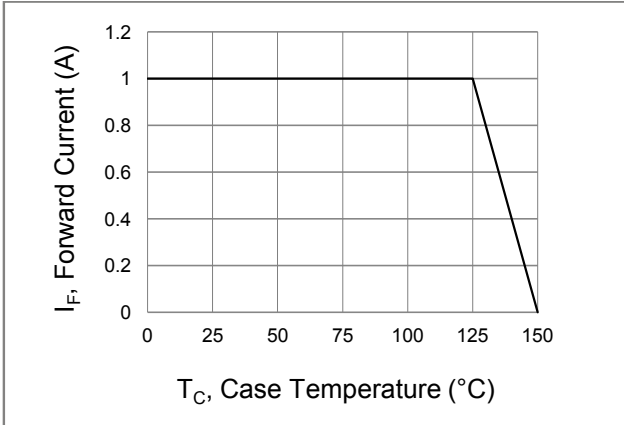

Fig.1 Forward Current Derating Curve

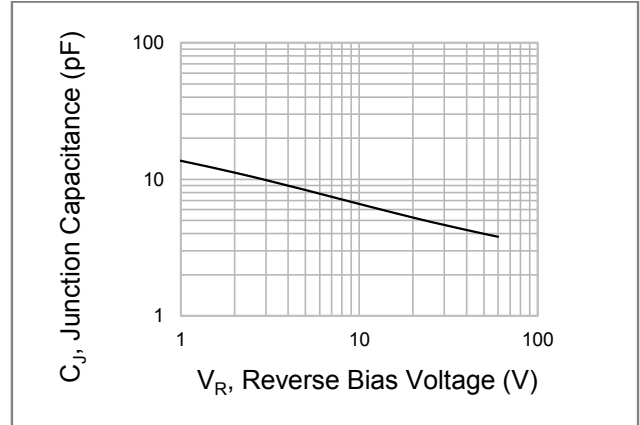

Fig.2 Typical Junction Capacitance

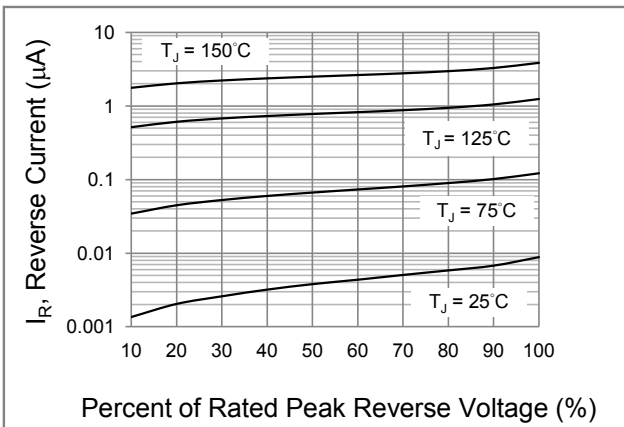

Fig.3 Typical Reverse Characteristics

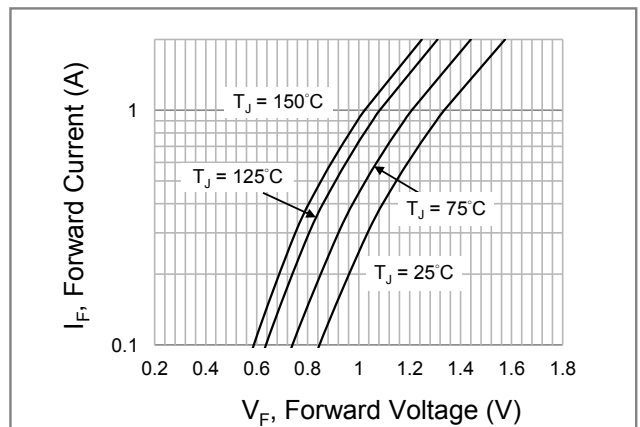
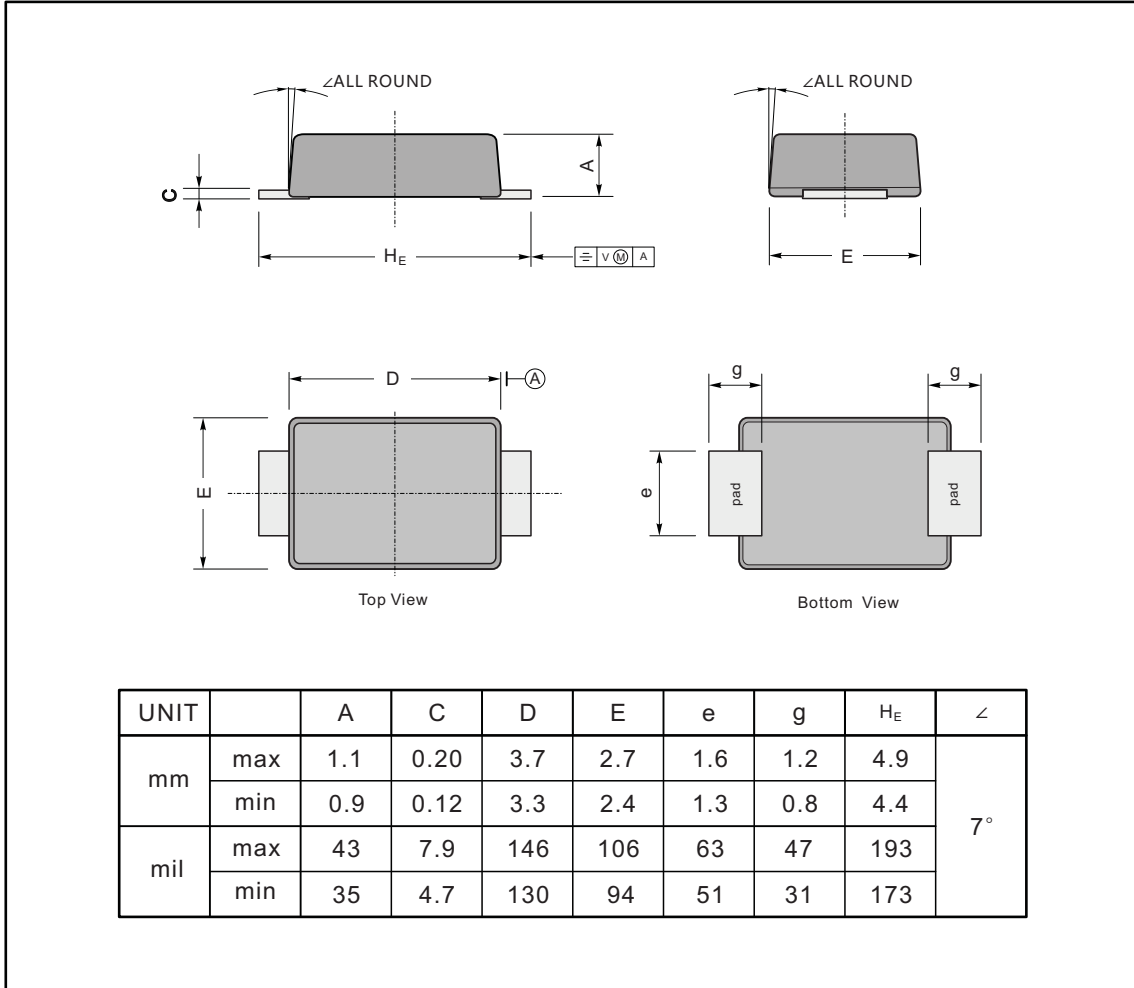

Fig.4 Typical Forward Characteristics



ES1JF-LE

Package Outline



Pad Layout

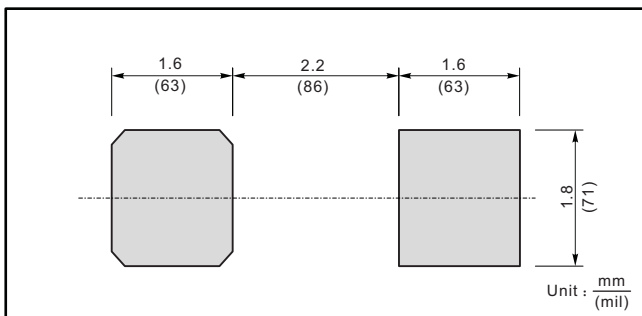



ES1JF-LE

Disclaimer

- Reproducing and modifying information of the document is prohibited without permission from Panjit International Inc..
- Panjit International Inc. reserves the rights to make changes of the content herein the document anytime without notification. Please refer to our website for the latest document.
- Panjit International Inc. disclaims any and all liability arising out of the application or use of any product including damages incidentally and consequentially occurred.
- Panjit International Inc. does not assume any and all implied warranties, including warranties of fitness for particular purpose, non-infringement and merchantability.
- Applications shown on the herein document are examples of standard use and operation. Customers are responsible in comprehending the suitable use in particular applications. Panjit International Inc. makes no representation or warranty that such applications will be suitable for the specified use without further testing or modification.
- The products shown herein are not designed and authorized for equipments requiring high level of reliability or relating to human life and for any applications concerning life-saving or life-sustaining, such as medical instruments, transportation equipment, aerospace machinery et cetera. Customers using or selling these products for use in such applications do so at their own risk and agree to fully indemnify Panjit International Inc. for any damages resulting from such improper use or sale.
- Since Panjit uses lot number as the tracking base, please provide the lot number for tracking when complaining.

单击下面可查看定价，库存，交付和生命周期等信息

[>>Panjit\(强茂\)](#)