

LS4148

FAST SWITCHING SURFACE MOUNT DIODES

VOLTAGE 100 Volts **POWER** 500 mWatts

QUADRO-MELF Unit : inch (mm)

FEATURES

- Fast switching Speed.
- Surface Mount Package Ideally Suited For Automatic Insertion.
- Silicon Epitaxial Planar Construction.
- Lead free in compliance with EU RoHS 2011/65/EU directive

MECHANICAL DATA

- Case: QUADRO MELF, Glass
- Terminals: Solderable per MIL-STD-750, Method 2026
- Polarity: Cathode Band
- Marking: Cathode Band Only
- Weight: 0.03 grams
- Packing information

T/R - 2.5K per 7" plastic reel

T/R - 10K per 13" plastic reel

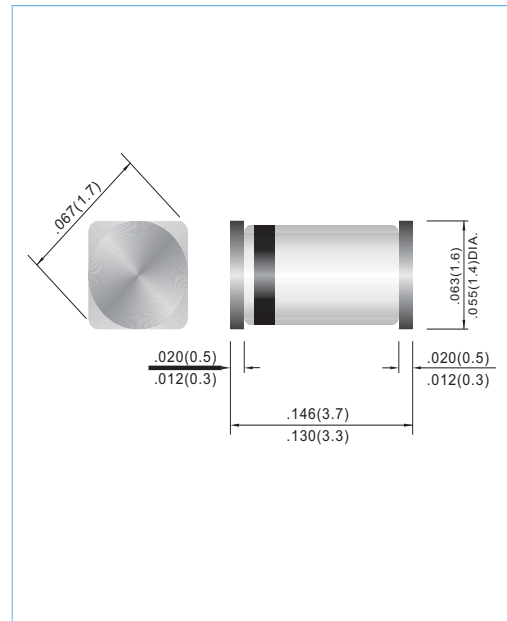

MAXIMUM RATINGS AND ELECTRICAL CHARACTERISTICS (T_J = 25°C unless otherwise noted)

PARAMETER	SYMBOL	LS4148	UNITS
Peak Reverse Voltage	V _{RM}	100	V
Maximum Average Forward Current at T _a =25 °C And f ≥50Hz	I _{F(AV)}	150	mA
Surge Forward Current at t < 1s and T _J = 25 °C	I _{FSM}	500	mA
Power Dissipation at Tamb= 25 °C	P _{TOT}	500	mW
Maximum Forward Voltage at I _F =10mA	V _F	1.0	V
Maximum Leakage Current at V _R =20V at V _R =75V at V _R =20V , T _J = 150°C	I _R	25 5 50	nA μA μA
Maximum Capacitance at V _F =V _R =0	C _J	4	pF
Maximum Reverse Recovery Time From I _F =-I _R =10mA to I _{RR} =-1mA , V _R =6V R _L =100 Ω	t _{tr}	4	ns
Typical Thermal Resistance	R _{θJA}	300	°C / W
Junction Temperature and Storage Temperature Range	T _J , T _S	-65 to +175	°C

NOTE:

1. C_J at V_R=0, f=1MHZ
2. From I_F=10mA to I_R=1mA, V_R=6Volts, R_L=100Ω

LS4148

RATING AND CHARACTERISTIC CURVES

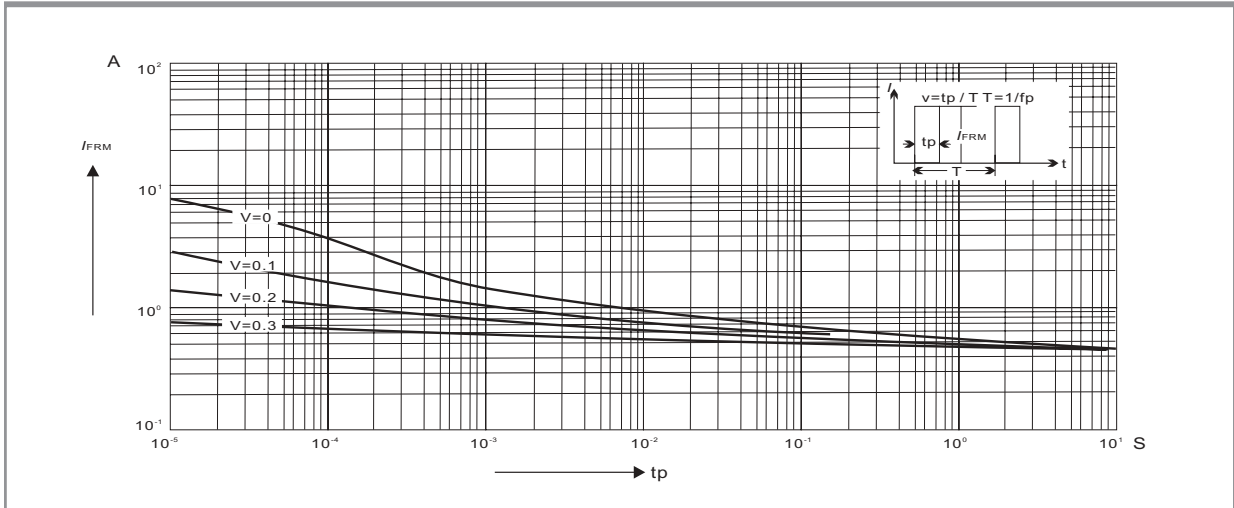

Fig.1 ADMISSIBLE REPETITIVE PEAK FORWARD CURRENT VERSUS PULSE DURATION

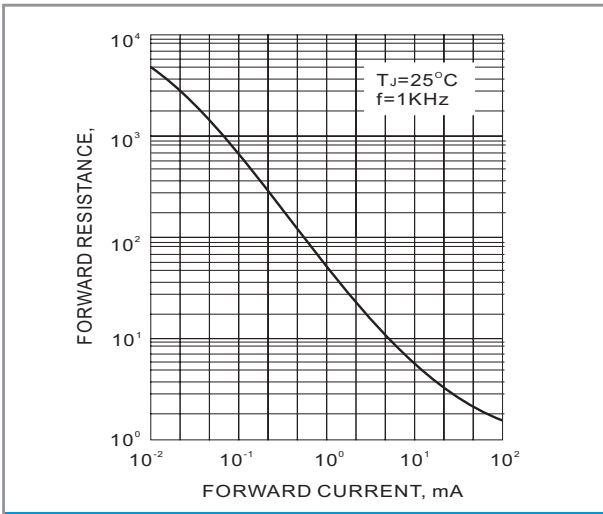

Fig.2-DYNAMIC FORWARD RESISTANCE VERSUS FORWARD CURRENT

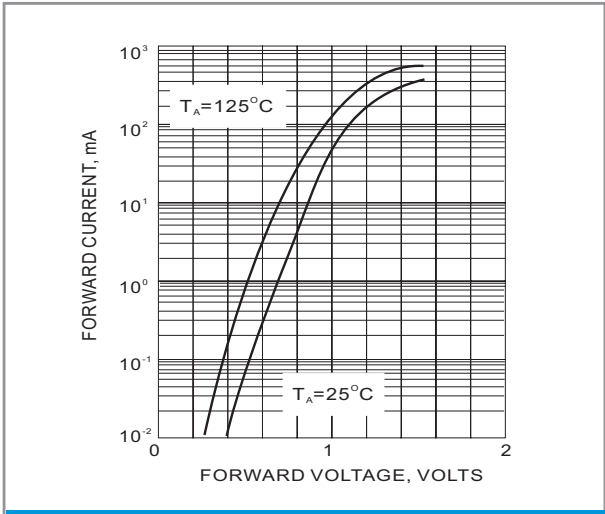

Fig.3 FORWARD CHARACTERISTICS

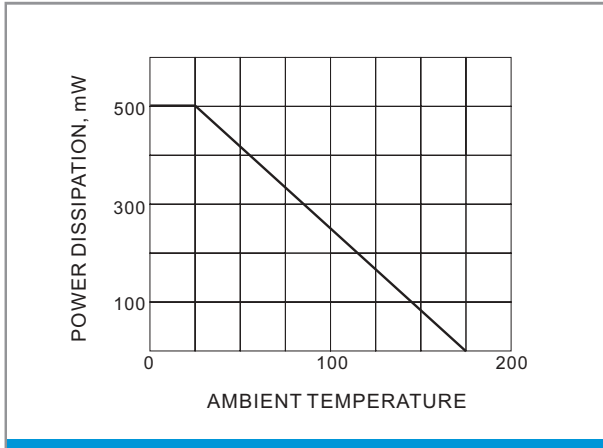

Fig.4 DERATING CURVE

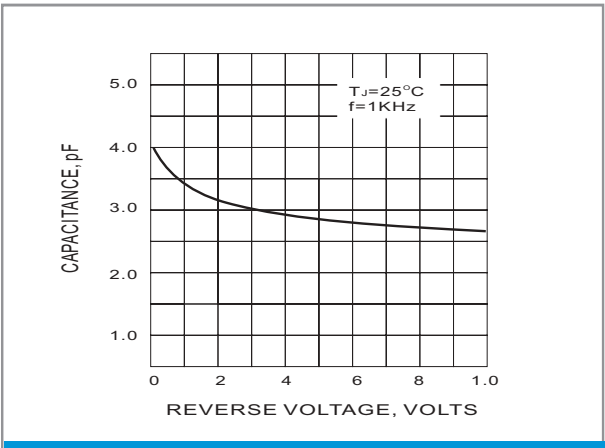
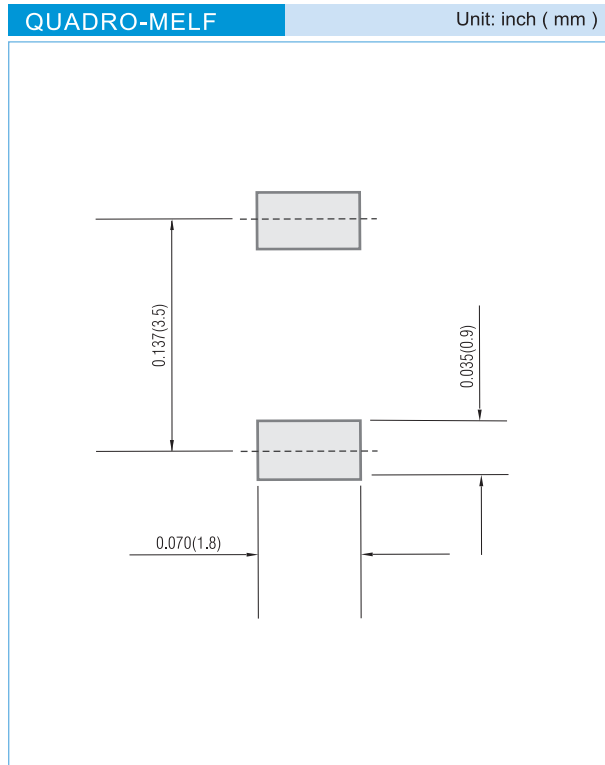

Fig.5 TYPICAL JUNCTION CAPACITANCE

LS4148

MOUNTING PAD LAYOUT



ORDER INFORMATION

- Packing information
- T/R - 10K per 13" plastic Reel
T/R - 2.5K per 7" plastic Reel

LS4148

Part No_packing code_Version

LS4148_R2_10001

For example :

RB500V-40_R2_00001



Packing Code XX				Version Code XXXXX		
Packing type	1 st Code	Packing size code	2 nd Code	HF or RoHS	1 st Code	2 nd ~5 th Code
Tape and Ammunition Box (T/B)	A	N/A	0	HF	0	serial number
Tape and Reel (T/R)	R	7"	1	RoHS	1	serial number
Bulk Packing (B/P)	B	13"	2			
Tube Packing (T/P)	T	26mm	X			
Tape and Reel (Right Oriented) (TRR)	S	52mm	Y			
Tape and Reel (Left Oriented) (TRL)	L	PANASERT T/B CATHODE UP (PBCU)	U			
FORMING	F	PANASERT T/B CATHODE DOWN (PBCD)	D			

LS4148

Disclaimer

- Reproducing and modifying information of the document is prohibited without permission from Panjit International Inc..
- Panjit International Inc. reserves the rights to make changes of the content herein the document anytime without notification. Please refer to our website for the latest document.
- Panjit International Inc. disclaims any and all liability arising out of the application or use of any product including damages incidentally and consequentially occurred.
- Panjit International Inc. does not assume any and all implied warranties, including warranties of fitness for particular purpose, non-infringement and merchantability.
- Applications shown on the herein document are examples of standard use and operation. Customers are responsible in comprehending the suitable use in particular applications. Panjit International Inc. makes no representation or warranty that such applications will be suitable for the specified use without further testing or modification.
- The products shown herein are not designed and authorized for equipments requiring high level of reliability or relating to human life and for any applications concerning life-saving or life-sustaining, such as medical instruments, transportation equipment, aerospace machinery et cetera. Customers using or selling these products for use in such applications do so at their own risk and agree to fully indemnify Panjit International Inc. for any damages resulting from such improper use or sale.
- Since Panjit uses lot number as the tracking base, please provide the lot number for tracking when complaining.

单击下面可查看定价，库存，交付和生命周期等信息

[>>Panjit\(强茂\)](#)