



SBM560VSS

ULTRA LOW VF SCHOTTKY RECTIFIER

VOLTAGE 60 Volt **CURRENT** 5 Ampere

FEATURES

- Ultra low forward voltage drop, low power loss
- High efficiency operation
- Lead free in compliance with EU RoHS 2011/65/EU directive

MECHANICAL DATA

- Case : Molded plastic, DO-201AD
- Terminals : Axial leads,solderable per MIL-STD-750, Method 2026
- Polarity : Color band denotes cathode end
- Approx weight : 0.0402 ounces, 1.142 grams

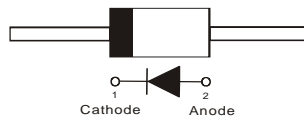

DO-201AD

Unit : inch(mm)

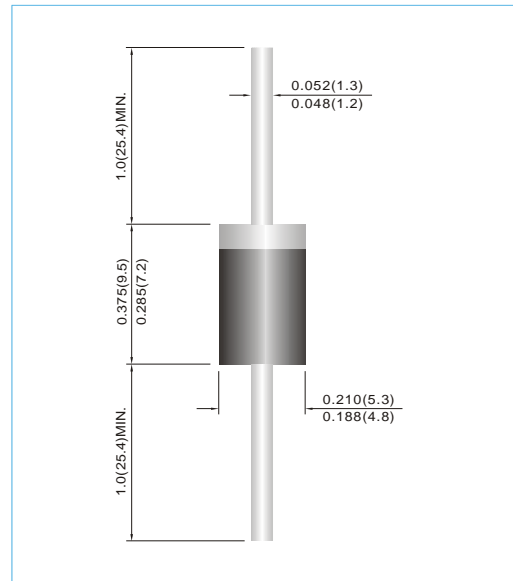

MAXIMUM RATINGS(T_A=25°C unless otherwise noted)

PARAMETER	SYMBOL	VALUE	UNIT
Maximum repetitive peak reverse voltage	V _{RRM}	60	V
Maximum rms voltage	V _{RMS}	42	V
Maximum dc blocking voltage	V _R	60	V
Maximum average forward rectified current	I _{F(AV)}	5	A
Peak forward surge current : 8.3ms single half sine-wave superimposed on rated load	I _{FSM}	120	A
Typical thermal resistance (Note 1)	R _{θJA} R _{θJL}	45 25	°C/W
Operating junction temperature range	T _J	-55 to + 150	°C
Storage temperature range	T _{STG}	-55 to + 150	°C

ELECTRICAL CHARACTERISTICS(T_A=25°C unless otherwise noted)

PARAMETER	SYMBOL	TEST CONDITIONS	MIN.	TYP.	MAX.	UNIT		
Breakdown voltage	V _{BR}	I _R =0.5mA	60	-	-	V		
Instantaneous forward voltage	V _F	I _F =1A I _F =3A I _F =5A T _J =25°C	-	0.33 0.4 0.46	-	V		
		I _F =1A I _F =3A T _J =125°C	-	0.24 0.36	-	V		
		Reverse current	I _R	V _R =48V	-	25	-	μA
		V _R =60V T _J =25°C T _J =125°C		-	- 8.5	220 -	μA mA	

Note : 1.The testing condition of the thermal resistance (junction to ambient and junction to lead) is based on 10mm lead length between two 10x10cm copper pad heatsinks.



SBM560VSS

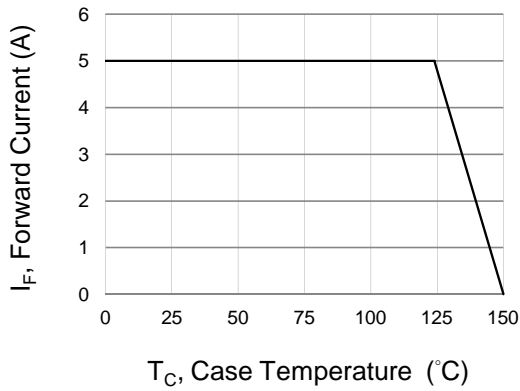

Fig.1 Forward Current Derating Curve

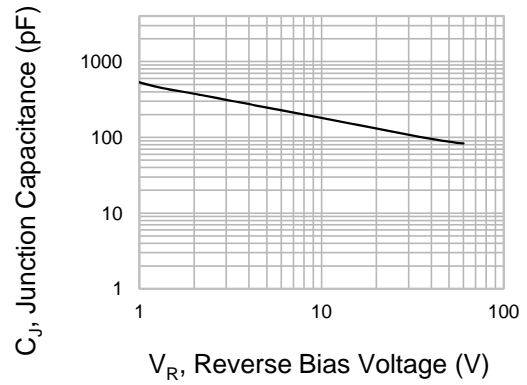

Fig.2 Typical Junction Capacitance

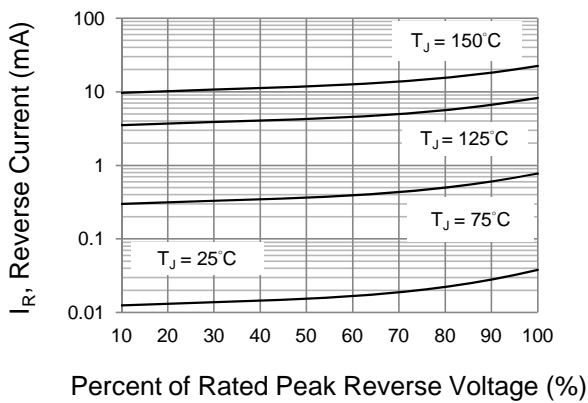

Fig.3 Typical Reverse Characteristics

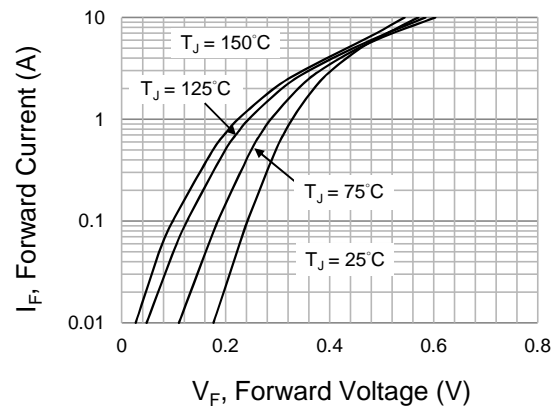

Fig.4 Typical Forward Characteristics

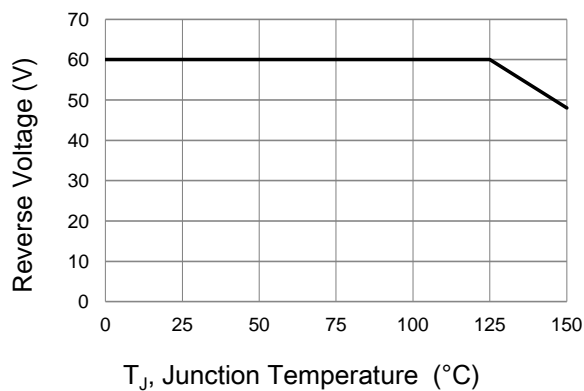

Fig.5 Operating Temperature Derating Curve



SBM560VSS

Part No_packing code_Version

SBM560VSS_AY_00001
 SBM560VSS_AY_10001
 SBM560VSS_B0_00001
 SBM560VSS_B0_10001
 SBM560VSS_R2_00001
 SBM560VSS_R2_10001

For example :

RB500V-40_R2_00001



Packing Code XX				Version Code XXXXX		
Packing type	1 st Code	Packing size code	2 nd Code	HF or RoHS	1 st Code	2 nd ~5 th Code
Tape and Ammunition Box (T/B)	A	N/A	0	HF	0	serial number
Tape and Reel (T/R)	R	7"	1	RoHS	1	serial number
Bulk Packing (B/P)	B	13"	2			
Tube Packing (T/P)	T	26mm	X			
Tape and Reel (Right Oriented) (TRR)	S	52mm	Y			
Tape and Reel (Left Oriented) (TRL)	L	PANASERT T/B CATHODE UP (PBCU)	U			
FORMING	F	PANASERT T/B CATHODE DOWN (PBCD)	D			



SBM560VSS

Disclaimer

- Reproducing and modifying information of the document is prohibited without permission from Panjit International Inc..
- Panjit International Inc. reserves the rights to make changes of the content herein the document anytime without notification. Please refer to our website for the latest document.
- Panjit International Inc. disclaims any and all liability arising out of the application or use of any product including damages incidentally and consequentially occurred.
- Panjit International Inc. does not assume any and all implied warranties, including warranties of fitness for particular purpose, non-infringement and merchantability.
- Applications shown on the herein document are examples of standard use and operation. Customers are responsible in comprehending the suitable use in particular applications. Panjit International Inc. makes no representation or warranty that such applications will be suitable for the specified use without further testing or modification.
- The products shown herein are not designed and authorized for equipments requiring high level of reliability or relating to human life and for any applications concerning life-saving or life-sustaining, such as medical instruments, transportation equipment, aerospace machinery et cetera. Customers using or selling these products for use in such applications do so at their own risk and agree to fully indemnify Panjit International Inc. for any damages resulting from such improper use or sale.
- Since Panjit uses lot number as the tracking base, please provide the lot number for tracking when complaining.

单击下面可查看定价，库存，交付和生命周期等信息

[>>Panjit\(强茂\)](#)