



SS2060LHE

SURFACE MOUNT LOW VF SCHOTTKY BARRIER RECTIFIER

VOLTAGE 60 Volt **CURRENT** 2 Ampere

SOD-123HE Unit : inch(mm)

FEATURES

- Fast switching speed
- Surface mount package ideally suited for automatic insertion
- Electrical identical standard JEDEC.
- High conductor
- Lead free in compliance with EU RoHS 2011/65/EU directive
- Green molding compound as per IEC61249 Std. . (Halogen Free)

MECHANICAL DATA

- Case: SOD-123HE, Plastic
- Terminals: Solderable per MIL-STD-750, Method 2026
- Apprx. Weight: 0.0006 ounces, 0.0184 grams
- Polarity: Color band denotes cathode end
- Marking: EX

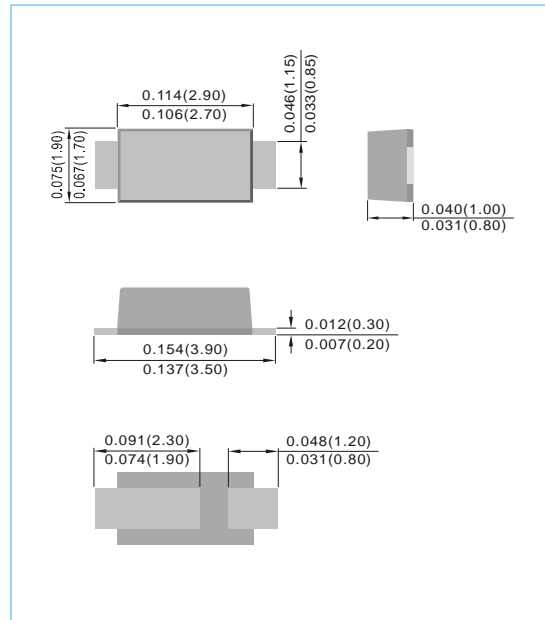
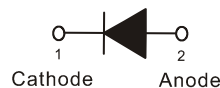
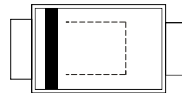

ABSOLUTE MAXIMUM RATINGS (T_A=25°C unless otherwise noted)

PARAMETER	SYMBOL	VALUE	UNITS
Reverse Voltage	V _R	60	V
Peak Reverse Voltage	V _{RRM}	60	V
Average Rectified Current at Temp=75°C	I _O	2	A
Peak Forward Surge Current:8.3ms single half sine-wave superimposed on rated load	I _{FSM}	50	A
Typical Thermal Resistance, Junction to Ambient (Note 1) Junction to Case (Note 1)	R _{θJA} R _{θJC}	200 15	°C/W
Operating Junction Temperature and Storage Temperature Range	T _J , T _{STG}	-55 to +150	°C

ELECTRICAL CHARACTERISTICS (T_A=25°C unless otherwise noted)

PARAMETER	SYMBOL	Test Condition	MIN.	TYP.	MAX.	UNITS
Reverse Breakdown Voltage	V _(BR)	I _R =1mA	60	--	--	V
Reverse Current	I _R	V _R =60 V	--	--	100	μA
Forward Voltage	V _F	I _F =1.0A I _F =2.0A	--	0.49 0.62	-- 0.67	V
Typical Junction Capacitance	C _J	V _R =0V, f=1.0MHz	--	230	--	pF

NOTES:

1. Mounted on 48cm² FR-4 PCB board.



SS2060LHE

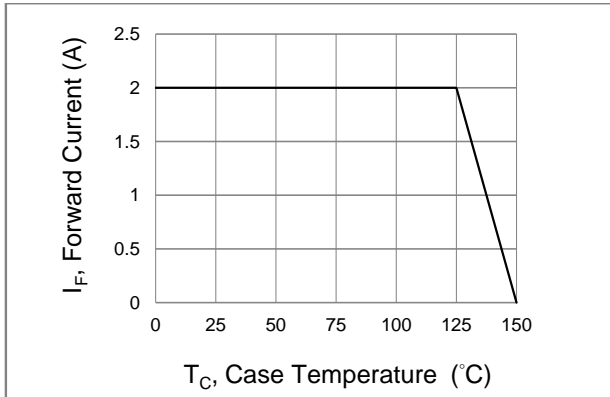

Fig.1 Forward Current Derating Curve

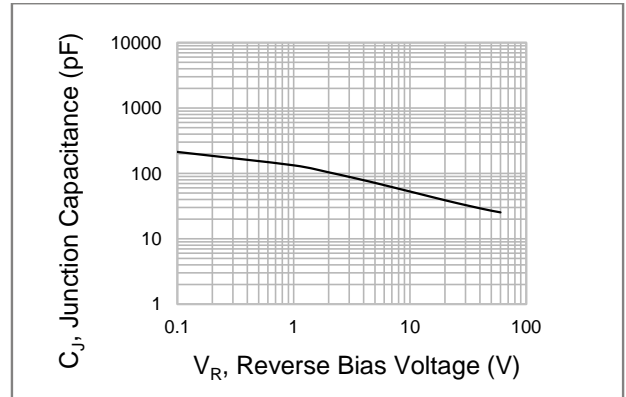

Fig.2 Typical Junction Capacitance

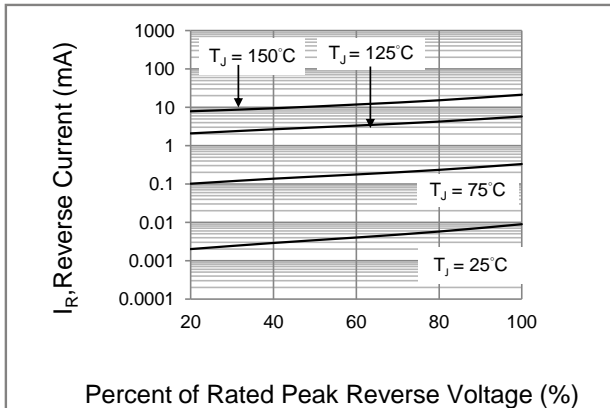

Fig.3 Typical Reverse Characteristics

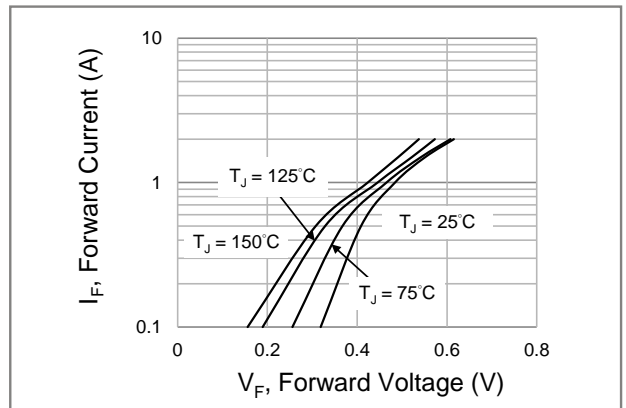

Fig.4 Typical Forward Characteristics

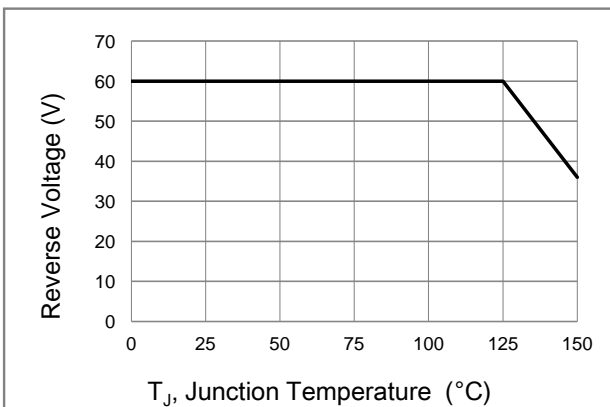

Fig.5 Operating Temperature Derating Curve



SS2060LHE

MOUNTING PAD LAYOUT

SOD-123HE

Unit : inch(mm)

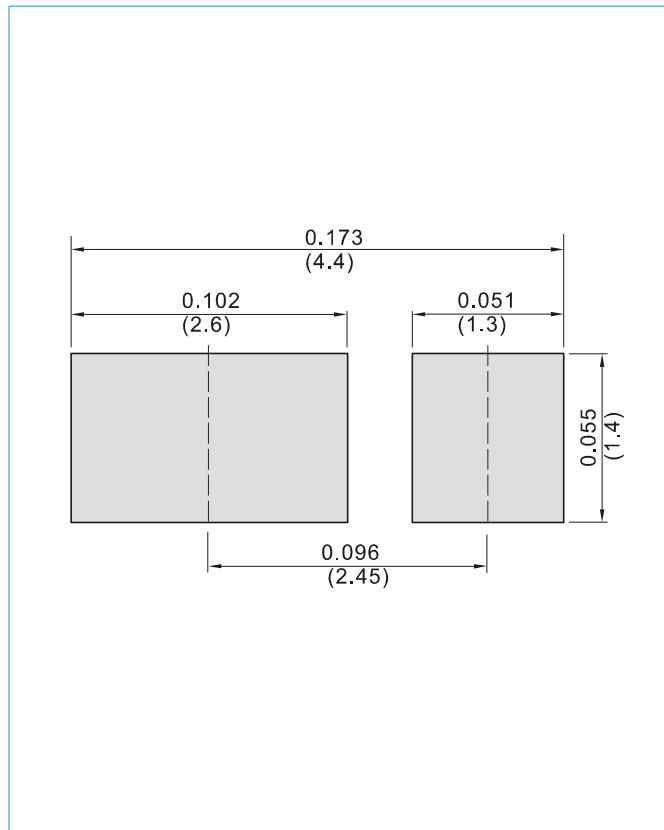

ORDER INFORMATION

- Packing information
T/R - 10K per 13" plastic Reel
T/R - 3K per 7" plastic Reel



SS2060LHE

Part No_packing code_Version

SS2060LHE_R1_00001

SS2060LHE_R2_00001

For example :

RB500V-40_R2_00001

Part No.

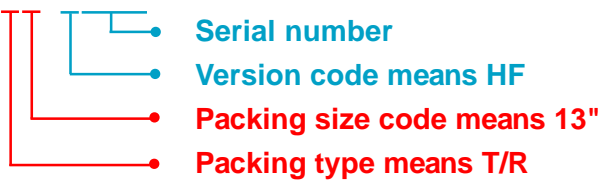

Packing Code XX				Version Code XXXXX		
Packing type	1 st Code	Packing size code	2 nd Code	HF or RoHS	1 st Code	2 nd -5 th Code
Tape and Ammunition Box (T/B)	A	N/A	0	HF	0	serial number
Tape and Reel (T/R)	R	7"	1	RoHS	1	serial number
Bulk Packing (B/P)	B	13"	2			
Tube Packing (T/P)	T	26mm	X			
Tape and Reel (Right Oriented) (TRR)	S	52mm	Y			
Tape and Reel (Left Oriented) (TRL)	L	PANASERT T/B CATHODE UP (PBCU)	U			
FORMING	F	PANASERT T/B CATHODE DOWN (PBCD)	D			



SS2060LHE

Disclaimer

- Reproducing and modifying information of the document is prohibited without permission from Panjit International Inc..
- Panjit International Inc. reserves the rights to make changes of the content herein the document anytime without notification. Please refer to our website for the latest document.
- Panjit International Inc. disclaims any and all liability arising out of the application or use of any product including damages incidentally and consequentially occurred.
- Panjit International Inc. does not assume any and all implied warranties, including warranties of fitness for particular purpose, non-infringement and merchantability.
- Applications shown on the herein document are examples of standard use and operation. Customers are responsible in comprehending the suitable use in particular applications. Panjit International Inc. makes no representation or warranty that such applications will be suitable for the specified use without further testing or modification.
- The products shown herein are not designed and authorized for equipments requiring high level of reliability or relating to human life and for any applications concerning life-saving or life-sustaining, such as medical instruments, transportation equipment, aerospace machinery et cetera. Customers using or selling these products for use in such applications do so at their own risk and agree to fully indemnify Panjit International Inc. for any damages resulting from such improper use or sale.
- Since Panjit uses lot number as the tracking base, please provide the lot number for tracking when complaining.

单击下面可查看定价，库存，交付和生命周期等信息

[>>Panjit\(强茂\)](#)