



1SS387FN2

SURFACE MOUNT SWITCHING DIODES

VOLTAGE 80 Volt **POWER** 300mWatt

DFN 2L Unit : inch(mm)

FEATURES

- Fast switching Speed.
- Electrically Identical to Standard JEDEC
- Surface Mount Package Ideally Suited for Automatic Insertion.
- Lead free in compliance with EU RoHS 2.0
- Green molding compound as per IEC 61249 standard

MECHANICAL DATA

- Case : DFN 2L plastic case.
- Terminals : Solderable per MIL-STD-750, Method 2026
- Weight : 0.00004 ounces, 0.0011grams
- Marking Code : BZ
- Polarity : Color band denotes cathode end

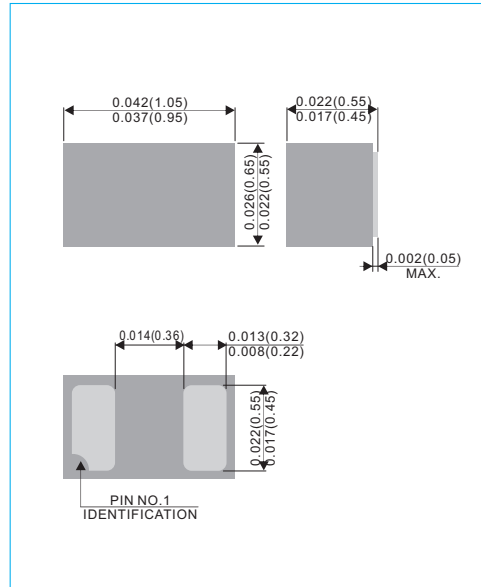
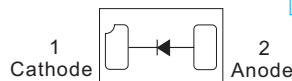

ABSOLUTE RATINGS (T_A = 25°C, unless otherwise noted)

PARAMETER	SYMBOL	1SS387FN2	UNITS
Reverse Voltage	V _R	80	V
Peak Reverse Voltage	V _{RRM}	85	V
Maximum DC Blocking Voltage	V _{DC}	80	V
Maximum Average Forward Current at T _A = 25 °C	I _{F(AV)}	150	mA
Peak Forward Surge Current, @ 8.33ms AC Half Wave @ 10ms AC Half Wave	I _{FSM}	2.5 2.3	A
Power Dissipation Derate Above 25 °C	P _D	300	mW
Operating Junction and Storage Temperature Range	T _J , T _{STG}	-55 to +150	°C

THERMAL CHARACTERISTICS

PARAMETER	SYMBOL	1SS387FN2	UNITS
Typical Thermal Resistance	R _{θJA}	400	°C / W



1SS387FN2

ELECTRICAL CHARACTERISTICS ($T_A=25^{\circ}\text{C}$, unless otherwise noted)

PARAMETER	SYMBOL	TEST CONDITIONS	MIN	TPY	MAX	UNITS
Maximum Forward Voltage	V_F	$I_F=1\text{mA}$ $I_F=10\text{mA}$ $I_F=100\text{mA}$	-	0.62 0.75 0.98	0.715 0.855 1.2	V
Reverse Leakage Current	I_R	$V_R=30\text{V}$ $V_R=80\text{V}$	-		0.1 0.5	μA
Maximum Total Capacitance	C_T	$V_R=0\text{V}$, $f=1\text{MHz}$	-	0.5		pF
Maximum Reverse Recovery Time	t_{rr}	$I_F=10\text{mA}$, $I_R=1\text{mA}$ $V_R=6\text{V}$, $R_L=100\Omega$	-	1.6		ns

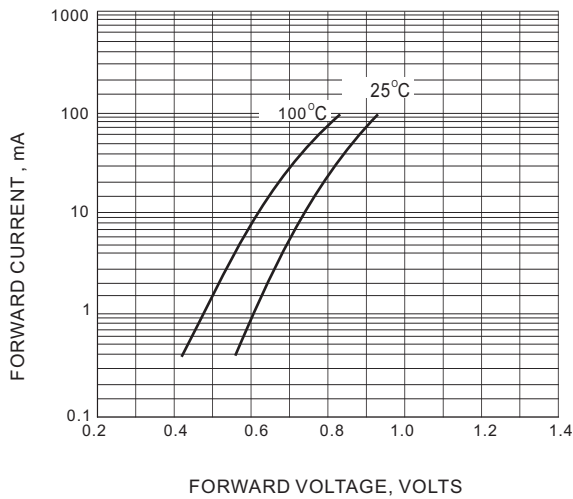

FIG. 1-TYPICAL FORWARD CHARACTERISTIC

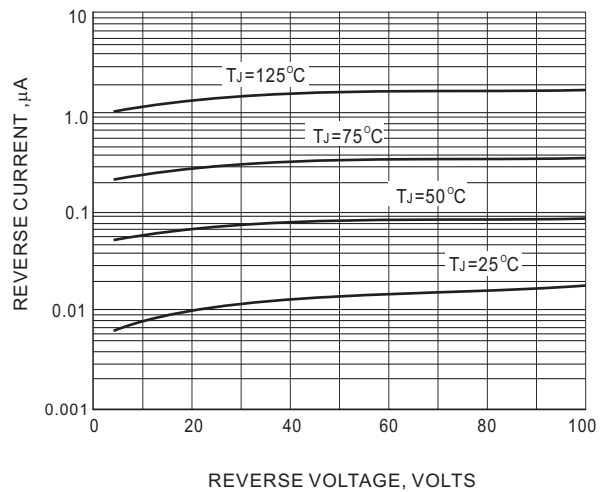

FIG. 2-TYPICAL REVERSE CHARACTERISTICS

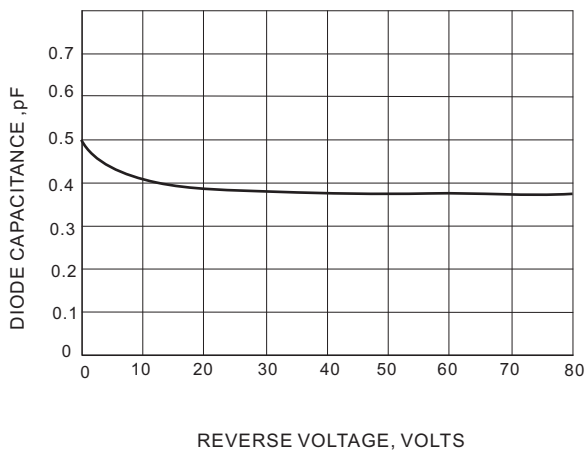

FIG. 3 TYPICAL JUNCTION CAPACITANCE

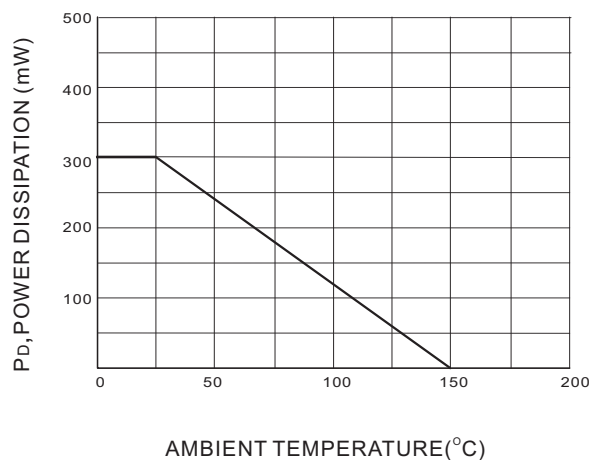

FIG. 4 POWER DERATING CURVE



1SS387FN2

MOUNTING PAD LAYOUT

DFN 2L

Unit : inch(mm)

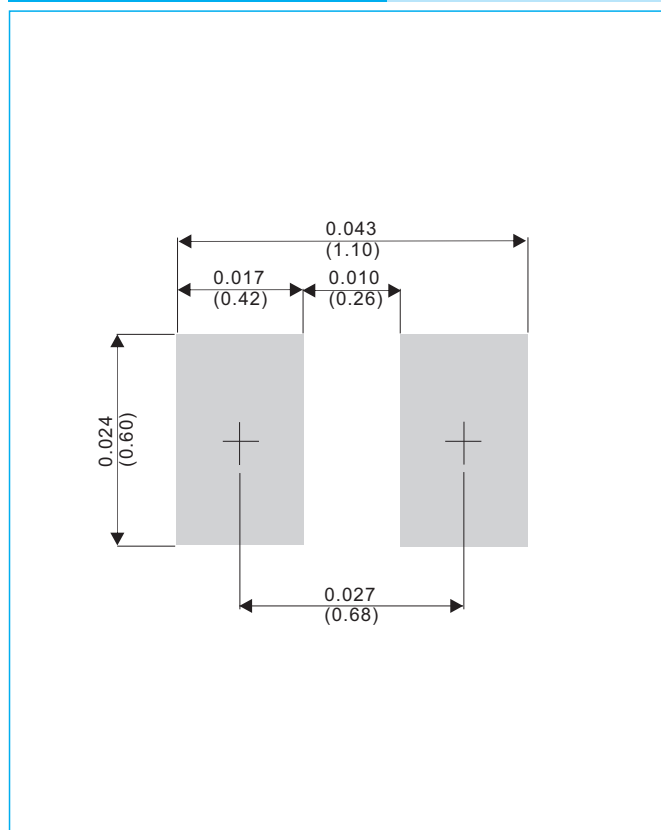

ORDER INFORMATION

- Packing information
T/R -8K per 7" plastic Reel



1SS387FN2

Part No_packing code_Version

1SS387FN2_R1_00001

For example :

RB500V-40_R2_00001



Packing Code XX				Version Code XXXXX		
Packing type	1 st Code	Packing size code	2 nd Code	HF or RoHS	1 st Code	2 nd ~5 th Code
Tape and Ammunition Box (T/B)	A	N/A	0	HF	0	serial number
Tape and Reel (T/R)	R	7"	1	RoHS	1	serial number
Bulk Packing (B/P)	B	13"	2			
Tube Packing (T/P)	T	26mm	X			
Tape and Reel (Right Oriented) (TRR)	S	52mm	Y			
Tape and Reel (Left Oriented) (TRL)	L	PANASERT T/B CATHODE UP (PBCU)	U			
FORMING	F	PANASERT T/B CATHODE DOWN (PBCD)	D			



1SS387FN2

Disclaimer

- Reproducing and modifying information of the document is prohibited without permission from Panjit International Inc..
- Panjit International Inc. reserves the rights to make changes of the content herein the document anytime without notification. Please refer to our website for the latest document.
- Panjit International Inc. disclaims any and all liability arising out of the application or use of any product including damages incidentally and consequentially occurred.
- Panjit International Inc. does not assume any and all implied warranties, including warranties of fitness for particular purpose, non-infringement and merchantability.
- Applications shown on the herein document are examples of standard use and operation. Customers are responsible in comprehending the suitable use in particular applications. Panjit International Inc. makes no representation or warranty that such applications will be suitable for the specified use without further testing or modification.
- The products shown herein are not designed and authorized for equipments requiring high level of reliability or relating to human life and for any applications concerning life-saving or life-sustaining, such as medical instruments, transportation equipment, aerospace machinery et cetera. Customers using or selling these products for use in such applications do so at their own risk and agree to fully indemnify Panjit International Inc. for any damages resulting from such improper use or sale.
- Since Panjit uses lot number as the tracking base, please provide the lot number for tracking when complaining.

单击下面可查看定价，库存，交付和生命周期等信息

[>>Panjit\(强茂\)](#)