



BR38F~BR320F

SURFACE MOUNT SCHOTTKY BARRIER RECTIFIER

VOLTAGE 80-200Volt **CURRENT** 3 Ampere

FEATURES

- Plastic package has Underwriters Laboratory Flammability Classification 94V-O
- For surface mounted applications in order to optimize board space
- Ultra thin profile package for space constrained utilization
- Package suitable for automated handling
- Low power loss,high efficiency
- High surge capacity
- Lead free in compliance with EU RoHS2.0 (2011/65/EU & 2015/865/EU directive)
- Green molding compound as per IEC61249 Std. . (Halogen Free)

MECHANICAL DATA

- Case: SMBF molded plastic
- Terminals: Solder plated, solderable per MIL-STD-750,Method 2026
- Approx. Weight: 0.0018 ounces, 0.05 grams
- Polarity: Color band denotes cathode end
- Marking: Part number

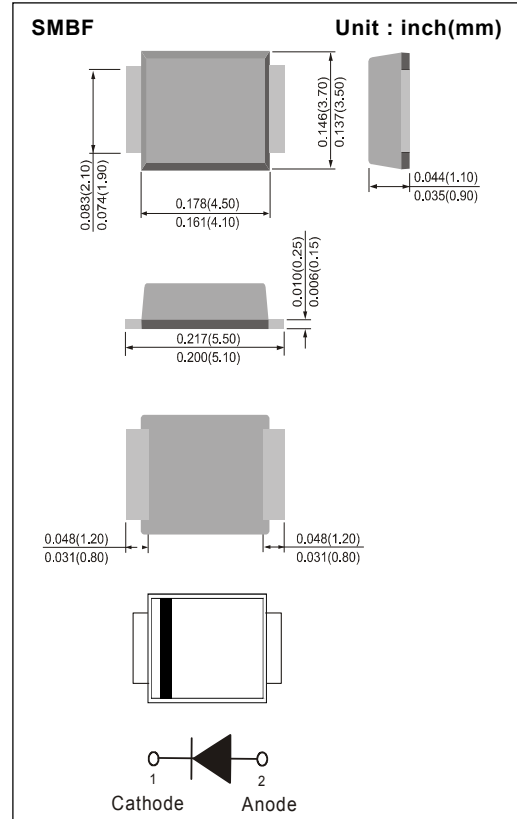

MAXIMUM RATINGS AND ELECTRICAL CHARACTERISTICS (Ta=25°C unless otherwise noted)

PARAMETER	SYMBOL	BR38F	BR39F	BR310F	BR315F	BR320F	UNITS
Recurrent Peak Reverse Voltage	V_{RRM}	80	90	100	150	200	V
RMS Voltage	V_{RMS}	56	63	70	105	140	V
DC Blocking Voltage	V_R	80	90	100	150	200	V
Average Forward Current	$I_{F(AV)}$	3					A
Peak Forward Surge Current : 8.3ms single half sine-wave superimposed on rated load	I_{FSM}	80					A
Forward Voltage at 3A	V_F	0.8			0.9		V
DC Reverse Current at Rated DC Blocking Voltage	I_R	0.05					mA
Typical Junction Capacitance ($V_R=4V, f=1MHz$)	C_J	120			100	70	pF
Typical Thermal Resistance ,Junction to Lead (Note 1) Junction to Ambient (Note 2)	$R_{\theta JL}$ $R_{\theta JA}$	17 135					°C / W
Operating Junction Temperature and Storage Temperature Range	T_J, T_{STG}	-65 to +150					°C

NOTES :

1. Mounted on FR-4 PCB, single-sided copper, with 100cm² copper pad area.
2. Mounted on FR-4 PCB, single-sided copper, mini pad.



BR38F~BR320F

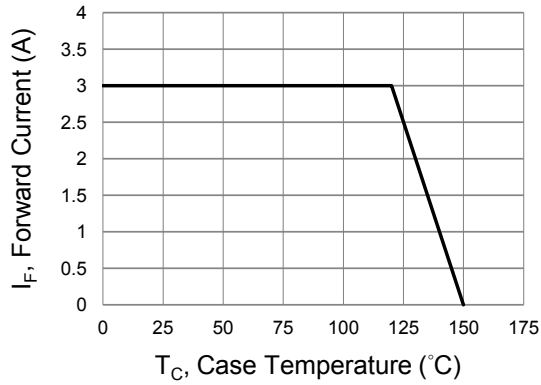

Fig.1 Forward Current Derating Curve

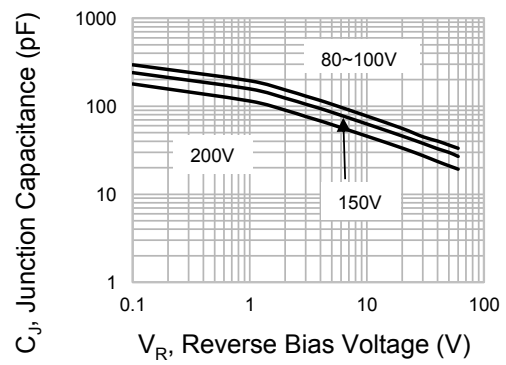

Fig.2 Typical Junction Capacitance

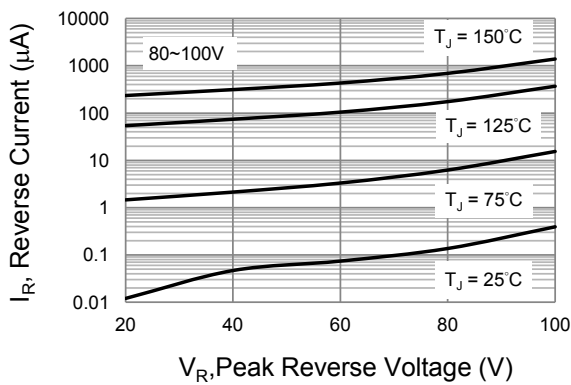

Fig.3 Typical Reverse Characteristics

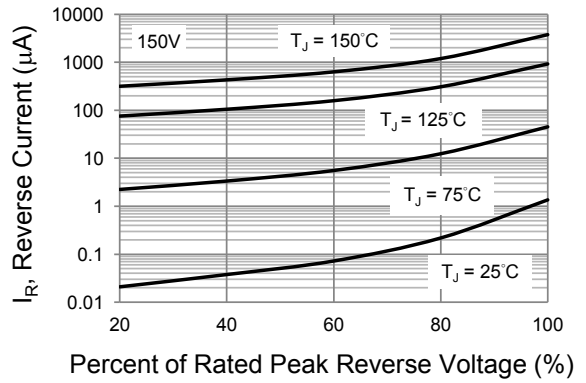

Fig.4 Typical Reverse Characteristics

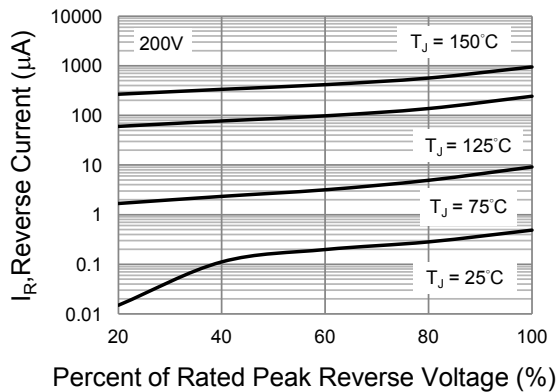

Fig.5 Typical Reverse Characteristics

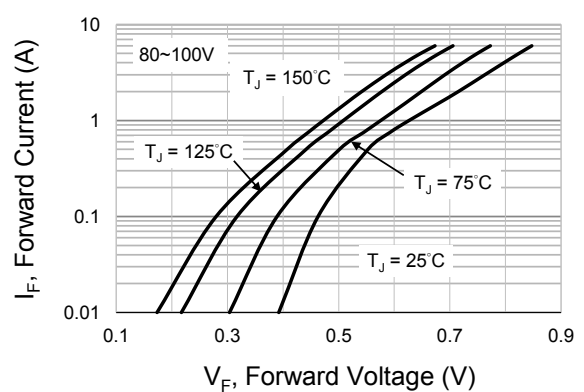

Fig.6 Typical Forward Characteristics



BR38F~BR320F

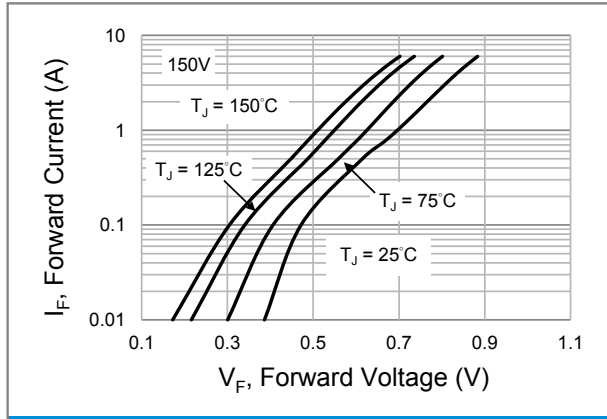

Fig.7 Typical Forward Characteristics

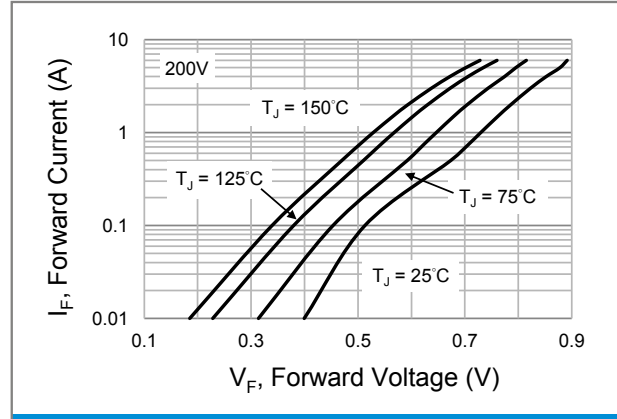

Fig.8 Typical Forward Characteristics

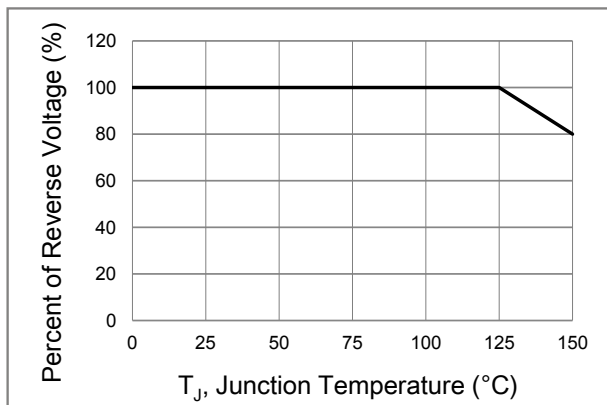

Fig.9 Operating Temperature Derating Curve



BR38F~BR320F

PART NO PACKING CODE VERSION

Part No Packing Code	Package Type	Packing Type	Marking	Version
BR38F_R2_00001	SMBF	5K pcs / 13" reel	BR38F	Halogen free

MOUNTING PAD LAYOUT

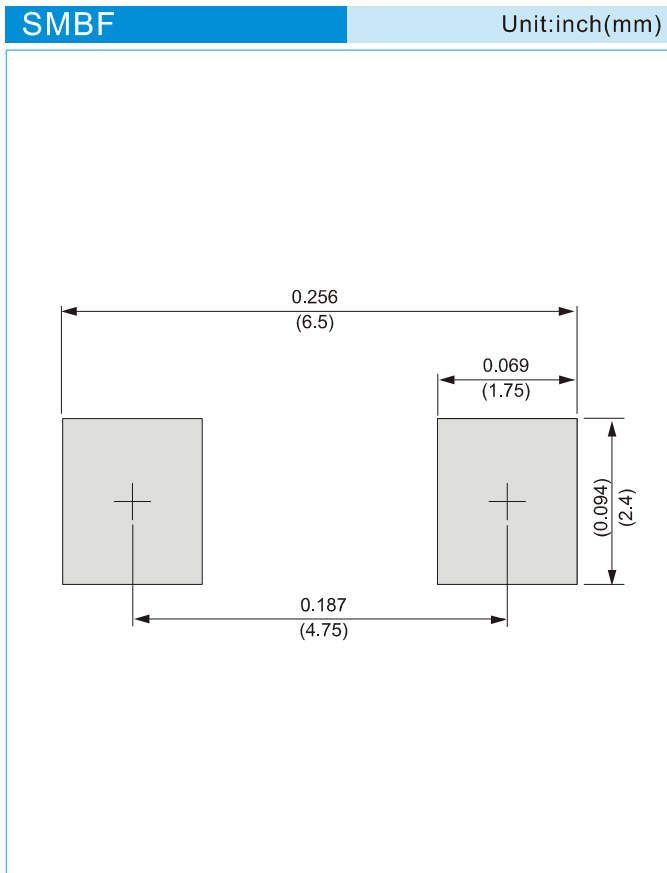



BR38F~BR320F

Disclaimer

- Reproducing and modifying information of the document is prohibited without permission from Panjit International Inc..
- Panjit International Inc. reserves the rights to make changes of the content herein the document anytime without notification. Please refer to our website for the latest document.
- Panjit International Inc. disclaims any and all liability arising out of the application or use of any product including damages incidentally and consequentially occurred.
- Panjit International Inc. does not assume any and all implied warranties, including warranties of fitness for particular purpose, non-infringement and merchantability.
- Applications shown on the herein document are examples of standard use and operation. Customers are responsible in comprehending the suitable use in particular applications. Panjit International Inc. makes no representation or warranty that such applications will be suitable for the specified use without further testing or modification.
- The products shown herein are not designed and authorized for equipments requiring high level of reliability or relating to human life and for any applications concerning life-saving or life-sustaining, such as medical instruments, transportation equipment, aerospace machinery et cetera. Customers using or selling these products for use in such applications do so at their own risk and agree to fully indemnify Panjit International Inc. for any damages resulting from such improper use or sale.
- Since Panjit uses lot number as the tracking base, please provide the lot number for tracking when complaining.

单击下面可查看定价，库存，交付和生命周期等信息

[>>Panjit\(强茂\)](#)