



MURC4J / MUR460M

SUPERFAST RECOVERY RECTIFIERS

Voltage

600 V

Current

4 A

Features

- Silicon epitaxial high-speed diodes
- Soft recovery characteristics
- Low forward voltage, high current capability
- Hermetically sealed.
- Low leakage
- High surge capacity
- Lead free in compliance with EU RoHS 2.0
- Green molding compound as per IEC 61249 standard

Mechanical Data

- Case: Molded plastic, SMC, DO-201AD
- Terminals: Solder plated, solderable per MIL-STD-750, Method 2026
- Polarity: Color Band denotes cathode end
- SMC Approx. Weight: 0.0082 ounces, 0.2325 grams
- DO-201AD Approx. Weight: 0.04 ounces, 1.142 grams
- Marking: Part number

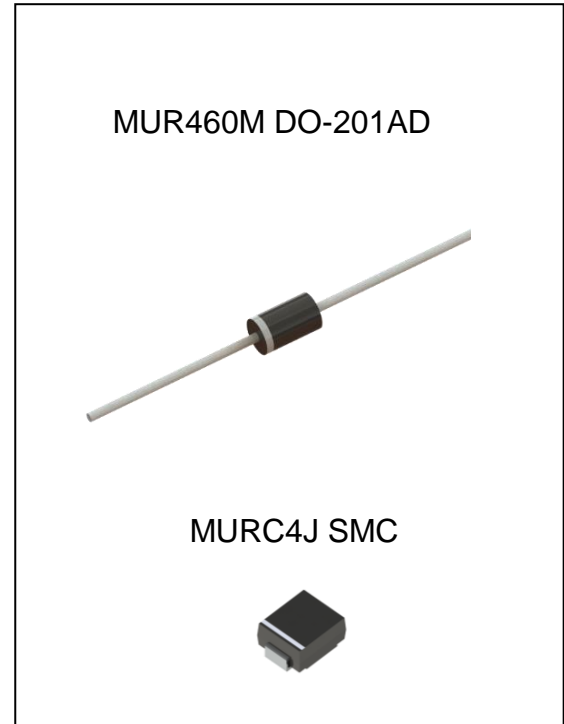
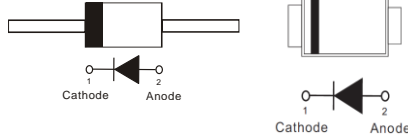

Maximum Ratings ($T_A=25^{\circ}\text{C}$ unless otherwise noted)

PARAMETER	SYMBOL	LIMIT	UNIT
Maximum repetitive peak reverse voltage	V_{RRM}	600	V
Maximum rms voltage	V_{RMS}	420	V
Maximum dc blocking voltage	V_R	600	V
Maximum average forward current	$I_{F(AV)}$	4	A
Peak forward surge current : 8.3ms single half sine-wave superimposed on rated load	I_{FSM}	110	A
Maximum forward voltage at 4A	V_F	1.28	V
Maximum dc reverse current at rated dc blocking voltage	I_R	5	μA
Maximum reverse recovery time	(Note 4)	T_{RR}	50 ns
Typical thermal resistance	SMC(Note 3)	$R_{\theta JA}$	125
	SMC(Note 1)	$R_{\theta JC}$	14
	DO-201AD(Note 2)	$R_{\theta JL}$	24
Operating and storage temperature range	T_J, T_{STG}	-55 to +175	$^{\circ}\text{C}$

Note : 1. Mounted on a FR4 PCB, single-sided copper, with 100cm² copper pad area

2. The testing condition of the thermal resistance (junction to lead) is based on 10 mm lead length between two 10cm x 10cm x 0.5mm copper pad

3. Mounted on a FR4 PCB, single-sided copper, mini pad.

4. Reverse Recovery Test Conditions : $I_F=0.5\text{A}$, $I_R=1\text{A}$, Recover to 0.25A



MURC4J / MUR460M

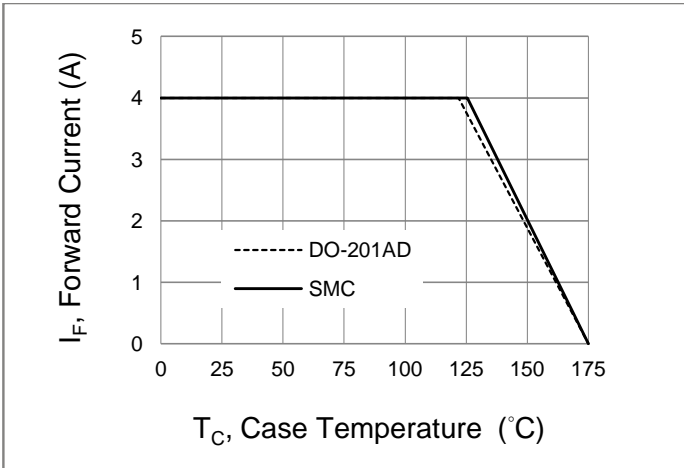

Fig.1 Forward Current Derating Curve

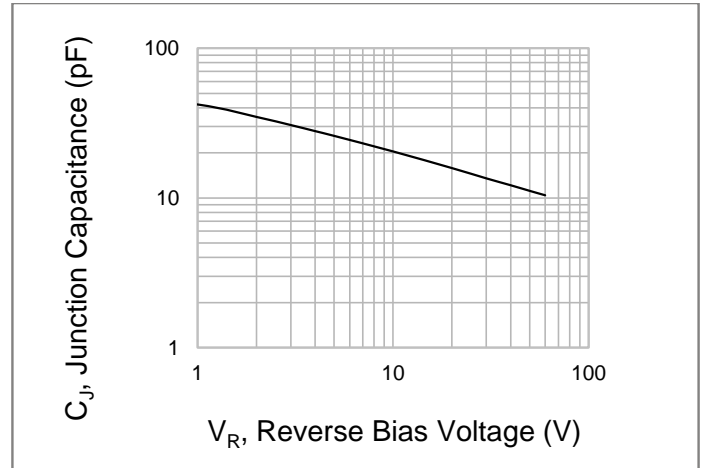

Fig.2 Typical Junction Capacitance

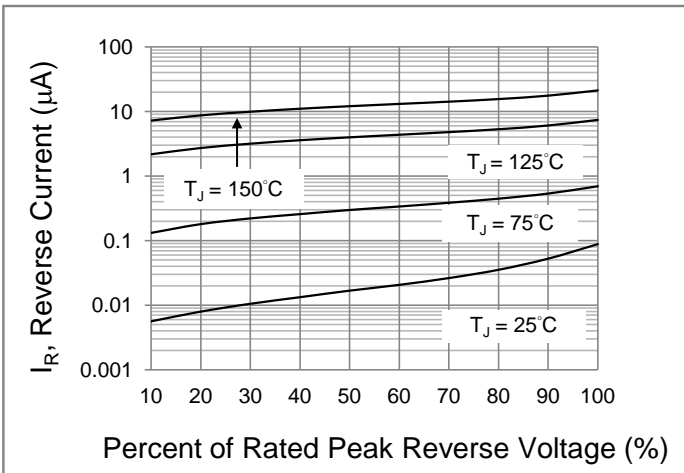

Fig.3 Typical Reverse Characteristics

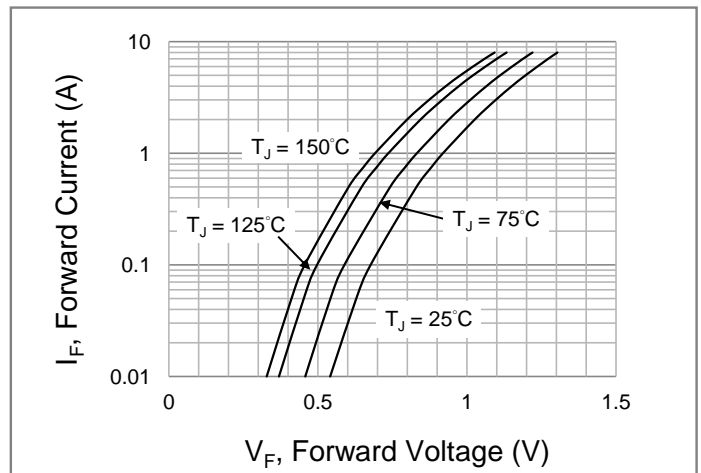

Fig.4 Typical Forward Characteristics



MURC4J / MUR460M

PART NO PACKING CODE VERSION

PART NO PACKING CODE	Package Type	Packing type	Marking	Version
MUR460M_AY_00001	DO-201AD	1.25K pcs / TB 52mm	MUR460M	Halogen free
MURC4J_R1_00001	SMC	0.8K pcs / 7" reel	MURC4J	Halogen free

MOUNTING PAD LAYOUT

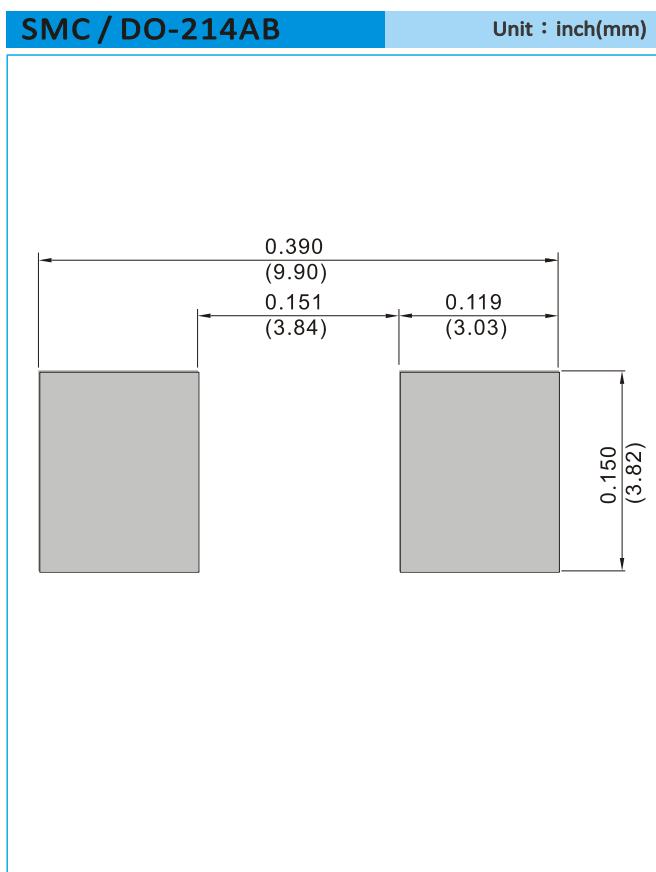



MURC4J / MUR460M

SMC / DO-214AB

Unit : inch(mm)

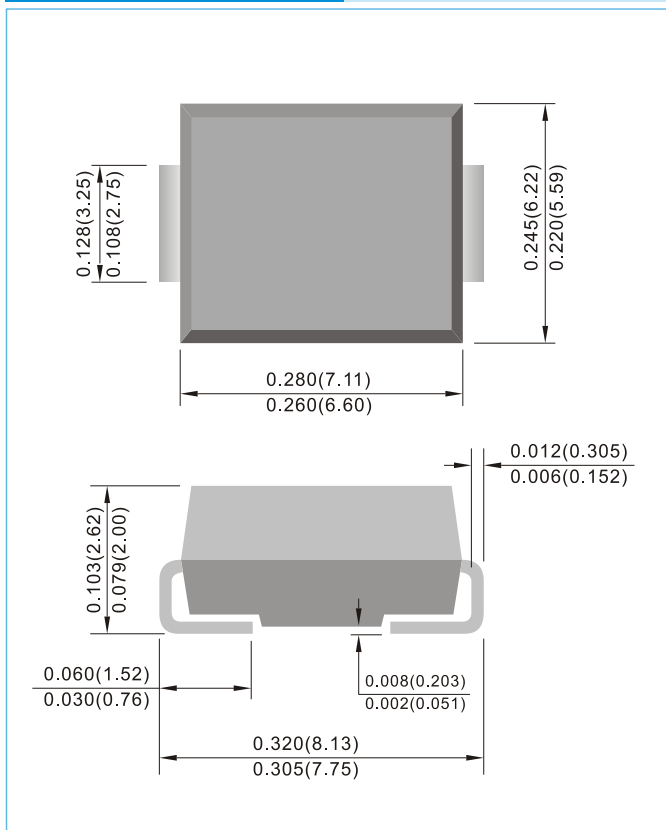

DO-201AD

Unit : inch(mm)

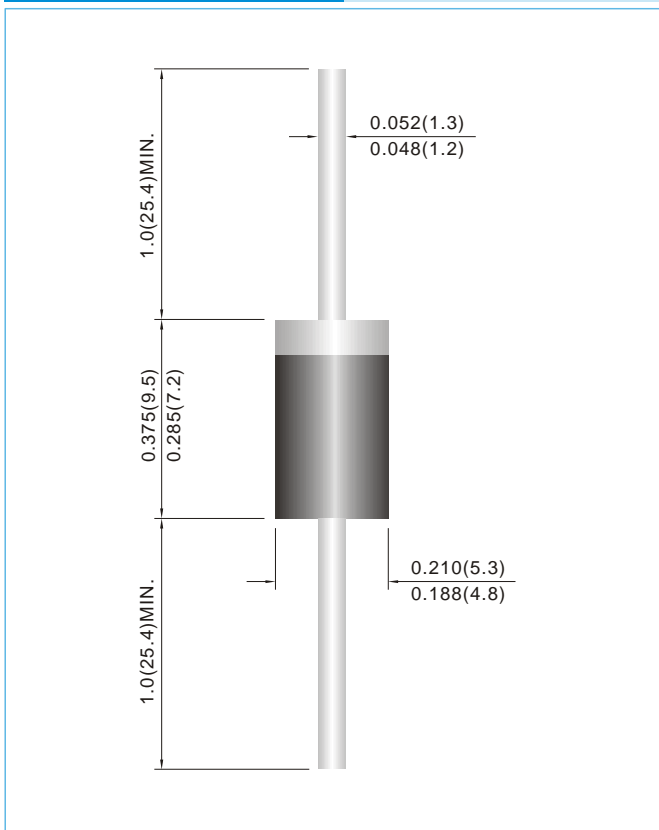



MURC4J / MUR460M

Disclaimer

- Reproducing and modifying information of the document is prohibited without permission from Panjit International Inc..
- Panjit International Inc. reserves the rights to make changes of the content herein the document anytime without notification. Please refer to our website for the latest document.
- Panjit International Inc. disclaims any and all liability arising out of the application or use of any product including damages incidentally and consequentially occurred.
- Panjit International Inc. does not assume any and all implied warranties, including warranties of fitness for particular purpose, non-infringement and merchantability.
- Applications shown on the herein document are examples of standard use and operation. Customers are responsible in comprehending the suitable use in particular applications. Panjit International Inc. makes no representation or warranty that such applications will be suitable for the specified use without further testing or modification.
- The products shown herein are not designed and authorized for equipments requiring high level of reliability or relating to human life and for any applications concerning life-saving or life-sustaining, such as medical instruments, transportation equipment, aerospace machinery et cetera. Customers using or selling these products for use in such applications do so at their own risk and agree to fully indemnify Panjit International Inc. for any damages resulting from such improper use or sale.
- Since Panjit uses lot number as the tracking base, please provide the lot number for tracking when complaining.

单击下面可查看定价，库存，交付和生命周期等信息

[>>Panjit\(强茂\)](#)