



PJA3461

60V P-Channel Enhancement Mode MOSFET

Voltage **-60 V** **Current** **-1.9A**

Features

- $R_{DS(ON)}$, $V_{GS}@-10V$, $I_D@-1.9A < 190m\Omega$
- $R_{DS(ON)}$, $V_{GS}@-4.5V$, $I_D@-1.5A < 240m\Omega$
- Advanced Trench Process Technology
- Specially Designed for Switch Load, PWM Application, etc
- Lead free in compliance with EU RoHS 2011/65/EU directive.
- Green molding compound as per IEC61249 Std. (Halogen Free)

Mechanical Data

- Case: SOT-23 Package
- Terminals : Solderable per MIL-STD-750, Method 2026
- Approx. Weight: 0.0003 ounces, 0.0084 grams
- Marking: A61

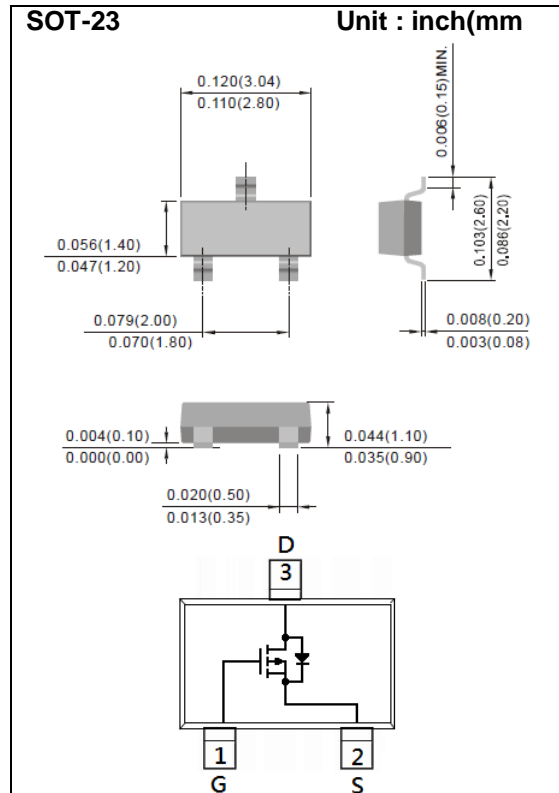

Maximum Ratings and Thermal Characteristics ($T_A=25^\circ C$ unless otherwise noted)

PARAMETER		SYMBOL	LIMIT	UNITS
Drain-Source Voltage		V_{DS}	-60	V
Gate-Source Voltage		V_{GS}	± 20	V
Continuous Drain Current	$T_A=25^\circ C$	I_D	-1.9	A
	$T_A=70^\circ C$		-1.5	
Pulsed Drain Current ^(Note 1)		I_{DM}	-7.6	A
Power Dissipation	$T_A=25^\circ C$	P_D	1.25	W
	$T_A=70^\circ C$		0.8	
Single Pulse Avalanche Energy ^(Note 5)		E_{AS}	32	mJ
Operating Junction and Storage Temperature Range		T_J, T_{STG}	-55~150	$^\circ C$
Typical Thermal resistance		$R_{\theta JA}$	100	$^\circ C/W$
- Junction to Ambient ^(Note 6)				



PJA3461

Electrical Characteristics ($T_A=25^\circ\text{C}$ unless otherwise noted)

PARAMETER	SYMBOL	TEST CONDITION	MIN.	TYP.	MAX.	UNITS
Static						
Drain-Source Breakdown Voltage	BV_{DSS}	$V_{GS}=0V, I_D=-250\mu A$	-60	-	-	V
Gate Threshold Voltage	$V_{GS(th)}$	$V_{DS}=V_{GS}, I_D=-250\mu A$	-1.0	-1.88	-2.5	V
Drain-Source On-State Resistance	$R_{DS(on)}$	$V_{GS}=-10V, I_D=-1.9A$	-	140	190	m Ω
		$V_{GS}=-4.5V, I_D=-1.5A$	-	190	240	
Zero Gate Voltage Drain Current	I_{DSS}	$V_{DS}=-60V, V_{GS}=0V$	-	-	-1	μA
Gate-Source Leakage Current	I_{GSS}	$V_{GS}=\pm 20V, V_{DS}=0V$	-	-	± 100	nA
Dynamic (Note 7)						
Total Gate Charge	Q_g	$V_{DS}=-30V, I_D=-1.9A,$ $V_{GS}=-10V$ (Note 1,2)	-	8.3	-	nC
Gate-Source Charge	Q_{gs}		-	1.8	-	
Gate-Drain Charge	Q_{gd}		-	1.6	-	
Input Capacitance	C_{iss}	$V_{DS}=-30V, V_{GS}=0V,$ $f=1.0\text{MHz}$	-	430	-	pF
Output Capacitance	C_{oss}		-	33	-	
Reverse Transfer Capacitance	C_{rss}		-	29	-	
Turn-On Delay Time	$t_{d(on)}$	$V_{DD}=-30V, I_D=-1.0A,$ $V_{GS}=-10V,$ $R_G=6\Omega$ (Note 1,2)	-	5.1	-	ns
Turn-On Rise Time	t_r		-	20	-	
Turn-Off Delay Time	$t_{d(off)}$		-	36	-	
Turn-Off Fall Time	t_f		-	11	-	
Drain-Source Diode						
Maximum Continuous Drain-Source Diode Forward Current	I_S	---	-	-	-1.5	A
Diode Forward Voltage	V_{SD}	$I_S=-1.0A, V_{GS}=0V$	-	-0.78	-1.0	V

NOTES :

1. Pulse width $\leq 300\mu s$, Duty cycle $\leq 2\%$
2. Essentially independent of operating temperature typical characteristics.
3. The maximum current rating is package limited.
4. Repetitive rating, pulse width limited by junction temperature $T_J(\text{MAX})=150^\circ\text{C}$. Ratings are based on low frequency and duty cycles to keep initial $T_J=25^\circ\text{C}$.
5. The test condition is $L=1\text{mH}, I_{AS}=8A, V_{DD}=25V, V_{GS}=10V$
6. $R_{\theta JA}$ is the sum of the junction-to-case and case-to-ambient thermal resistance where the case thermal reference is defined as the solder mounting surface of the drain pins. Mounted on a 1 inch² with 2oz.square pad of copper.
7. Guaranteed by design, not subject to production testing.



PJA3461

TYPICAL CHARACTERISTIC CURVES

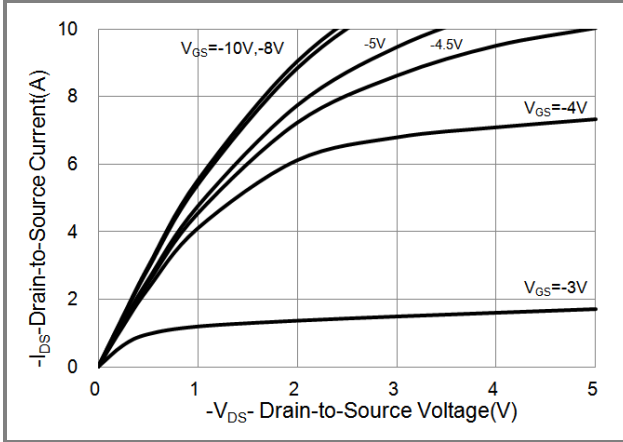

Fig.1 On-Region Characteristics

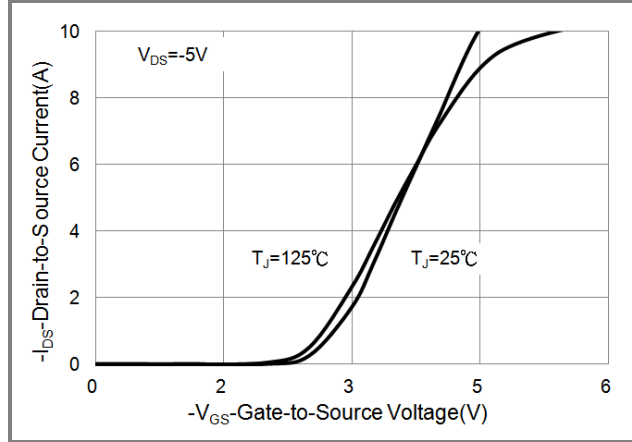

Fig.2 Transfer Characteristics

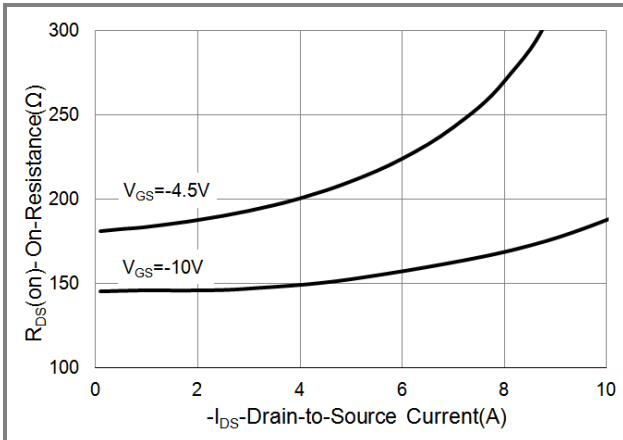

Fig.3 On-Resistance vs. Drain Current

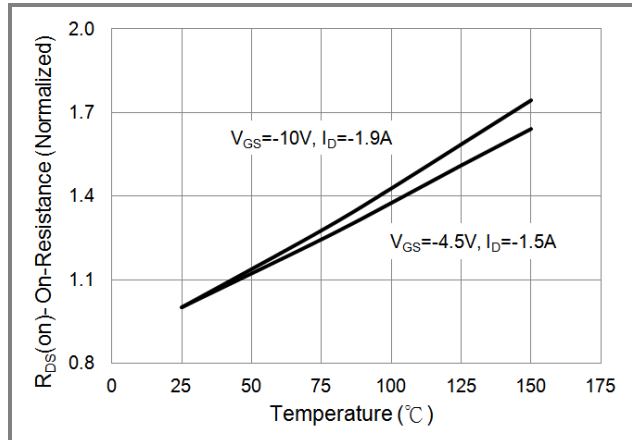

Fig.4 On-Resistance vs. Junction temperature

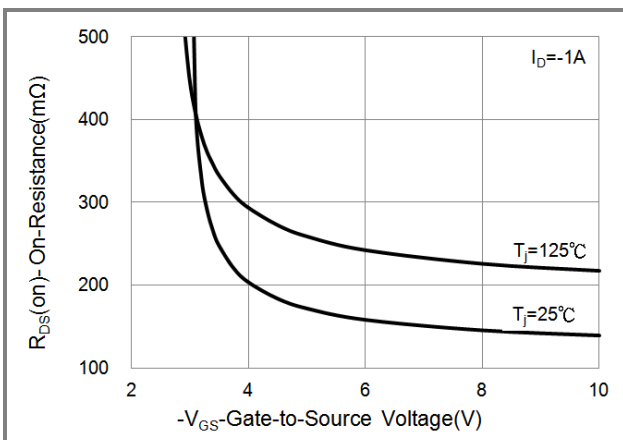

Fig.5 On-Resistance Variation with VGS.

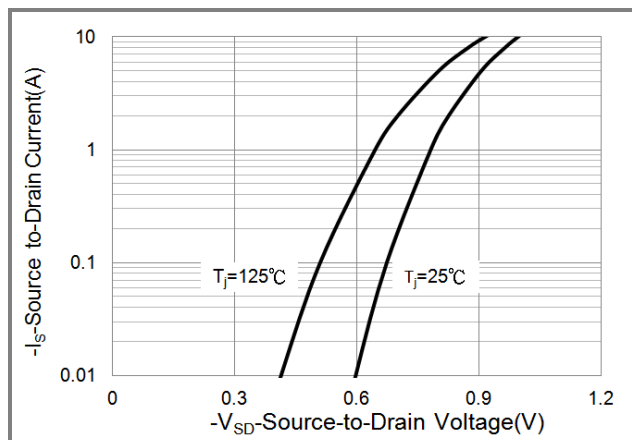

Fig.6 Body Diode Characteristics



PJA3461

TYPICAL CHARACTERISTIC CURVES

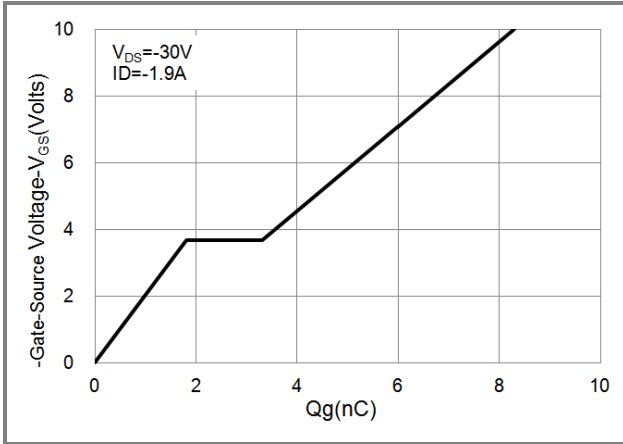

Fig.7 Gate-Charge Characteristics

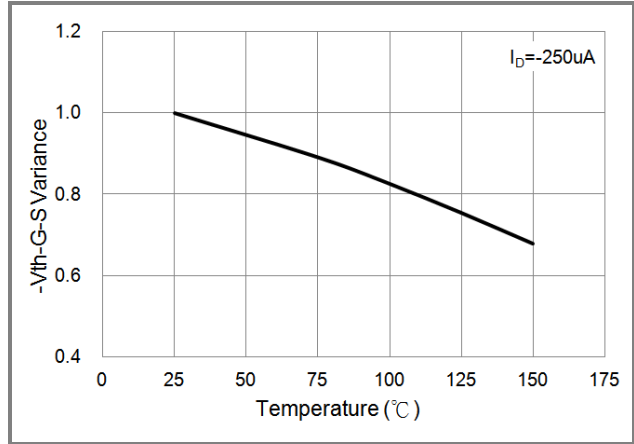

Fig.8 Threshold Voltage Variation with Temperature.

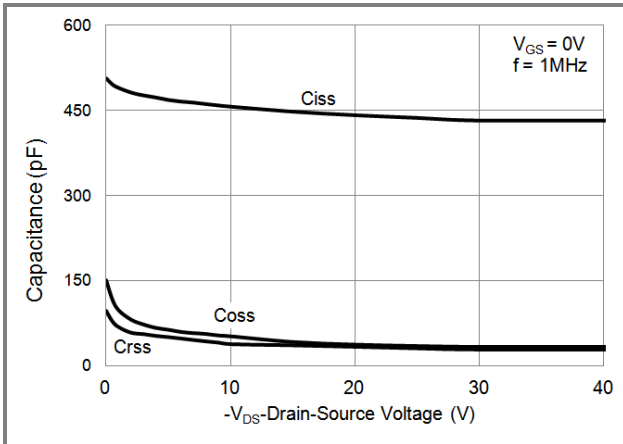

Fig.9 Capacitance vs. Drain-Source Voltage.

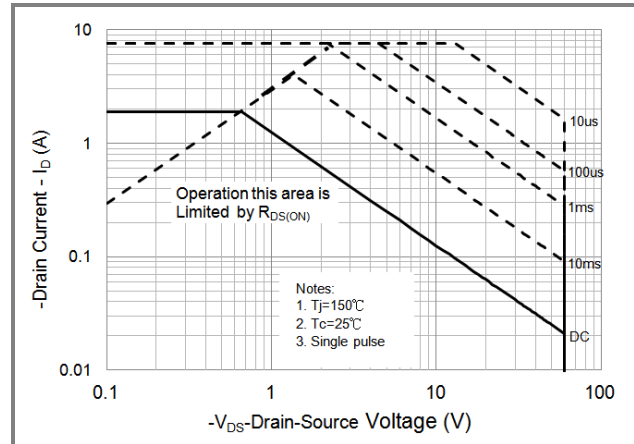

Fig.10 Maximum Safe Operating Area.

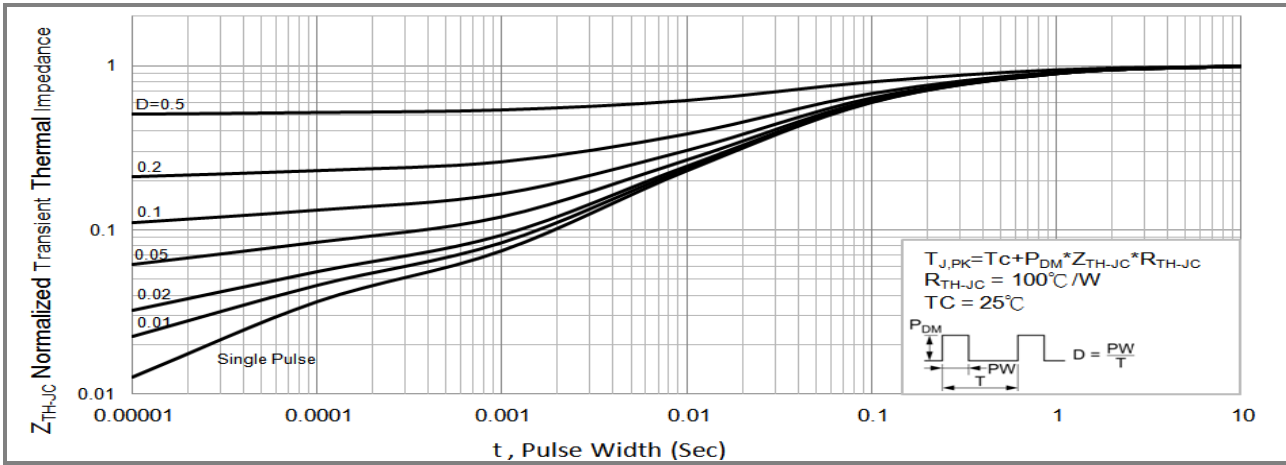

Fig.11 Normalized Transient Thermal Impedance vs. Pulse Width



PJA3461

PART NO PACKING CODE VERSION

Part No Packing Code	Package Type	Packing type	Marking	Version
PJA3461_R1_00001	SOT-23	3K pcs / 7" reel	A61	Halogen free
PJA3461_R2_00001	SOT-23	12K pcs / 13" reel	A61	Halogen free

MOUNTING PAD LAYOUT

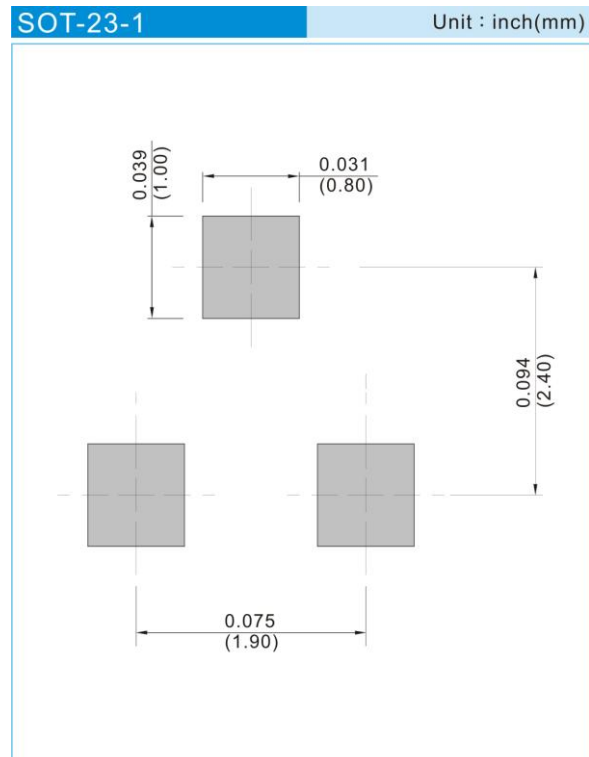



PJA3461

Disclaimer

- Reproducing and modifying information of the document is prohibited without permission from Panjit International Inc..
- Panjit International Inc. reserves the rights to make changes of the content herein the document anytime without notification. Please refer to our website for the latest document.
- Panjit International Inc. disclaims any and all liability arising out of the application or use of any product including damages incidentally and consequentially occurred.
- Panjit International Inc. does not assume any and all implied warranties, including warranties of fitness for particular purpose, non-infringement and merchantability.
- Applications shown on the herein document are examples of standard use and operation. Customers are responsible in comprehending the suitable use in particular applications. Panjit International Inc. makes no representation or warranty that such applications will be suitable for the specified use without further testing or modification.
- The products shown herein are not designed and authorized for equipments requiring high level of reliability or relating to human life and for any applications concerning life-saving or life-sustaining, such as medical instruments, transportation equipment, aerospace machinery et cetera. Customers using or selling these products for use in such applications do so at their own risk and agree to fully indemnify Panjit International Inc. for any damages resulting from such improper use or sale.
- Since Panjit uses lot number as the tracking base, please provide the lot number for tracking when complaining.

单击下面可查看定价，库存，交付和生命周期等信息

[>>Panjit\(强茂\)](#)