



SB120~SB160

SCHOTTKY BARRIER RECTIFIERS

VOLTAGE 20 to 60 Volt **CURRENT** 1.0 Ampere

DO-41 Unit : inch(mm)

FEATURES

- Plastic package has Underwriters Laboratory Flammability Classification 94V-O utilizing Flame Retardant Epoxy Molding Compound.
- For use in low voltage,high frequency inverters ,free wheeling , and polarity protection applications .
- Lead free in compliance with EU RoHS 2.0

MECHANICAL DATA

- Case: DO-41 Molded plastic
- Terminals: Axial leads, solderable per MIL-STD-750,Method 2026
- Polarity: Color band denotes cathode
- Weight: 0.0118 ounces, 0.336 grams

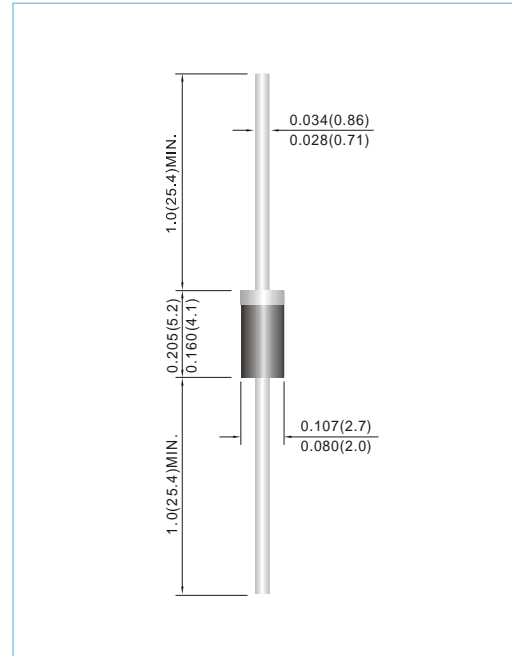

MAXIMUM RATINGS AND ELECTRICAL CHARACTERISTICS

Ratings at 25°C ambient temperature unless otherwise specified. Single phase, half wave, 60 Hz, resistive or inductive load.

PARAMETER	SYMBOL	SB120	SB130	SB140	SB150	SB160	UNITS
Maximum Recurrent Peak Reverse Voltage	V_{RRM}	20	30	40	50	60	V
Maximum RMS Voltage	V_{RMS}	14	21	28	35	42	V
Maximum DC Blocking Voltage	V_{DC}	20	30	40	50	60	V
Maximum Average Forward Rectified Current 0.375"(9.5mm) lead length (See Figure1)	$I_{F(AV)}$	1.0					A
Peak Forward Surge Current : 8.3ms single half sine-wave superimposed on rated load	I_{FSM}	30					A
Maximum Forward Voltage at 1.0A	V_F	0.5			0.7		V
Maximum DC Reverse Current at Rated DC Blocking Voltage $T_J=25^{\circ}C$ $T_J=100^{\circ}C$	I_R	0.2 10			0.1 10		mA
Typical Thermal Resistance	$R_{\theta JA}$	50					°C / W
Operating Junction and Storage Temperature Range	T_J, T_{STG}	-55 to +125			-55 to +150		°C



SB120~SB160

RATING AND CHARACTERISTIC CURVES

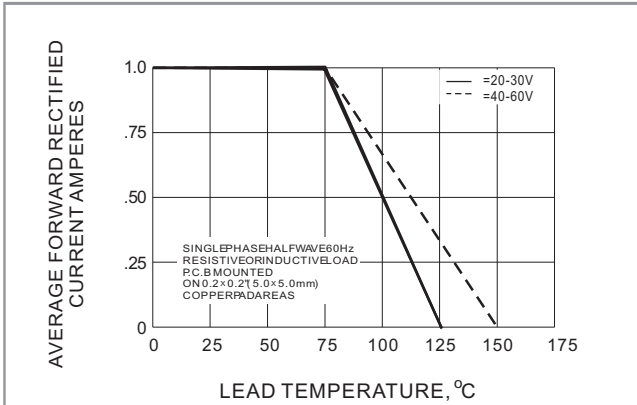

Fig.1 FORWARD CURRENT DERATING CURVE

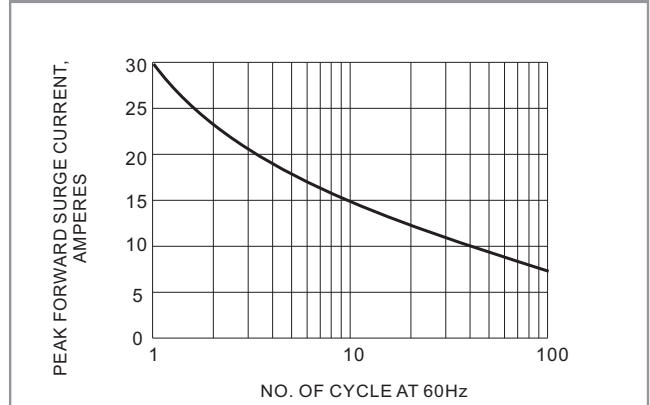

Fig.2 MAXIMUM NON-REPETITIVE PEAK FORWARD SURGE CURRENT

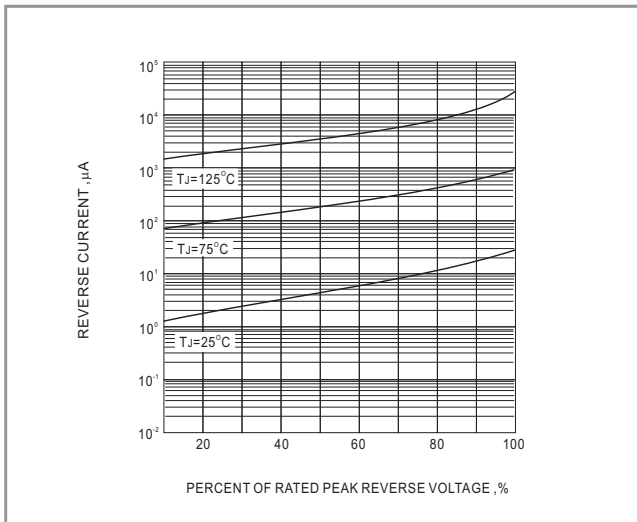

Fig.3 TYPICAL REVERSE CHARACTERISTIC

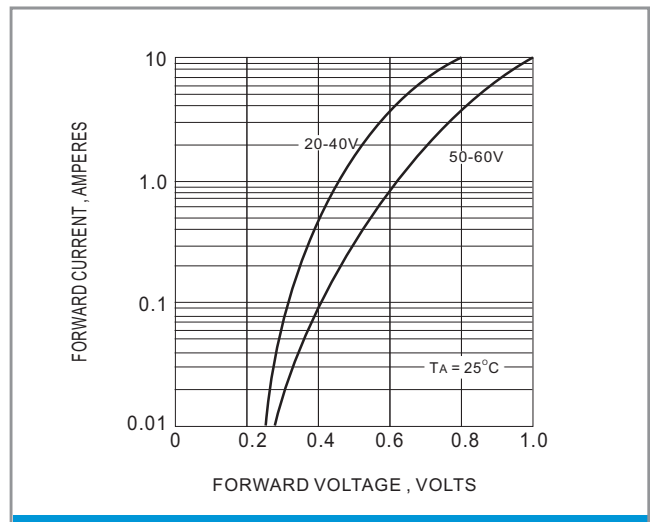

Fig.4 TYPICAL INSTANTANEOUS FORWARD CHARACTERISTIC

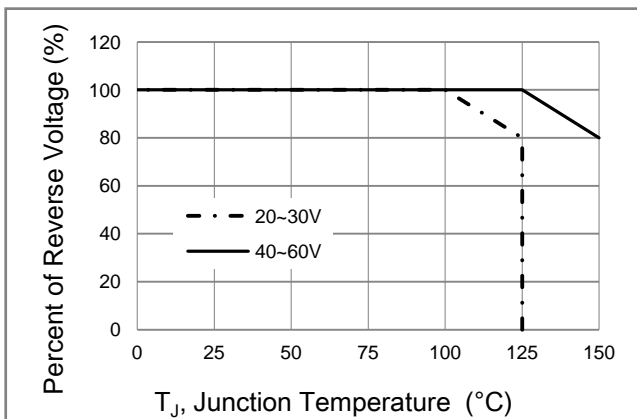

Fig.5 Operating Temperature Derating Curve



SB120~SB160

Part No_packing code_Version

- SB120_AY_00001
- SB120_AY_10001
- SB120_B0_00001
- SB120_B0_10001
- SB120_R2_00001
- SB120_R2_10001

For example :

RB500V-40_R2_00001

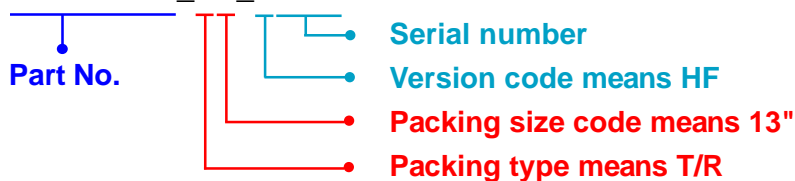

Packing Code XX				Version Code XXXXX		
Packing type	1 st Code	Packing size code	2 nd Code	HF or RoHS	1 st Code	2 nd ~5 th Code
Tape and Ammunition Box (T/B)	A	N/A	0	HF	0	serial number
Tape and Reel (T/R)	R	7"	1	RoHS	1	serial number
Bulk Packing (B/P)	B	13"	2			
Tube Packing (T/P)	T	26mm	X			
Tape and Reel (Right Oriented) (TRR)	S	52mm	Y			
Tape and Reel (Left Oriented) (TRL)	L	PANASERT T/B CATHODE UP (PBCU)	U			
FORMING	F	PANASERT T/B CATHODE DOWN (PBCD)	D			



SB120~SB160

Disclaimer

- Reproducing and modifying information of the document is prohibited without permission from Panjit International Inc..
- Panjit International Inc. reserves the rights to make changes of the content herein the document anytime without notification. Please refer to our website for the latest document.
- Panjit International Inc. disclaims any and all liability arising out of the application or use of any product including damages incidentally and consequentially occurred.
- Panjit International Inc. does not assume any and all implied warranties, including warranties of fitness for particular purpose, non-infringement and merchantability.
- Applications shown on the herein document are examples of standard use and operation. Customers are responsible in comprehending the suitable use in particular applications. Panjit International Inc. makes no representation or warranty that such applications will be suitable for the specified use without further testing or modification.
- The products shown herein are not designed and authorized for equipments requiring high level of reliability or relating to human life and for any applications concerning life-saving or life-sustaining, such as medical instruments, transportation equipment, aerospace machinery et cetera. Customers using or selling these products for use in such applications do so at their own risk and agree to fully indemnify Panjit International Inc. for any damages resulting from such improper use or sale.
- Since Panjit uses lot number as the tracking base, please provide the lot number for tracking when complaining.

单击下面可查看定价，库存，交付和生命周期等信息

[>>Panjit\(强茂\)](#)