



# SB560L

## LOW VF SCHOTTKY BARRIER RECTIFIERS

**VOLTAGE** 60 Volt **CURRENT** 5 Ampere

**DO-201AD** Unit : inch(mm)

### FEATURES

- Plastic package has Underwriters Laboratory Flammability Classification 94V-O utilizing Flame Retardant Epoxy Molding Compound.
- For use in low voltage, high frequency inverters, free wheeling, and polarity protection applications.
- Lead free in compliance with EU RoHS 2011/65/EU directive
- Green molding compound as per IEC61249 Std. . (Halogen Free)

### MECHANICAL DATA

- Case: DO-201AD Molded plastic
- Terminals: Axial leads, solderable per MIL-STD-750, Method 2026
- Polarity: Color band denotes cathode
- Weight: 0.04 ounces, 1.142 grams

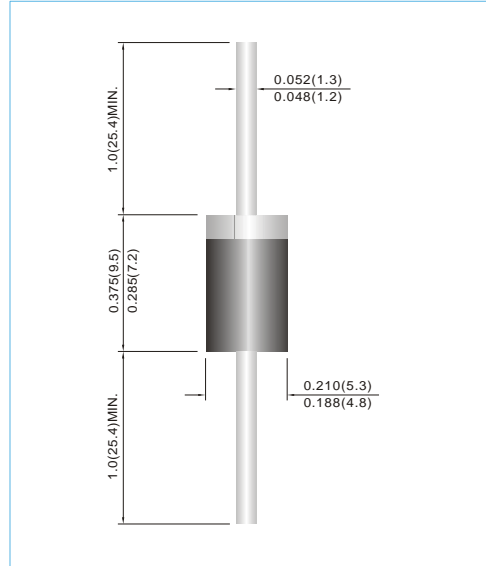

## MAXIMUM RATINGS AND ELECTRICAL CHARACTERISTICS

Ratings at 25°C ambient temperature unless otherwise specified. Single phase, half wave, 60 Hz, resistive or inductive load.

PARAMETER	SYMBOL	VALUE	UNITS
Maximum Recurrent Peak Reverse Voltage	$V_{RRM}$	60	V
Maximum RMS Voltage	$V_{RMS}$	42	V
Maximum DC Blocking Voltage	$V_{DC}$	60	V
Maximum Average Forward Rectified Current (See Fig 3)	$I_{F(AV)}$	5	A
Peak Forward Surge Current : 8.3ms single half sine-wave superimposed on rated load	$I_{FSM}$	150	A
Maximum Forward Voltage at 5A	$V_F$	0.49	V
Maximum DC Reverse Current at Rated DC Blocking Voltage $T_J=25^{\circ}C$ $T_J=100^{\circ}C$	$I_R$	0.5 50	mA
Typical Thermal Resistance (Note 1)	$R_{\theta JL}$	10	$^{\circ}C / W$
Operating Junction Temperature Range	$T_J$	-55 to +150	$^{\circ}C$
Storage Temperature Range	$T_{STG}$	-55 to +150	$^{\circ}C$

### NOTES :

1. Thermal Resistance Junction to Lead Vertical PC Board Mounting 0.375" (9.5mm) Lead Lengths.



**SB560L**

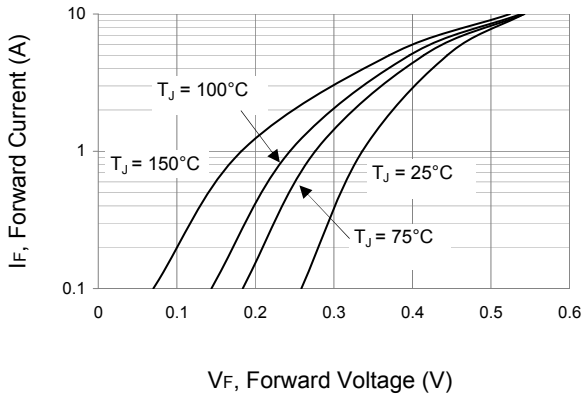

**Fig.1 Typical Forward Characteristics**

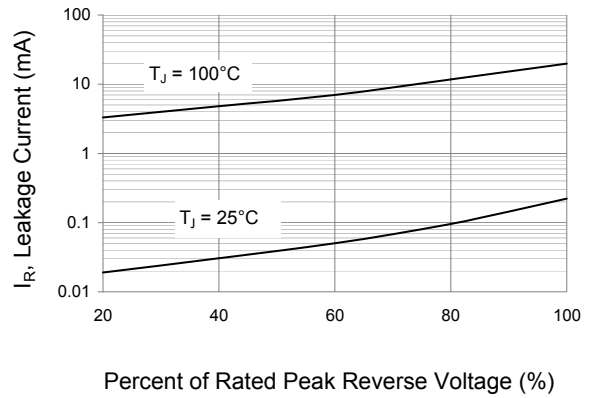

**Fig.2 Typical Reverse Characteristics**

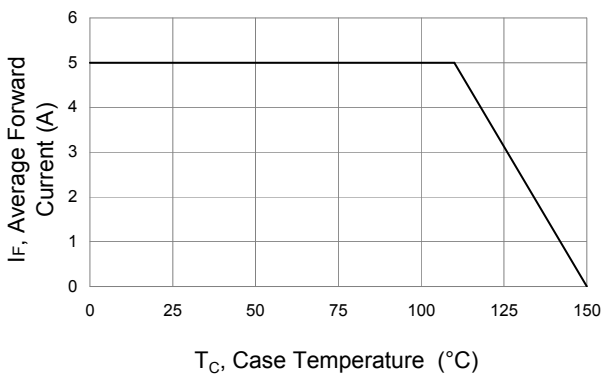

**Fig.3 Forward Current Derating Curve**

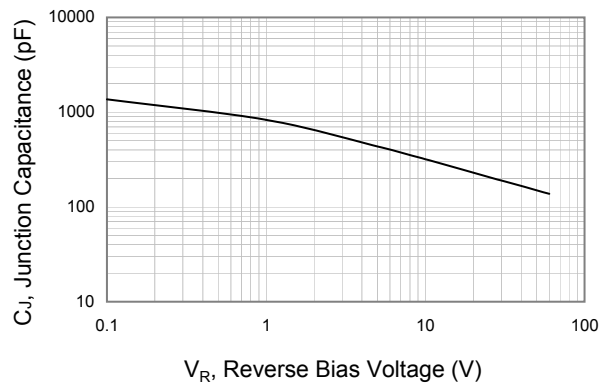

**Fig.4 Typical Junction Capacitance under Bias**

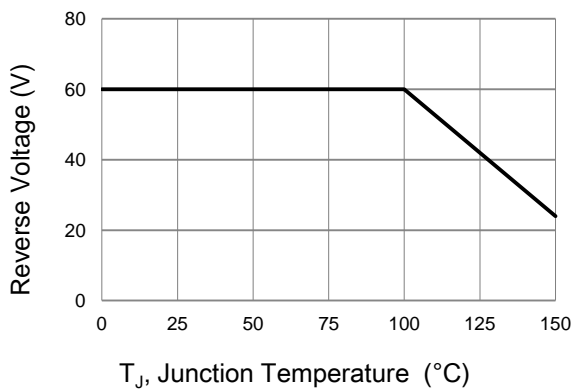

**Fig.5 Operating Temperature Derating Curve**



# SB560L

## PART NO PACKING CODE VERSION

Part No Packing Code	Package Type	Packing Type	Marking	Version
SB560L_AY_00001	DO-201AD	1.25K pcs / box	SB560L	Halogen free
SB560L_B0_00001	DO-201AD	500 pcs / box	SB560L	Halogen free
SB560L_R2_00001	DO-201AD	1.25K pcs / 13" reel	SB560L	Halogen free

For example :

**RB500V-40** **R2** **00001**

Part No.

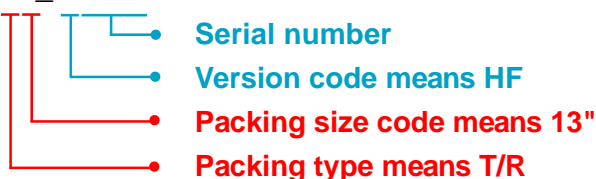

Packing Code <b>XX</b>				Version Code <b>XXXXX</b>		
Packing type	1 <sup>st</sup> Code	Packing size code	2 <sup>nd</sup> Code	HF or RoHS	1 <sup>st</sup> Code	2 <sup>nd</sup> ~5 <sup>th</sup> Code
Tape and Ammunition Box (T/B)	<b>A</b>	N/A	<b>0</b>	<b>HF</b>	<b>0</b>	serial number
Tape and Reel (T/R)	<b>R</b>	7"	<b>1</b>	<b>RoHS</b>	<b>1</b>	serial number
Bulk Packing (B/P)	<b>B</b>	13"	<b>2</b>			
Tube Packing (T/P)	<b>T</b>	26mm	<b>X</b>			
Tape and Reel (Right Oriented) (TRR)	<b>S</b>	52mm	<b>Y</b>			
Tape and Reel (Left Oriented) (TRL)	<b>L</b>	PANASERT T/B CATHODE UP (PBCU)	<b>U</b>			
FORMING	<b>F</b>	PANASERT T/B CATHODE DOWN (PBCD)	<b>D</b>			



## SB560L

---

### Disclaimer

- Reproducing and modifying information of the document is prohibited without permission from Panjit International Inc..
- Panjit International Inc. reserves the rights to make changes of the content herein the document anytime without notification. Please refer to our website for the latest document.
- Panjit International Inc. disclaims any and all liability arising out of the application or use of any product including damages incidentally and consequentially occurred.
- Panjit International Inc. does not assume any and all implied warranties, including warranties of fitness for particular purpose, non-infringement and merchantability.
- Applications shown on the herein document are examples of standard use and operation. Customers are responsible in comprehending the suitable use in particular applications. Panjit International Inc. makes no representation or warranty that such applications will be suitable for the specified use without further testing or modification.
- The products shown herein are not designed and authorized for equipments requiring high level of reliability or relating to human life and for any applications concerning life-saving or life-sustaining, such as medical instruments, transportation equipment, aerospace machinery et cetera. Customers using or selling these products for use in such applications do so at their own risk and agree to fully indemnify Panjit International Inc. for any damages resulting from such improper use or sale.
- Since Panjit uses lot number as the tracking base, please provide the lot number for tracking when complaining.

单击下面可查看定价，库存，交付和生命周期等信息

[>>Panjit\(强茂\)](#)