



SBT40100VCT

ULTRA LOW VF SCHOTTKY RECTIFIER

VOLTAGE 100 Volt **CURRENT** 40 Ampere

FEATURES

- Ultra Low forward voltage drop, low power loss
- High efficiency operation
- Lead free in compliance with EU RoHS 2011/65/EU directive
- Green molding compound as per IEC61249 Std. . (Halogen Free)

MECHANICAL DATA

- Case : TO-220AB, Plastic
- Terminals : Solderable per MIL-STD-750, Method 2026
- Weight: 0.067 ounces, 1.89 grams

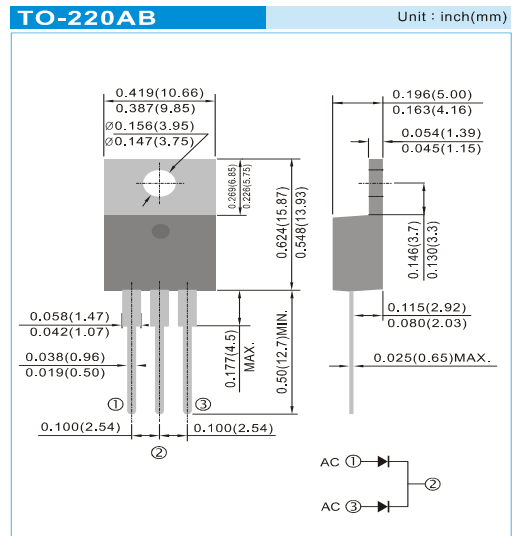

MAXIMUM RATINGS(T_A=25°C unless otherwise noted)

PARAMETER	SYMBOL	VALUE	UNIT
Maximum repetitive peak reverse voltage	V _{RRM}	100	V
Maximum rms voltage	V _{RMS}	70	V
Maximum dc blocking voltage	V _R	100	V
Maximum average forward rectified current	I _{F(AV)}	40 20	A
Peak forward surge current : 8.3ms single half sine-wave superimposed on rated load	I _{FSM}	250	A
Typical thermal resistance	R _{θJC}	2	°C/W
Operating junction temperature range	T _J	-55 to + 150	°C
Storage temperature range	T _{STG}	-55 to + 150	°C

Note : 1. Mounted on infinite heatsink.

ELECTRICAL CHARACTERISTICS(T_A=25°C unless otherwise noted)

PARAMETER	SYMBOL	TEST CONDITIONS	MIN.	TYP.	MAX.	UNIT
Breakdown voltage per diode	V _{BR}	I _R =0.5mA	100	-	-	V
Instantaneous forward voltage per diode	V _F	I _F =5A	-	0.48	-	V
		I _F =10A	-	0.57	-	V
		I _F =20A	-	0.71	0.76	V
		T _J =25°C	-	-	-	-
Reverse current per diode	I _R	I _F =5A	-	0.41	-	V
		I _F =10A	-	0.53	-	V
		I _F =20A	-	0.68	-	V
		T _J =125°C	-	-	-	-
Reverse current per diode	I _R	V _R =70V	-	5	-	μA
		V _R =100V	-	6	-	mA
Reverse current per diode	I _R	V _R =70V	-	-	120	μA
		T _J =25°C	-	-	-	mA
Reverse current per diode	I _R	T _J =125°C	-	12	-	mA
		T _J =125°C	-	-	-	-



SBT40100VCT

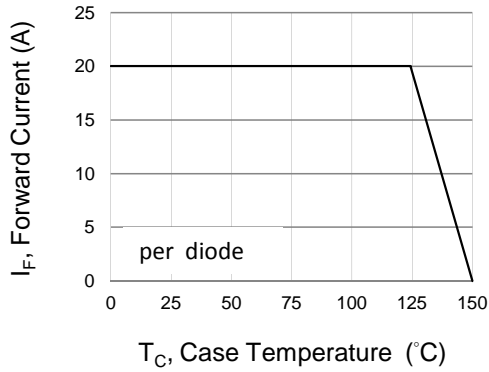

Fig.1 Forward Current Derating Curve

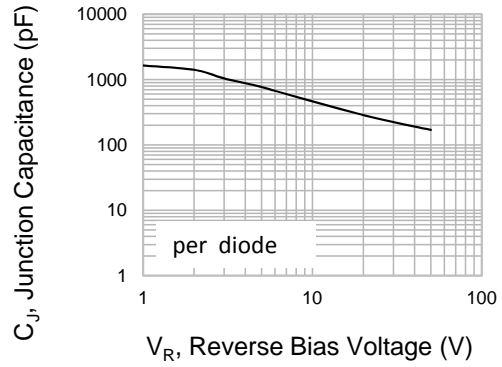

Fig.2 Typical Junction Capacitance

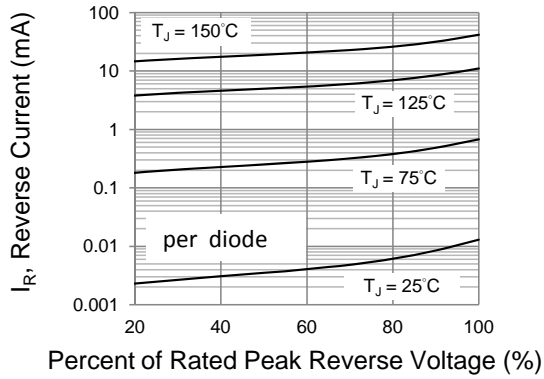

Fig.3 Typical Reverse Characteristics

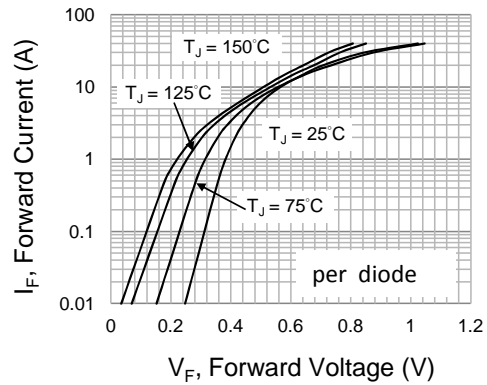

Fig.4 Typical Forward Characteristics

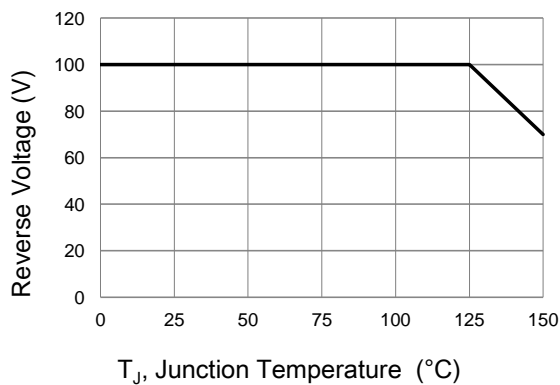

Fig.5 Operating Temperature Derating Curve



SBT40100VCT

Part No_packing code_Version

SBT40100VCT_T0_00001

For example :

RB500V-40_R2_00001

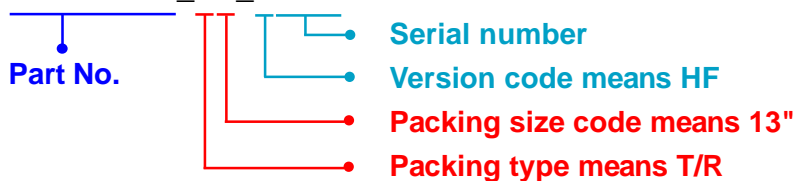

Packing Code XX				Version Code XXXXX		
Packing type	1 st Code	Packing size code	2 nd Code	HF or RoHS	1 st Code	2 nd ~5 th Code
Tape and Ammunition Box (T/B)	A	N/A	0	HF	0	serial number
Tape and Reel (T/R)	R	7"	1	RoHS	1	serial number
Bulk Packing (B/P)	B	13"	2			
Tube Packing (T/P)	T	26mm	X			
Tape and Reel (Right Oriented) (TRR)	S	52mm	Y			
Tape and Reel (Left Oriented) (TRL)	L	PANASERT T/B CATHODE UP (PBCU)	U			
FORMING	F	PANASERT T/B CATHODE DOWN (PBCD)	D			



SBT40100VCT

Disclaimer

- Reproducing and modifying information of the document is prohibited without permission from Panjit International Inc..
- Panjit International Inc. reserves the rights to make changes of the content herein the document anytime without notification. Please refer to our website for the latest document.
- Panjit International Inc. disclaims any and all liability arising out of the application or use of any product including damages incidentally and consequentially occurred.
- Panjit International Inc. does not assume any and all implied warranties, including warranties of fitness for particular purpose, non-infringement and merchantability.
- Applications shown on the herein document are examples of standard use and operation. Customers are responsible in comprehending the suitable use in particular applications. Panjit International Inc. makes no representation or warranty that such applications will be suitable for the specified use without further testing or modification.
- The products shown herein are not designed and authorized for equipments requiring high level of reliability or relating to human life and for any applications concerning life-saving or life-sustaining, such as medical instruments, transportation equipment, aerospace machinery et cetera. Customers using or selling these products for use in such applications do so at their own risk and agree to fully indemnify Panjit International Inc. for any damages resulting from such improper use or sale.
- Since Panjit uses lot number as the tracking base, please provide the lot number for tracking when complaining.

单击下面可查看定价，库存，交付和生命周期等信息

[>>Panjit\(强茂\)](#)