

Network cable - NBC- 5,0-94L/M12FR - 1192114

Please be informed that the data shown in this PDF Document is generated from our Online Catalog. Please find the complete data in the user's documentation. Our General Terms of Use for Downloads are valid (<http://phoenixcontact.com/download>)

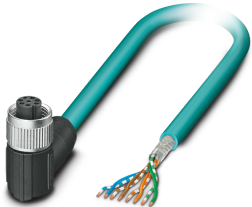

Network cable, Ethernet CAT5e (1 Gbps), 8-position, TPE, Teal, free cable end, on Socket angled M12 / IP65, coding: A, cable length: 5 m



Key Commercial Data

Packing unit	1 pc
GTIN	 4 063151 325091
GTIN	4063151325091
Country of origin	United States

Technical data

Dimensions

Length of cable	5 m
-----------------	-----

Ambient conditions

Degree of protection	IP65
Ambient temperature (operation)	-25 °C ... 85 °C (M12 connector)

General data

Rated current at 40°C	2 A (Plug/socket in accordance with IEC 61076-2-101, cable technical data is to be observed)
Rated voltage	48 V AC
	60 V DC
Number of positions	8
Signal type/category	Ethernet CAT5e, 1 Gbps
Standards/regulations	M12 connector IEC 61076-2-101

Network cable - NBC- 5,0-94L/M12FR - 1192114

Technical data

General data

Contact material	CuSn
Contact carrier material	TPU GF
Contact surface material	Ni/Au
Transmission characteristics (category)	CAT5e
Transmission speed	1 Gbps

Characteristics head 1

Head type	free cable end
-----------	----------------

Characteristics head 2

Head type	Socket angled M12 / IP65
Coding	A (Standard)

Standards and Regulations

Standards/specifications	M12 connector IEC 61076-2-101
--------------------------	-------------------------------

Cable

Cable type (abbreviation)	94L
UL AWM style	2463 (80 °C / 600 V)
Signal type/category	Ethernet CAT5e (TIA 568B)
Cable structure	4x2xAWG24/7; SF/UTP
Conductor cross section	4x 2x 0.2 mm ²
AWG signal line	24
Conductor structure signal line	7x 0.20 mm (7x32)
Core diameter including insulation	1.2 mm
Wire colors	white/blue-blue, white/orange-orange, white/green-green, white/brown-brown
Twisted pairs	2 cores to the pair
Overall twist	4 pairs for core
Shielding	Aluminum-lined polyester foil, tinned copper braided shield
Optical shield covering	75 %
External sheath, color	Teal
External cable diameter D	7.4 mm ±0.25 mm
Number of bending cycles	1000000
Minimum bending radius, drag chain applications	10 x D
Number of bending cycles	10000000
Minimum bending radius, drag chain applications	20 X D
Torsion force	1 lb. load
Torsion cycles	4800000
Torsional frequency	71 (cycles/min)

Network cable - NBC- 5,0-94L/M12FR - 1192114

Technical data

Cable

Ambient temperature (operation)	20 °C
Outer sheath, material	TPE
Material conductor insulation	PE
Conductor material	Tin-plated Cu litz wires
Wave impedance	100 Ω ±15 Ω (at 100 MHz)
Near end crosstalk attenuation (NEXT)	50 dB (with 100 MHz (IEC 62153-4-9))
Return loss (RL)	20 dB (at 10 MHz (+6LOG))
	26 dB (at 20 MHz)
	26 dB (at 100 MHz (-5LOG))
Cable impedance	100 Ω ±15 Ω (at 1 ... 100 MHz)
Nominal voltage, cable	600 V
Test voltage, cable	2000 V
Flame resistance	VW-1
Other resistance	Resistant to welding splashes Abrasion and oil resistance
	UV resistant CMX outdoor
Ambient temperature (operation)	-40 °C ... 80 °C (Cable, flexible installation)
Shielded	yes

Drawings

Schematic diagram

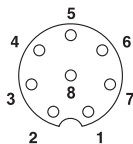

Pin assignment M12 socket, 8-pos., A-coded, view female side

Circuit diagram

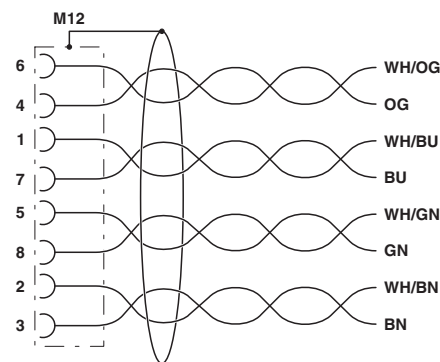

Contact assignment of the M12 socket

Network cable - NBC- 5,0-94L/M12FR - 1192114

Dimensional drawing

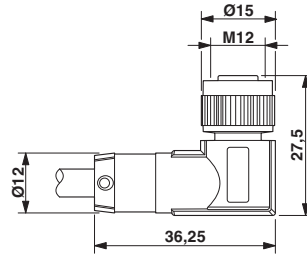

M12 x 1 socket, angled, shielded

Cable cross section



Network cable - NBC- 5,0-94L/M12FR - 1192114

Classifications

eCl@ss

eCl@ss 9.0	27060308
eCl@ss 11.0	27060307

Approvals

Approvals

Approvals

UL Recognized / cUL Recognized / cULus Recognized

Ex Approvals

Approval details

UL Recognized		http://database.ul.com/cgi-bin/XYV/template/LISEXT/1FRAME/index.htm	File E335024
Nominal voltage UN		60 V	
Nominal current IN		1.5 A	

cUL Recognized		http://database.ul.com/cgi-bin/XYV/template/LISEXT/1FRAME/index.htm	File E335024
Nominal voltage UN		60 V	
Nominal current IN		1.5 A	

cULus Recognized	
------------------	---

单击下面可查看定价，库存，交付和生命周期等信息

[>>Phoenix Contact\(菲尼克斯\)](#)