

Bus system cable - SAC-5P-MINMR/ 2,0-928/MINFR DN - 1417922

Please be informed that the data shown in this PDF Document is generated from our Online Catalog. Please find the complete data in the user's documentation. Our General Terms of Use for Downloads are valid (<http://download.phoenixcontact.com>)



Bus system cable, DeviceNet, 5-position, PVC, Gray RAL 7001, Plug angled 7/8"-16UNF, on Socket angled 7/8"-16UNF, Cable length: 2 m



Key commercial data

Packing unit	0
Minimum order quantity	1
Catalog page	Page 399 (PC-2011)
GTIN	 4 046356 540247
Custom tariff number	85444290
Country of origin	GERMANY

Technical data

General data

Rated current at 40°C	5.2 A
Rated voltage	30 V
Number of positions	5
Volume resistance	< 5 mΩ
Length of cable	2 m

General characteristics

Coding	A - standard
Surge voltage category	II
Pollution degree	3
Degree of protection	IP65/IP67/IP69K
Contact material	CuZn
Contact surface material	Au
Contact carrier material	PA 66
Material of grip body	TPU
Material, knurls	High-grade steel
Sealing material	TPU
Status display	No

Bus system cable - SAC-5P-MINMR/ 2,0-928/MINFR DN - 1417922

Technical data

Conductor data

AWG signal line	18
AWG power supply	15
Wire colors	Red-black, blue-white
Shielding	Tinned copper braided shield
External sheath, color	Gray RAL 7001
External cable diameter D	12.2 mm
Smallest bending radius, fixed installation	61 mm
Smallest bending radius, movable installation	122 mm
Outer sheath, material	PVC
Conductor material	Tin-plated Cu litz wires
Wave impedance	120 Ω +/-10% (Data pair)

Classifications

eclass

eCl@ss 4.0	27060307
eCl@ss 4.1	27060307
eCl@ss 5.0	27061801
eCl@ss 5.1	27060307
eCl@ss 6.0	27061801
eCl@ss 7.0	27061801

etim

ETIM 2.0	EC000830
ETIM 3.0	EC000830
ETIM 4.0	EC001855

unspsc

UNSPSC 6.01	26121616
UNSPSC 7.0901	26121616
UNSPSC 11	26121604
UNSPSC 12.01	26121616
UNSPSC 13.2	26121616

Drawings

Schematic diagram

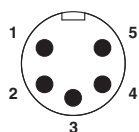

Connector pin assignment for 7/8"-16UNF conn., 5-pos.

Schematic diagram

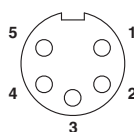

Pin assignment, socket, 7/8"-16UNF, 5-pos., view of female side

Bus system cable - SAC-5P-MINMR/ 2,0-928/MINFR DN - 1417922

Dimensioned drawing

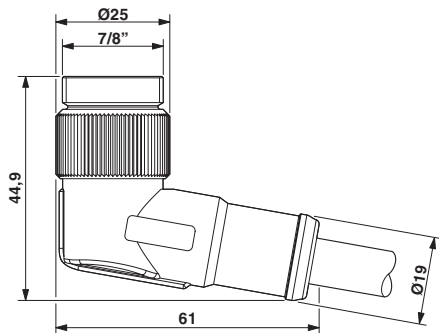

7/8"-16UNF connector, angled

Circuit diagram

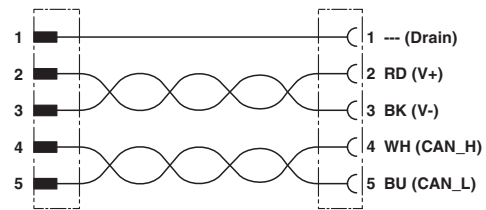

Contact assignment of the 7/8" connector and the 7/8" socket

单击下面可查看定价，库存，交付和生命周期等信息

[>>Phoenix Contact\(菲尼克斯\)](#)