

Pin strip - PST 1,0/ 4-3,5 R24 - 1995525

Please be informed that the data shown in this PDF Document is generated from our Online Catalog. Please find the complete data in the user's documentation. Our General Terms of Use for Downloads are valid (<http://phoenixcontact.com/download>)



Header, Nominal current: 6 A, Rated voltage (III/2): 250 V, Number of positions: 4, Pitch: 3.5 mm, Color: black, Contact surface: Tin, Assembly: Taped SMD/THT/THR components, Voltage and current depend on the plug-in terminal block used.

Product Features

- Various pin lengths and pin geometries available on request
- Pin strip with pad pushed on for suction pipette for optional tape-on-reel packing
- 3.5 mm pitch
- Optimum pin geometry so as to not damage the plug
- Pin strip available in machine-capable packaging (tube magazine or tape)
- Reflow solderable pin strip, optimized for COMBICON compact connectors



Key commercial data

Packing unit	1 pc
Minimum order quantity	330 pc
Weight per Piece (excluding packing)	1.65 GRM
Custom tariff number	85366990
Country of origin	Germany

Technical data

Dimensions

Length	2.8 mm
Pitch	3.5 mm
Dimension a	10.5 mm
Pin dimensions	1 mm
Pin spacing	3.50 mm
Hole diameter	1.2 mm

General

Pin strip - PST 1,0/ 4-3,5 R24 - 1995525

Technical data

General

Range of articles	PST 1,0/...-V
Insulating material group	IIIa
Rated surge voltage (III/3)	2.5 kV
Rated surge voltage (III/2)	2.5 kV
Rated surge voltage (II/2)	2.5 kV
Rated voltage (III/3)	160 V
Rated voltage (III/2)	250 V
Rated voltage (II/2)	250 V
Connection in acc. with standard	EN-VDE
Nominal current I _N	6 A (depends on the plug used)
Maximum load current	6 A (depends on the plug used)
Insulating material	PA
Inflammability class according to UL 94	V0
Color	black
Number of positions	4

Classifications

eCl@ss

eCl@ss 4.0	272607xx
eCl@ss 4.1	27260701
eCl@ss 5.0	27260701
eCl@ss 5.1	27260701
eCl@ss 6.0	27260704
eCl@ss 7.0	27440402
eCl@ss 8.0	27440402

ETIM

ETIM 3.0	EC001121
ETIM 4.0	EC002637
ETIM 5.0	EC002637

UNSPSC

UNSPSC 6.01	30211801
UNSPSC 7.0901	39121432
UNSPSC 11	34131203
UNSPSC 12.01	39121432
UNSPSC 13.2	39121432

Pin strip - PST 1,0/ 4-3,5 R24 - 1995525

Approvals

Approvals

Approvals

UL Recognized / cUL Recognized / GOST / GOST / SEV / cULus Recognized

Ex Approvals

Approvals submitted

Approval details

UL Recognized 	
	B
Nominal current IN	10 A
Nominal voltage UN	300 V

cUL Recognized 	
	B
Nominal current IN	10 A
Nominal voltage UN	300 V

GOST 	
--	--

GOST 	
--	--

SEV	
mm ² /AWG/kcmil	0.5

Pin strip - PST 1,0/ 4-3,5 R24 - 1995525

Approvals

Nominal current I _N	4 A
Nominal voltage U _N	160 V

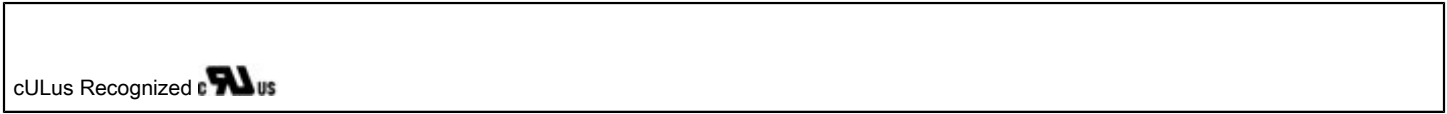

Drawings

Drilling diagram

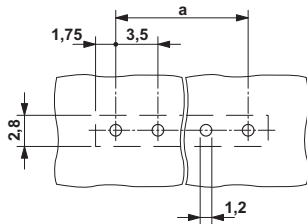

Dimensioned drawing

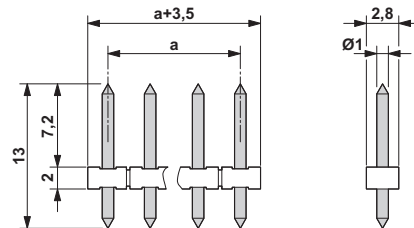

Dimensioned drawing

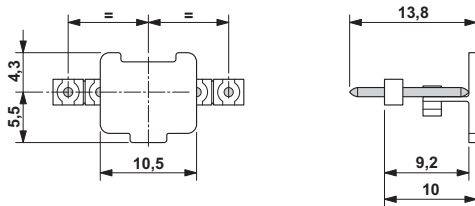

Dimensioned drawing

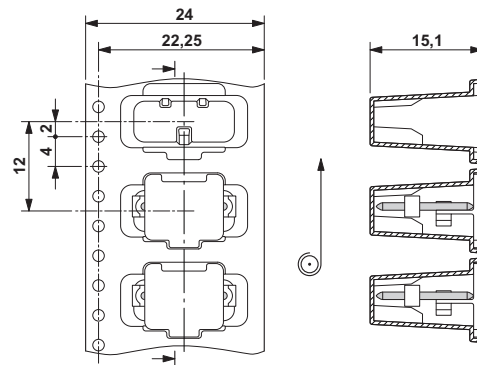

单击下面可查看定价，库存，交付和生命周期等信息

[>>Phoenix Contact \(菲尼克斯\)](#)