

Data sheet

Order No.: 1156838

Type: FQ 1,27D/ 30-SV- 490-1-BR

SMD socket, Reflow soldering

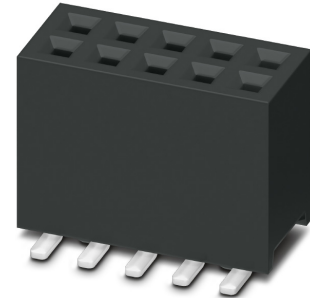

The figure shows the 10-pos. version

1 Main features



• No. of pos.	30	• Nominal current	1 A
• Test voltage	500 V AC	• Mounting type	SMD soldering
• Color	black (9005)	• Connection direction	90 °
• Pitch	1.27 mm	• Type of packaging	32 mm wide tape

2 Your advantages

- ✓ Reliable mechanical and electrical connections thanks to the double-sided contact system
- ✓ Designed for integration into the SMT soldering process
- ✓ Clear and cost-optimized design
- ✓ Suitable for a multitude of applications



Make sure you always use the latest documentation.

It can be downloaded at: phoenixcontact.net/product/1156838

3 Table of contents

1	Main features.....	1
2	Your advantages	1
3	Table of contents	2
4	General Technical Data	3
5	Mounting.....	4
6	Dimensions.....	5
7	Series drawing.....	6
8	Product notes	7
9	Packaging information	7
10	Blister drawing.....	8
11	Application.....	9
12	General tests	10
13	Mechanical tests.....	11
14	Electrical tests	12
15	Current carrying capacity/derating curves	13
16	Commercial Data.....	14
17	Combination tests.....	15

1156838 FQ 1,27D/ 30-SV- 490-1-BR**4 General Technical Data****4.1 item properties**

Order No.	1156838
Type	FQ 1,27D/ 30-SV- 490-1-BR
Connector system	FINEPITCH FQ 1,27
Product type	SMD socket
Type of contact	Female connector
Range of articles	FQ 1,27D/...-SV
Pitch	1.27 mm
Number of positions	30
Number of levels	2
Type of locking	without
Mounting type	SMD soldering
Connection direction of the connector to the PCB	90 °
Pin layout	Linear pad geometry

1156838 FQ 1,27D/ 30-SV- 490-1-BR**5 Mounting****5.1 Flange mounting**

Type of locking	without
-----------------	---------

5.2 Material of metal parts

Note	WEEE/RoHS-compliant, whisker-free acc. to IEC 60068-2-82/JEDEC JESD 201
Contact material	Cu alloy
Surface contact area	Nickel (Ni) , Gold (Au)
Soldering area surface	Tin (Sn)
Surface characteristics	Selective coating
Insulating material data	Housing
Color	black (9005)
Insulating material	PA
Insulating material group	I
CTI according to IEC 60112	600
Flammability rating according to UL 94	V0

1156838 FQ 1,27D/ 30-SV- 490-1-BR**6 Dimensions****6.1 Dimensions for the product**

Length	4.5 mm
Width	19.45 mm
Total height	5.1 mm
Installed height	4.6 mm
Coplanarity	≤ 0.1 mm

6.2 Dimensions for the application

Contact cover	0.4 mm
Overlap length	1.3 mm
Stacking height	6.2 mm Tolerance: +1.3 mm (in combination with Range of articles:FQ 1,27D/...-PV)

1156838 FQ 1,27D/ 30-SV- 490-1-BR

7 Series drawing

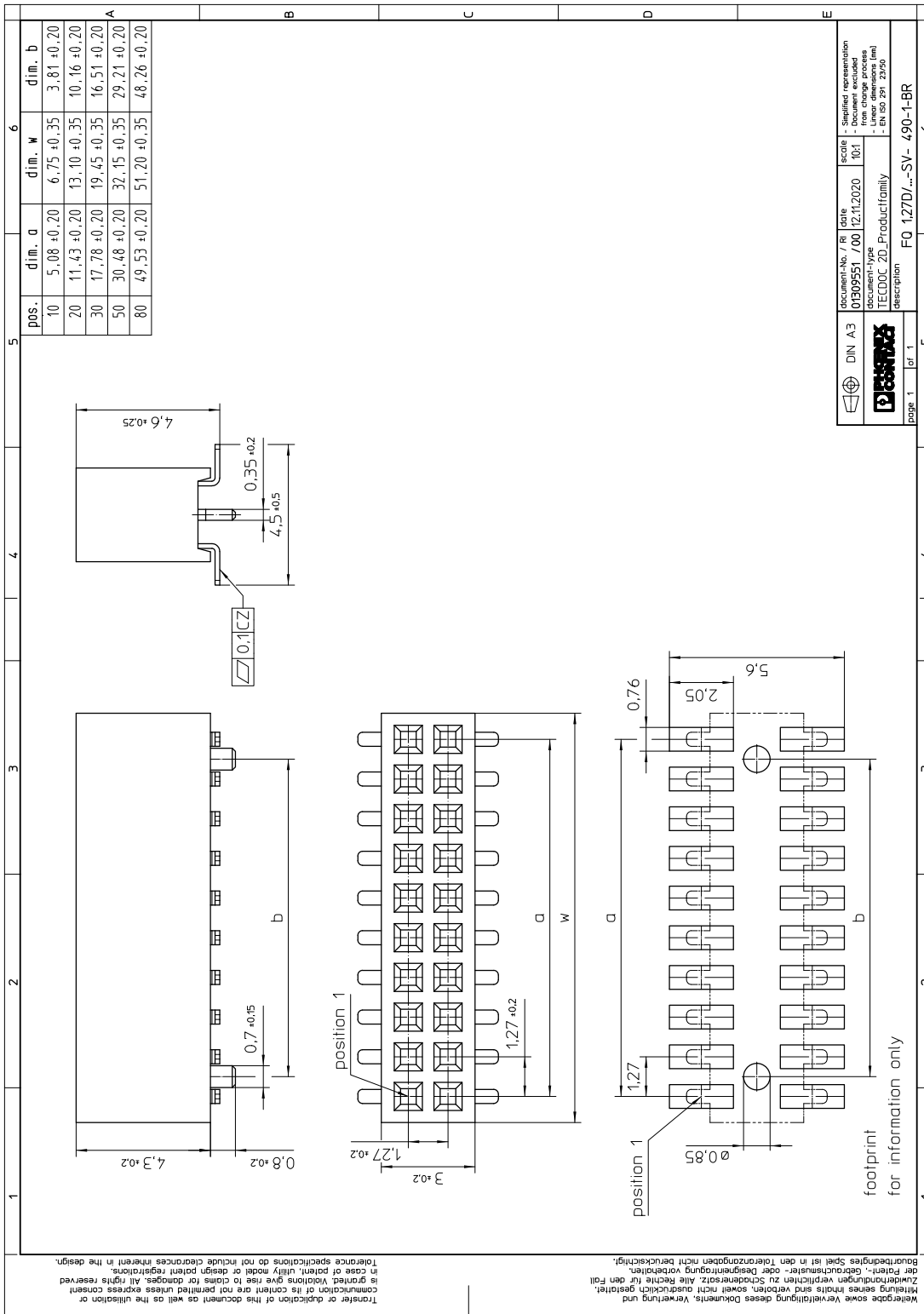

DIN A3	document-No. / R / title	scale	document type	description
01909551 700	12.11.2020	100%	TECDOC 2D_Productfamily	FQ 1,27D/...SV- 490-1-BR
document type		Simplified representation		
description		- from change process		
		- Linear dimensions (mm)		
		- EN ISO 299, 2950		
page 1	of 1			

Wiedergabe sowie Vervielfältigung dieses Dokuments, Verwertung und Verbreitung, insbesondere auch auszugsweise, ist ohne schriftliche Genehmigung der Phoenix Contact AG. Die Phoenix Contact AG übernimmt keine Haftung für die Richtigkeit der Angaben. Irrtümer und Änderungen vorbehalten. Alle Rechte vorbehalten. In case of patent, utility model or design patent registrations, the user is notified that the user is granted a license to use the product in the design. Tolerances specifications do not include clearances inherent in the design. Transfer or duplication of this document as well as the utilization or modification of its content are not permitted unless express consent is granted. Violations give rise to claims for damages. All rights reserved.

1156838 FQ 1,27D/ 30-SV- 490-1-BR

8 Product notes

8.1 General information

Notes on operation

The permissible voltage during operation depends on the application, taking into consideration the air clearances and creepage distances within the scope of insulation requirements in accordance with IEC 60664-1.

9 Packaging information

Type of packaging	32 mm wide tape
Pieces per package	900
Outer packaging type	Transparent-Bag
ESD level	(D) electrostatically conductive
Specification	DIN EN 61340-5-1 (VDE 0300-5-1): 2008-07
[W] tape width	32 mm
[A] coil diameter	330 mm
[W2] coil overall dimension	38.4 mm
Number of products per coil	900

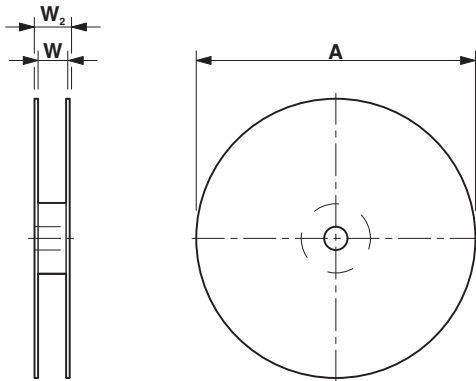

1156838 FQ 1,27D/ 30-SV- 490-1-BR

10 Blister drawing

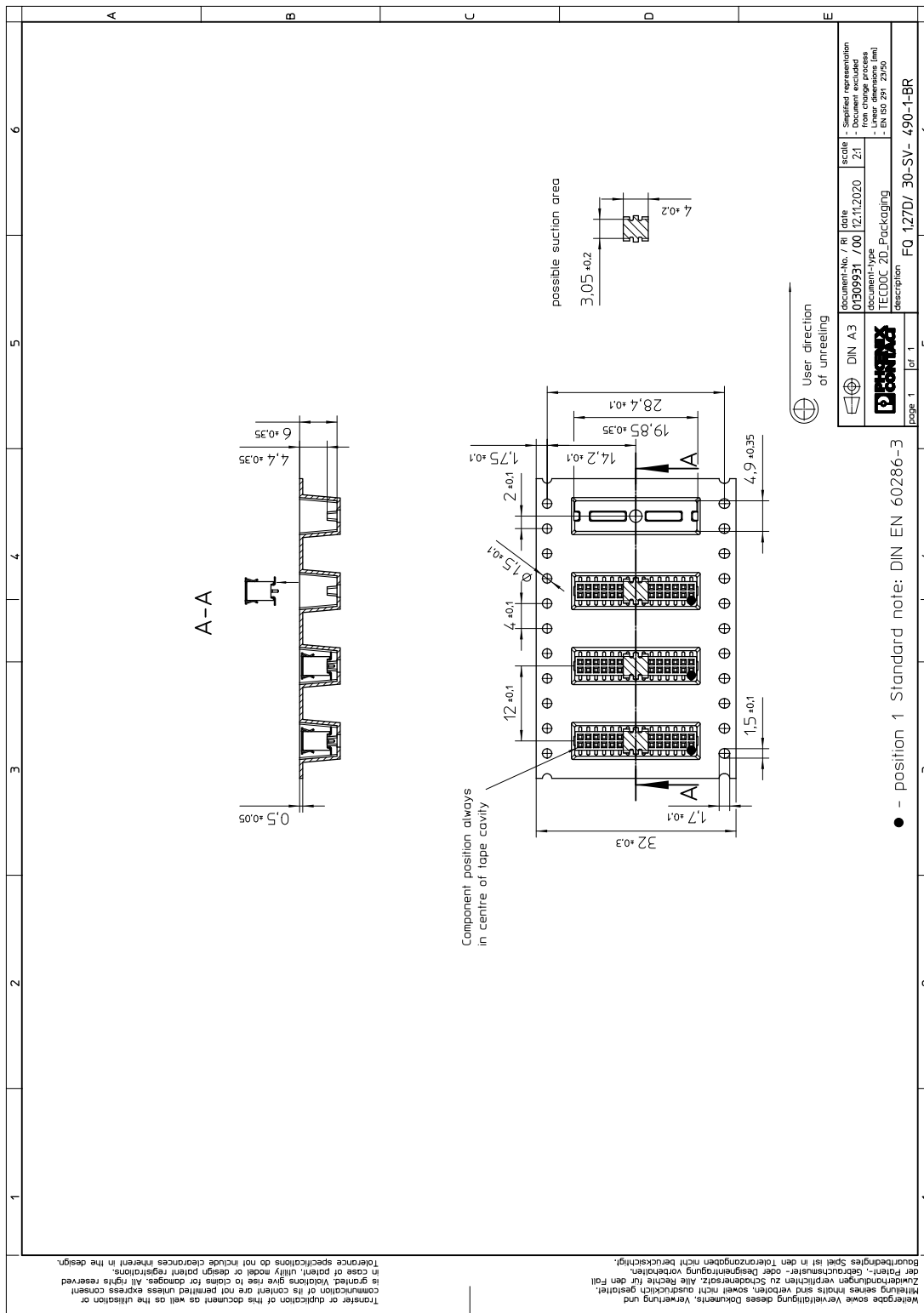

1156838 FQ 1,27D/ 30-SV- 490-1-BR

11 Application**11.1 Temperature limit values**

Ambient temperature (storage/transport)	-40 °C ... 70 °C
Ambient temperature (assembly)	-5 °C ... 100 °C
Ambient temperature (operation)	-40 °C ... 125 °C

1156838 FQ 1,27D/ 30-SV- 490-1-BR

12 General tests

12.1 Specification



Brief description

Board-to-board connectors

13 Mechanical tests

13.1 Insertion and withdrawal force per contact

Insertion and withdrawal force per contact	
	≤ 1.2 N
Specification	
	IEC 60512-9-1:2010-03 (following)
	100 Insertion/withdrawal cycles

1156838 FQ 1,27D/ 30-SV- 490-1-BR**14 Electrical tests**

Nominal current at 20 °C	1 A IEC 60512-5-2:2002-02 (80-pos.)
Test voltage	500 V AC IEC 60512-4-1:2003

14.1 Air and creepage distances

Minimum value for clearance and creepage distance	0.25 mm
---	---------

1156838 FQ 1,27D/ 30-SV- 490-1-BR**15 Current carrying capacity/derating curves**

Specification	IEC 60512-5-2:2002-02
Note	max. 1 A at 20°C (80-pos.)
Reduction factor	0.8

Type: FQ 1,27D/...-SV- 490-1-BR with FQ 1,27D/...-PV- 160-1-BR

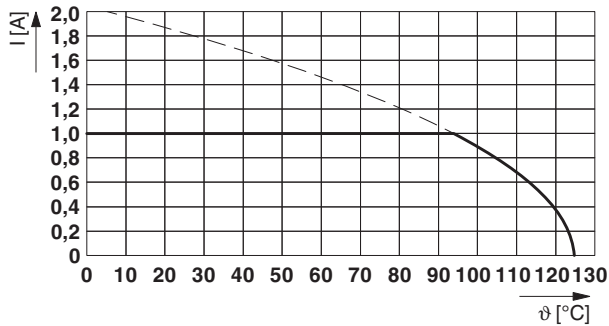
**15.1 Insulation resistance**

Insulation resistance	> 1 G Ω , (IEC 60512-3-1:2002-02)
-----------------------	--

15.2 forward resistance

Contact resistance	≤ 30 m Ω , (IEC 60512-2-1:2002-02)
--------------------	--

15.3 Vibration test

Specification	IEC 60068-2-6:2007-12
Result	Test passed
Frequency	10 - 55 - 10 Hz
Sweep speed	1 octave/min
Amplitude	1.52 mm
Acceleration	181 m/s ²
Test duration per axis	2 h
Test directions	X-, Y- and Z-axis
Note	

1156838 FQ 1,27D/ 30-SV- 490-1-BR

16 Commercial Data

Order No.	1156838
Type	FQ 1,27D/ 30-SV- 490-1-BR
Pieces per package	900
Net weight	2.22 g
GTIN	4063151159757
	Information that applies locally, see link on page 1

1156838 FQ 1,27D/ 30-SV- 490-1-BR

17 Combination tests

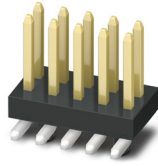
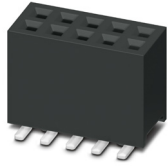
**FQ 1,27D/...-SV****FQ 1,27D/...-PV****Mechanical tests**

Insertion/withdrawal force per position

approx. 1.2 N / 1.2 N

Durability testsContact resistance R_1 20 m Ω

Insertion/withdrawal cycles

100

Contact resistance R_2 30 m Ω

Test voltage

500 V AC

Insulation resistance
Requirements > 5 M Ω > 1 G Ω **Thermal tests**

Tested number of positions

80

Test current

1 A

单击下面可查看定价，库存，交付和生命周期等信息

[>>Phoenix Contact\(菲尼克斯\)](#)