

Printed-circuit board connector - BCVP-508W-21 BK - 5452899

Please be informed that the data shown in this PDF Document is generated from our Online Catalog. Please find the complete data in the user's documentation. Our General Terms of Use for Downloads are valid (<http://phoenixcontact.com/download>)



Plug component, Nominal current: 12 A, Rated voltage (III/2): 320 V, Number of positions: 21, Pitch: 5.08 mm, Connection method: Screw connection with tension sleeve, Color: black, Contact surface: Tin

The figure shows a 5-pos. version of the product in gray



Key Commercial Data

Packing unit	1 pc
Minimum order quantity	100 pc
Custom tariff number	85366990
Country of origin	Germany

Classifications

eCl@ss

eCl@ss 4.0	272607xx
eCl@ss 4.1	27260701
eCl@ss 5.0	27260701
eCl@ss 5.1	27260701
eCl@ss 6.0	27261101
eCl@ss 7.0	27440401
eCl@ss 8.0	27440309
eCl@ss 9.0	27440309

ETIM

ETIM 3.0	EC001121
ETIM 4.0	EC002638
ETIM 5.0	EC002638

Printed-circuit board connector - BCVP-508W-21 BK - 5452899

Classifications

UNSPSC

UNSPSC 6.01	30211801
UNSPSC 7.0901	39121432
UNSPSC 11	39121432
UNSPSC 12.01	39121409
UNSPSC 13.2	39121432

Approvals

Approvals

Approvals

UL Recognized / cUL Recognized / VDE Gutachten mit Fertigungsüberwachung / IECCEB Scheme / cULus Recognized

Ex Approvals

Approvals submitted

Approval details

UL Recognized 		
	B	D
mm ² /AWG/kcmil	30-12	30-12
Nominal current I _N	12 A	10 A
Nominal voltage U _N	300 V	300 V

cUL Recognized 		
	B	D
mm ² /AWG/kcmil	30-12	30-12
Nominal current I _N	12 A	10 A
Nominal voltage U _N	300 V	300 V

Printed-circuit board connector - BCVP-508W-21 BK - 5452899

Approvals

VDE Gutachten mit Fertigungsüberwachung

IECEE CB Scheme

cULus Recognized

Drawings

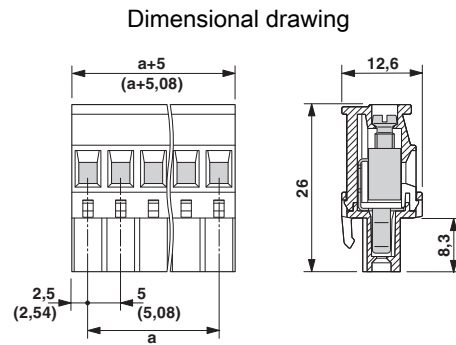
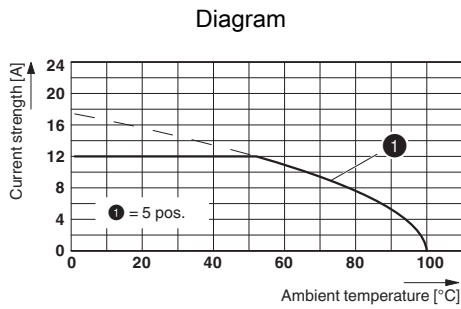

单击下面可查看定价，库存，交付和生命周期等信息

[>>Phoenix Contact \(菲尼克斯\)](#)