

## Bus system cable - SAC-4P-MINMR/20,0-960 VA - 1429486

Please be informed that the data shown in this PDF Document is generated from our Online Catalog. Please find the complete data in the user's documentation. Our General Terms of Use for Downloads are valid (<http://download.phoenixcontact.com>)



Bus system cable, FOUNDATION Fieldbus, Foundation Fieldbus, 3-position, PVC, orange RAL 2003, shielded, Plug angled 7/8"-16UNF, A-coded, on Free cable end, Cable length: 20 m



### Key commercial data

|                                      |            |
|--------------------------------------|------------|
| Packing unit                         | 1 1        |
| Weight per Piece (excluding packing) | 222.22 GRM |
| Custom tariff number                 | 85444290   |
| Country of origin                    | Germany    |

### Technical data

#### Dimensions

|  |       |
|--|-------|
| Length of cable                            | 20 m  |
| Stripping length of the free conductor end | 50 mm |

#### Ambient conditions

|                                 |                                   |
|---------------------------------|-----------------------------------|
| Ambient temperature (operation) | -40 °C ... 105 °C (Plug / socket) |
| Degree of protection            | IP67                              |

#### General

|                       |                     |
|-----------------------|---------------------|
| Rated current at 40°C | 5.2 A               |
| Rated voltage         | 300 V               |
| Number of positions   | 3                   |
| Contact resistance    | ≤ 5 mΩ              |
| Insulation resistance | ≥ 10 MΩ             |
| Coding                | A - standard        |
| Signal type/category  | FOUNDATION Fieldbus |

## Bus system cable - SAC-4P-MINMR/20,0-960 VA - 1429486

### Technical data

#### General

|                        |                          |
|------------------------|--------------------------|
| Status display         | No                       |
| Surge voltage category | II                       |
| Pollution degree       | 2                        |
| Torque                 | 0.8 Nm (7/8" connectors) |

#### Material

|   |                  |
|---|------------------|
| Inflammability class according to UL 94 | HB               |
| Contact material                        | CuZn             |
| Contact surface material                | AU               |
| Contact carrier material                | PA 66            |
| Material of grip body                   | TPU              |
| Material, knurls                        | High-grade steel |

#### Cable

|   |  |
|---|--|
| Cable type                                  | FOUNDATION Fieldbus orange   |
| Cable type (abbreviation)                   | 960  |
| Cable structure                             | 2xAWG18/7 + 1xAWG20/7  |
| Conductor cross section                     | 2x 0.75 mm <sup>2</sup> (signal line)<br>1x 0.5 mm <sup>2</sup> (Drain wire) |
| AWG signal line                             | 18   |
| Conductor structure signal line             | 7x 0.40 mm   |
| Core diameter including insulation          | 2.24 mm ±0.05 mm   |
| Thickness, insulation                       | 0.5 mm (Core insulation)<br>1 mm (Outer cable sheath)                        |
| Wire colors                                 | Blue, orange   |
| Twisted pairs                               | 2 cores to the pair  |
| Overall twist                               | One pair with one drain wire and fillers for core                            |
| Shielding                                   | Plastic-coated aluminum foil with a drain wire                               |
| Optical shield covering                     | 100 %  |
| External sheath, color                      | orange RAL 2003  |
| External cable diameter                     | 7.42 mm  |
| External cable diameter D                   | 7.5 mm ±0.25 mm  |
| Smallest bending radius, fixed installation | 75 mm  |
| Cable weight                                | 56.552 kg/km   |
| Outer sheath, material                      | PVC  |
| Material conductor insulation               | PO (signal line)   |
| Conductor material                          | Tin-plated Cu litz wires   |
| Conductor resistance                        | 19.2 Ω/km (signal line)  |

## Bus system cable - SAC-4P-MINMR/20,0-960 VA - 1429486

### Technical data

#### Cable

|                                 |                              |
|---------------------------------|------------------------------|
|                                 | 26 Ω/km (shield)             |
| Working capacitance             | 148 nF (core-shield)         |
|                                 | 78 nF (core-core)            |
| Wave impedance                  | 100 Ω (At 31.25 kHz)         |
| Signal speed                    | 0.66 c                       |
| Nominal voltage, cable          | 300 V                        |
| Special properties              | UL standards PLTC-ER and ITC |
| Flame resistance                | UL 1685 (CSA FT 4)           |
| Ambient temperature (operation) | -30 °C ... 105 °C (Cable)    |

### Classifications

#### eCl@ss

|            |          |
|------------|----------|
| eCl@ss 4.0 | 27060306 |
| eCl@ss 4.1 | 27060306 |
| eCl@ss 5.0 | 27061801 |
| eCl@ss 5.1 | 27061801 |
| eCl@ss 6.0 | 27061801 |
| eCl@ss 7.0 | 27061801 |
| eCl@ss 8.0 | 27061801 |

#### ETIM

|          |          |
|----------|----------|
| ETIM 3.0 | EC001855 |
| ETIM 4.0 | EC001855 |
| ETIM 5.0 | EC001855 |

#### UNSPSC

|               |          |
|---------------|----------|
| UNSPSC 6.01   | 31251501 |
| UNSPSC 7.0901 | 31251501 |
| UNSPSC 11     | 31251501 |
| UNSPSC 12.01  | 31251501 |
| UNSPSC 13.2   | 31251501 |

### Approvals

#### Approvals

## Bus system cable - SAC-4P-MINMR/20,0-960 VA - 1429486

### Approvals

Approvals

UL Listed / cUL Listed / GOST / cULus Listed

---

Ex Approvals

---

Approvals submitted

---

### Approval details

|   |       |
|---|-------|
| UL Listed  |       |
|   |       |
| Nominal current IN  | 5.2 A |
| Nominal voltage UN  | 300 V |

|  |       |
|--|-------|
| cUL Listed  |       |
|  |       |
| Nominal current IN   | 5.2 A |
| Nominal voltage UN   | 300 V |

|  |  |
|--|--|
| GOST  |  |
|--|--|

|  |  |
|--|--|
| cULus Listed  |  |
|--|--|

### Drawings

# Bus system cable - SAC-4P-MINMR/20,0-960 VA - 1429486

Schematic diagram

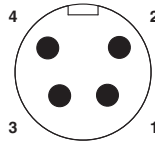

Pin assignment, plug, 7/8"-16UNF, 4-pos., view of male side

Cable cross section

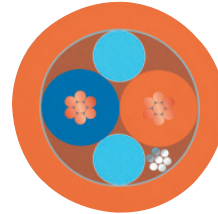

FOUNDATION Fieldbus orange [960]

Dimensioned drawing

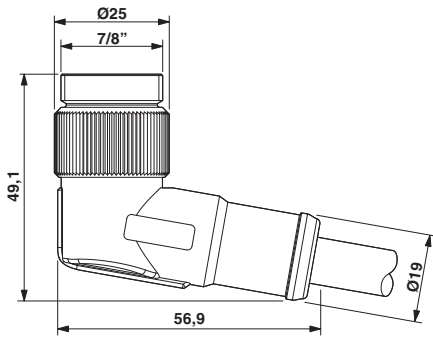

7/8"-16UNF plug, angled

Circuit diagram

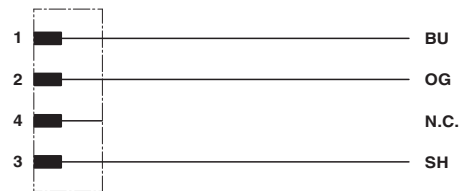

Contact assignment of the 7/8" plug

单击下面可查看定价，库存，交付和生命周期等信息

[>>Phoenix Contact\(菲尼克斯\)](#)