

Sensor/Actuator cable - SAC-3P- 5,0-PUR/BI-1L-Z - 1435250

Please be informed that the data shown in this PDF Document is generated from our Online Catalog. Please find the complete data in the user's documentation. Our General Terms of Use for Downloads are valid (<http://download.phoenixcontact.com>)



Sensor/Actuator cable, 3-position, PUR halogen-free, Black-gray RAL 7021, Free cable end, on BI valve plug (11 mm), with 1 LED, connected with Z diode, Cable length: 5 m

Key commercial data

Packing unit	0
Minimum order quantity	1
Catalog page	Page 166 (PC-2011)
GTIN	 4 046356 413589
Custom tariff number	85444290
Country of origin	POLAND

Technical data

General data

Rated current at 40°C	4 A
Rated voltage	24 V
Number of positions	3
Volume resistance	≤ 5 mΩ
Insulation resistance	≥ 100 MΩ
Length of cable	5 m
Stripping length of the free conductor end	50 mm
Ambient temperature (operation)	-20 °C ... 85 °C (valve plug)

General characteristics

Surge voltage category	III
Pollution degree	3
Degree of protection	IP65/67
Contact material	CuSn
Contact surface material	Sn
Valve plug contact insert material	PA 66
Material housing valve plug	TPU
Sealing material	TPU (Seal molded)
Status display	1 LED
Protective circuit/component	Z diode

Sensor/Actuator cable - SAC-3P- 5,0-PUR/BI-1L-Z - 1435250

Technical data

Conductor data

Cable type	PUR halogen-free black
Cable type (abbreviation)	PUR
Cable abbreviation	Li9Y11Y-HF
UL AWM Style	20549
Conductor cross section	3x 0.5 mm ²
AWG signal line	20
Conductor structure signal line	28x 0.15 mm
Core diameter including insulation	1.5 mm ±0.05 mm (signal line)
External cable diameter	4.5 mm ± 0.2 mm
Wire colors	Black 1, black 2, green/yellow
External sheath, color	Black-gray RAL 7021
Insulation resistance	min. 20 MΩ*km
Conductor resistance	39 Ω/km (at 20 °C)
Nominal voltage, conductor	≤ 300 V
Test voltage, conductor	≥ 1200 V
Overall twist	3 wires, twisted
Outer sheath, material	PUR
Material conductor insulation	PP
Conductor material	Bare Cu litz wires
Smallest bending radius, fixed installation	22.5 mm
Number of bending cycles	15000000
Bending radius	50 mm
Traversing path	0.9 m
Traversing rate	5 m/s
Acceleration	30 m/s ²
Ambient temperature (operation)	-40 °C ... 80 °C (cable, fixed installation)
Ambient temperature (operation)	-20 °C ... 80 °C (cable, flexible installation)
Flame resistance	According to DIN VDE 0482
Flame resistance	According to DIN EN 50265-2-1
Halogen-free	in accordance with DIN VDE 0472 part 815
Other resistance	Largely oil-resistant
Other resistance	partly UV-resistant in accordance with DIN EN ISO 4892-2-A

Classifications

eclass

eCl@ss 4.0	27060306
eCl@ss 4.1	27060306
eCl@ss 5.0	27061801
eCl@ss 5.1	27061801
eCl@ss 6.0	27061801
eCl@ss 7.0	27061801

Sensor/Actuator cable - SAC-3P- 5,0-PUR/BI-1L-Z - 1435250

Classifications

etim

ETIM 3.0	EC001855
ETIM 4.0	EC001855

unspsc

UNSPSC 6.01	31251501
UNSPSC 7.0901	31251501
UNSPSC 11	31251501
UNSPSC 12.01	31251501
UNSPSC 13.2	31251501

Approvals

Approvals

Approvals

GOST

Ex Approvals

Approvals submitted

Approval details



Accessories

Accessories

Assembly

Screw - SAC-V-SCREW-M3-29 KNURL - 1403779



Fillister head screw with plastic knurl, M3 x 40

Marking

Sensor/Actuator cable - SAC-3P- 5,0-PUR/BI-1L-Z - 1435250

Accessories

Insert label - PABA WH/15 - 1013151



Insert label, white, Unlabeled, Can be labeled with: Plotter, Mounting type: Thread on, Cable diameter: 0.6-50 mm, Lettering field: 15 x 4 mm

Insert label - PABA YE/15 - 1013698



Insert label, yellow, Unlabeled, Can be labeled with: Plotter, Mounting type: Thread on, Cable diameter: 0.6-50 mm, Lettering field: 15 x 4 mm

Insert label - PABA RD/15 - 1013944



Insert label, red, Unlabeled, Can be labeled with: Plotter, Mounting type: Thread on, Cable diameter: 0.6-50 mm, Lettering field: 15 x 4 mm

Conductor marker carrier - PATG 2/23 - 1013850



Conductor marker carrier, transparent, Unlabeled, Mounting type: Slide on, Cable diameter: 2-4 mm, Lettering field: 4 x 23 mm

Conductor marker carrier - PATG 3/23 - 1013863



Conductor marker carrier, transparent, Unlabeled, Mounting type: Slide on, Cable diameter: 4-7 mm, Lettering field: 4 x 23 mm

Conductor marker carrier - PATG 4/23 - 0808011



Conductor marker carrier, transparent, Unlabeled, Mounting type: Slide on, Cable diameter: 6-10 mm, Lettering field: 4 x 23 mm

Sensor/Actuator cable - SAC-3P- 5,0-PUR/BI-1L-Z - 1435250

Accessories

Marker pen - B-STIFT - 1051993



Marker pen, for manual labeling of unprinted Zack strips, smear-proof and waterproof, line thickness 0.5 mm

Tools

Torque screwdriver - TSD-M 1,2NM - 1212224



Torque screw driver, accuracy as per EN ISO 6789 standard, adjustable from 0.3 - 1.2 Nm

Screw insert - SF-BIT-PH 1-70 - 1212582



Screw bit, PH crosshead, E6.3-1/4" drive, size: PH 1 x 70 mm, hardened, suitable for holder according to DIN 3126-F6.3/ISO 1173

Cable-cutting tool - CUTFOX-S VDE - 1212207



Diagonal cutter for copper and aluminum conductors, VDE-tested

Stripping tool - WIREFOX SAC - 1212623



Stripping pliers, for halogen-free sensor/actuator cables (SAC cables), with PUR and PVC insulation, from Ø of 4.4 to 7 mm, any stripping length

Sensor/Actuator cable - SAC-3P- 5,0-PUR/BI-1L-Z - 1435250

Accessories

Stripping tool - WIREFOX 10 - 1212150



Stripping tool, for cables and conductors from 0.02 - 10 mm², self-adjusting, stripping length of up to 18 mm, cutting capacity of up to 10 mm² stranded/1.5 mm² solid, replaceable stripping blade

Drawings

Schematic diagram

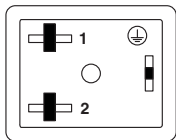

Valve connector pin assignment, type BI

Cable cross section

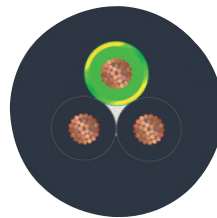

PUR halogen-free black [PUR]

Dimensioned drawing

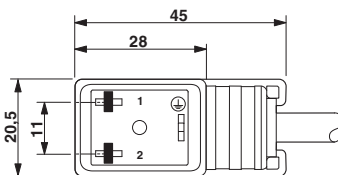

Valve connector, type BI

Dimensioned drawing

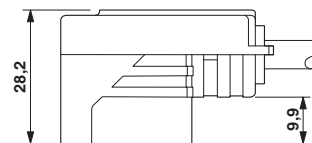

Valve connector, type BI, side view

Sensor/Actuator cable - SAC-3P- 5,0-PUR/BI-1L-Z - 1435250

Circuit diagram

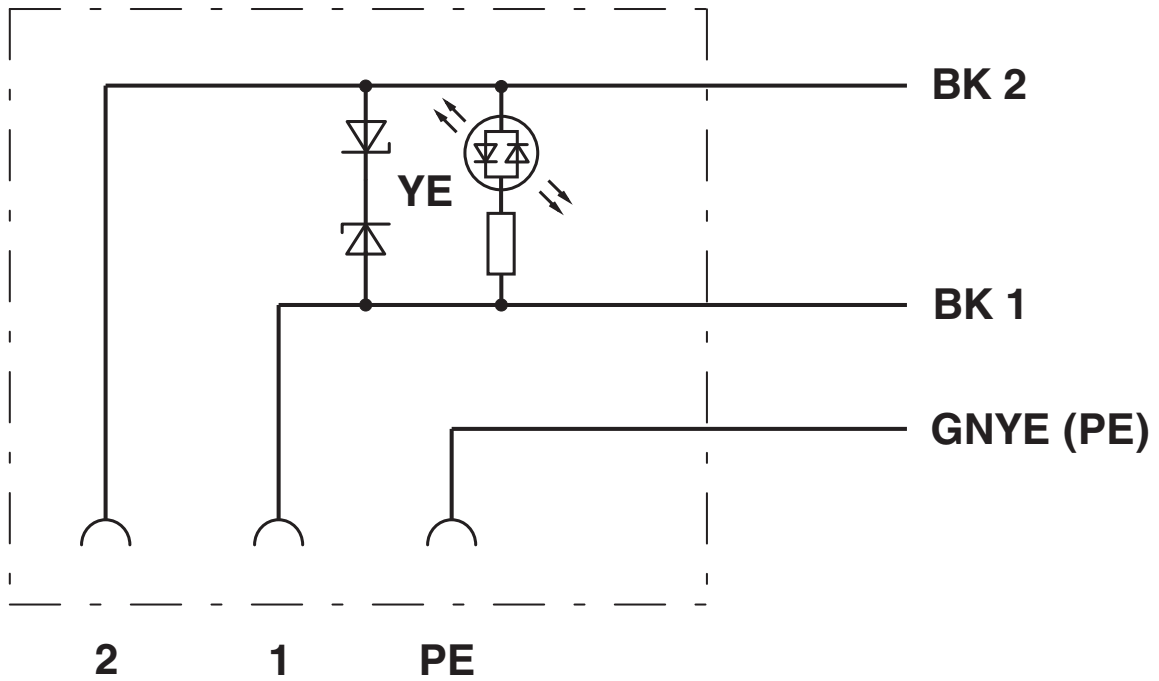

单击下面可查看定价，库存，交付和生命周期等信息

[>>Phoenix Contact\(菲尼克斯\)](#)