



PT – Push-in connection

CLIPLINE complete

Push-in connection technology

Rigid conductors or those assembled with ferrules can be plugged directly into the PT Push-in connection terminal blocks without tools. The special spring profile enables conductors of 0.25 mm² or higher to be inserted easily. The contact spring is opened automatically when the conductor is pushed in, thus ensuring the required pressure force. The spring is opened using the push button, whether for releasing conductors or for connecting smaller cross sections of 0.14 mm² or higher.



Push-in Technology 
Designed by PHOENIX CONTACT

Contents

PT terminal blocks	4
PTV terminal blocks with lateral conductor connection	18
PTPOWER high-current terminal blocks	22
PTIO sensor/actuator terminal blocks	26
PT disconnect and knife disconnect terminal blocks	30
PT four-level terminal blocks	38
PTRV marshaling terminals	42
PTMC marshaling patchboards	46
PTME test disconnect terminal blocks	52
PTI installation terminal blocks	58
PT plug-in terminal blocks	66

Find out more with the web code

For detailed information, use the web codes provided in this brochure. Simply enter # and the four-digit number in the search field on our website.

 **Web code:** #1234 (example)

Or use the direct link:
phoenixcontact.net/webcode/#1234

Push-in connection technology

Easy to use – high-performance connection

The quality of our products is our top priority. Quality is not only tested in retrospect on finished products, but is ensured with responsibility during every step of production.

Our Push-in connection technology has been tested and approved for a range of approvals. It is also certified for use in areas with increased safety, Ex e.



Reliable in every application

Push-in connection technology is subjected to tests which go beyond the basic standard. This means they can be used in all sectors, such as energy supply, transportation technology, process engineering, and the chemical, petrochemical, and shipbuilding industries in particular. Detailed information for approved products on their use in Ex “e” and “i” areas is available on the Internet as a download.



Vibration-resistant contacting

Push-in connection technology is tested for maximum vibration and shock resistance. The test objects are tested in each of the three axes (x, y, z) up to 350g.

Easy and tool-free direct insertion

The reduction in insertion force of up to 50% permits easy, direct insertion of rigid and flexible conductors with ferrules with a cross section 0.25 mm² or larger.

Reliable contact

High-quality, hard-faced copper alloys ensure the lowest contact resistance and, therefore, maximum current transfer.

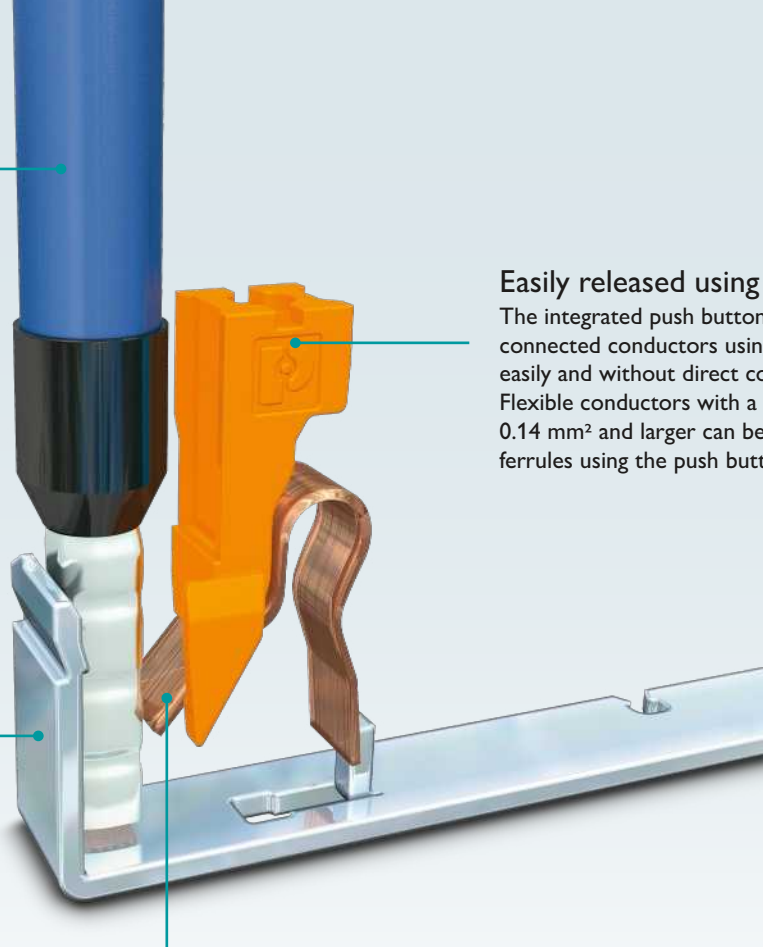

Easily released using any tool

The integrated push button enables you to release connected conductors using any type of tool – easily and without direct contact with live parts. Flexible conductors with a cross section of 0.14 mm² and larger can be connected without ferrules using the push button.

Maximum forces

The special contact spring is manufactured from high-quality spring steel, which ensures maximum contact and conductor pull-out force with vibration-resistant and gas-tight connection.

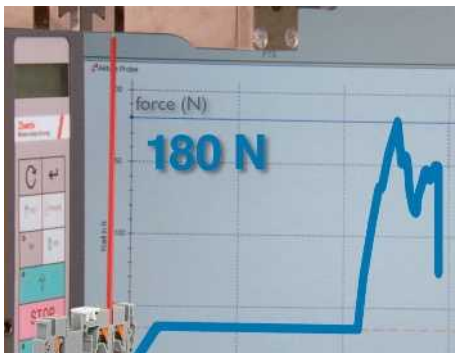

Maximum conductor pull-out forces

The Push-in connection achieves 180 N in the conductor pull-out test of, for example, a 2.5 mm² terminal block with a 1.0 mm² conductor, although only 35 N is required according to the standard.



Gas-tight contacting

The Push-in connection establishes gas-tight connections that cannot be negatively affected even in atmospheres containing sulfur dioxide or salt mist.

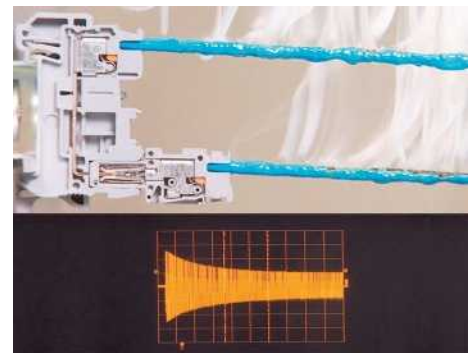

High-performance contacting

The conductor contact points provide the highest level of contact reliability. The terminal blocks withstand short-circuit currents without damage until the safety equipment disconnects the current.

Simply consistent – PT terminal blocks

The consistent function shaft in all Push-in terminal blocks provides you with a high degree of flexibility and simplifies project planning and configuration of the control cabinet. All terminal blocks can be freely combined with one another. CLIPLINE complete system accessories, such as bridging, marking, and testing accessories, are standardized and significantly reduce your logistics costs.



i Web code: #1126

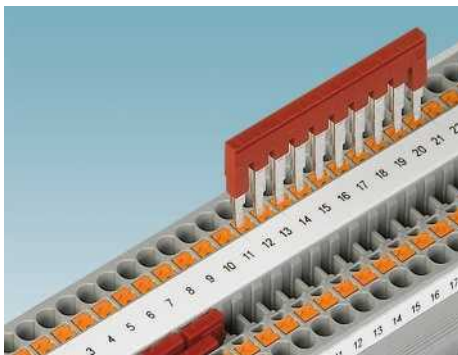

Potential bridging

The terminal blocks have two function shafts that enable fast, individual potential distribution. All potential bridging tasks can therefore be realized.

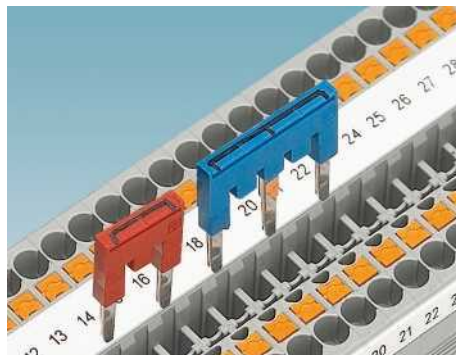

Bridging between non-adjacent terminal blocks

Bridging between non-adjacent terminal blocks is established by removing individual contact tabs from the standard bridge.



Easy potential distribution

The reducing bridge enables terminal blocks with different nominal cross sections to be connected easily.

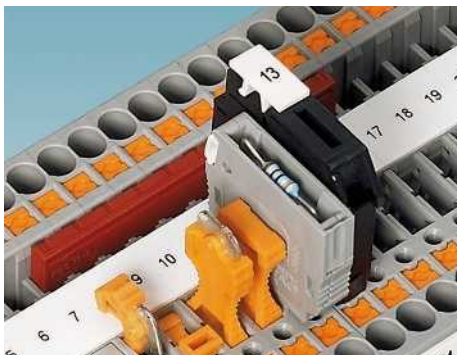

Multifunctional disconnect zone

All disconnect terminal blocks have a standardized disconnect zone. The disconnect zone accommodates various connectors, such as fuse plugs, component connectors, and isolating plugs.

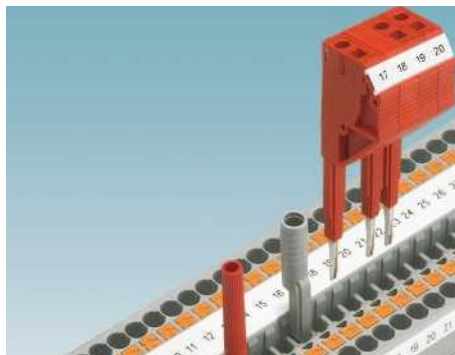

Standardized plug-in test system

























A test plug with 2.3 mm diameter is available for individual measuring lines. More complex testing tasks can be realized using alignable test plugs.

















Large-surface labeling

Each terminal point has space for unique, large-surface labeling to ensure the best possible overview of the control cabinet.





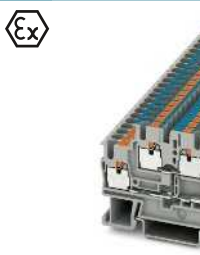

PT terminal blocks

Two-conductor terminals							
	gray blue green-yellow black/yellow	PT 1,5/S PT 1,5/S BU PT 1,5/S-PE PT 1,5/S-FE	3208100 3208126 3208139 1077075	PT 2,5 PT 2,5 BU PT 2,5-PE PT 2,5-FE	3209510 3209523 3209536 1077080	PT 4 PT 4 BU PT 4-PE PT 4-FE	3211757 3211760 3211766 1077082
Width / Length / Height	[mm]	3.5 / 45 / 32		5.2 / 48.5 / 36.5		6.2 / 56 / 36.5	
Current / voltage // UL	[A] / [V]	17.5 // 500 / 15 / 600		24 // 800 / 20 / 600		32 // 800 / 30 / 600	
rigid / AWG // flexible / AWG	[mm ²] / [-]	0.14 - 1.5 / 26 - 14 // 0.14 - 1.5 / 26 - 14		0.14 - 4 / 26 - 12 // 0.14 - 2.5 / 26 - 14		0.2 - 6 / 24 - 10 // 0.2 - 4 / 24 - 12	
Stranded with ferrule without / with plastic sleeve	[mm ²]	0.14 - 1.5 / 0.14 - 1		0.14 - 2.5 / 0.14 - 2.5		0.25 - 4 / 0.25 - 4	
Directly pluggable: with ferrule / rigid	[mm ²]	0.34 - 1.5 / 0.25 - 1.5		0.34 - 2.5 / 0.34 - 4		0.5 - 4 / 0.5 - 6	
							
	gray blue green-yellow black/yellow	PT 6 PT 6 BU PT 6-PE PT 6-FE	3211813 3211819 3211822 1077085	PT 10 PT 10 BU PT 10-PE PT 10-FE	3212120 3212123 3212131 1077088	PT 16 N PT 16 N BU PT 16 N-PE PT 16 N-FE	3212138 3212142 3212147 1077090
Width / Length / Height	[mm]	8.2 / 57.7 / 43.5		10.2 / 67.7 / 50.5		12.2 / 75.4 / 52.6	
Current / voltage // UL	[A] / [V]	41 // 1,000 / 40 / 600		57 // 1,000 / 60 / 600		76 // 1,000 / 85 / 600	
rigid / AWG // flexible / AWG	[mm ²] / [-]	0.5 - 10 / 20 - 8 // 0.5 - 6 / 20 - 10		0.5 - 16 / 20 - 6 // 0.5 - 10 / 20 - 8		0.5 - 25 / 20 - 4 // 0.5 - 16 / 20 - 6	
Stranded with ferrule without / with plastic sleeve	[mm ²]	0.5 - 6 / 0.5 - 6		0.5 - 10 / 0.5 - 10		0.5 - 16 / 0.5 - 16	
Directly pluggable: with ferrule / rigid	[mm ²]	1 - 6 / 1 - 10		4 - 10 / 1 - 16		2.5 - 16 / 2.5 - 25	
Three-conductor terminal blocks							
	gray blue green-yellow	PT 1,5/S-TWIN PT 1,5/S-TWIN BU PT 1,5/S-TWIN-PE	3208155 3208168 3208171	PT 2,5-TWIN PT 2,5-TWIN BU PT 2,5-TWIN-PE	3209549 3209552 3209565	PT 4-TWIN PT 4-TWIN BU PT 4-TWIN-PE	3211771 3211775 3211780
Width / Length / Height	[mm]	3.5 / 54 / 32		5.2 / 60.5 / 36.5		6.2 / 66.5 / 36.5	
Current / voltage // UL	[A] / [V]	17.5 // 500 / 15 / 600		24 // 800 / 20 / 600		32 // 800 / 30 / 600	
rigid / AWG // flexible / AWG	[mm ²] / [-]	0.14 - 1.5 / 26 - 14 // 0.14 - 1.5 / 26 - 14		0.14 - 4 / 26 - 12 // 0.14 - 2.5 / 26 - 14		0.2 - 6 / 24 - 10 // 0.2 - 4 / 24 - 12	
Stranded with ferrule without / with plastic sleeve	[mm ²]	0.14 - 1.5 / 0.14 - 1		0.14 - 2.5 / 0.14 - 2.5		0.25 - 4 / 0.25 - 4	
Directly pluggable: with ferrule / rigid	[mm ²]	0.34 - 1.5 / 0.25 - 1.5		0.34 - 2.5 / 0.34 - 4		0.5 - 4 / 0.5 - 6	
							
	gray blue green-yellow	PT 6-TWIN PT 6-TWIN BU PT 6-TWIN-PE	3211929 3211485 3211498	PT 10-TWIN PT 10-TWIN BU PT 10-TWIN-PE	3208746 3208747 3208745	PT 16-TWIN N PT 16-TWIN N BU PT 16-TWIN N-PE	3208760 3208773 3208786
Width / Length / Height	[mm]	8.2 / 74.2 / 43.5		10.2 / 88.9 / 50.5		12.2 / 100.2 / 52.6	
Current / voltage // UL	[A] / [V]	41 // 1,000 / 40 / 600		57 // 1,000 / 60 / 600		76 // 1,000 / 85 / 600	
rigid / AWG // flexible / AWG	[mm ²] / [-]	0.5 - 10 / 20 - 8 // 0.5 - 6 / 20 - 10		0.5 - 16 / 20 - 6 // 0.5 - 10 / 20 - 8		0.5 - 25 / 20 - 4 // 0.5 - 16 / 20 - 6	
Stranded with ferrule without / with plastic sleeve	[mm ²]	0.5 - 6 / 0.5 - 6		0.5 - 10 / 0.5 - 10		0.5 - 16 / 0.5 - 16	
Directly pluggable: with ferrule / rigid	[mm ²]	1 - 6 / 1 - 10		4 - 10 / 1 - 16		2.5 - 16 / 2.5 - 25	









PT terminal blocks

Four-conductor terminal blocks					
... -U = with interrupted current bar					
	gray gray blue green-yellow	PT 1,5/S-QUATTRO PT 1,5/S-QUATTRO-U PT 1,5/S-QUATTRO BU PT 1,5/S-QUATTRO-PE	3208197 3208359 3208208 3208333	PT 2,5-QUATTRO PT 2,5-QUATTRO BU PT 2,5-QUATTRO-PE	3209578 3209581 3209594
Width / Length / Height	[mm]	3.5 / 63.2 / 32		5.2 / 72.2 / 36.8	5.2 / 48.6 / 36.7
Current / voltage // UL	[A] / [V]	17.5 // 500 / 15 / 600		24 // 800 / 20 / 600	17.5 // 500 / 20 / 600
rigid / AWG // flexible / AWG	[mm ²] / [-]	0.14 - 1.5 / 26 - 14 // 0.14 - 1.5 / 26 - 14		0.14 - 4 / 26 - 12 // 0.14 - 2.5 / 26 - 14	0.14 - 2.5 / 26 - 12 // 0.14 - 1.5 / 26 - 16
Stranded with ferrule without / with plastic sleeve	[mm ²]	0.14 - 1.5 / 0.14 - 1		0.14 - 2.5 / 0.14 - 2.5	0.14 - 1.5 / 0.14 - 1.5
Directly pluggable: with ferrule / rigid	[mm ²]	0.34 - 1.5 / 0.25 - 1.5		0.34 - 2.5 / 0.34 - 4	0.34 - 1.5 / 0.34 - 2.5
					
	gray blue green-yellow	PT 4-QUATTRO PT 4-QUATTRO BU PT 4-QUATTRO-PE	3211797 3211802 3211809	PT 6-QUATTRO PT 6-QUATTRO BU PT 6-QUATTRO-PE	3212934 3212947 3212950
Width / Length / Height	[mm]	6.2 / 77 / 36.5		8.2 / 90.5 / 43.5	
Current / voltage // UL	[A] / [V]	32 // 800 / 30 / 600		41 // 1,000 / 40 / 600	
rigid / AWG // flexible / AWG	[mm ²] / [-]	0.2 - 6 / 24 - 10 // 0.2 - 4 / 24 - 12		0.5 - 10 / 20 - 8 // 0.5 - 6 / 20 - 10	
Stranded with ferrule without / with plastic sleeve	[mm ²]	0.25 - 4 / 0.25 - 4		0.5 - 6 / 0.5 - 6	
Directly pluggable: with ferrule / rigid	[mm ²]	0.5 - 4 / 0.5 - 6		1 - 6 / 1 - 10	
Double-level terminal blocks					
... -PV = with equipotential bonding					
	gray gray blue green-yellow	PTTB 1,5/S PTTB 1,5/S-PV PTTB 1,5/S BU PTTB 1,5/S-PE	3208511 3208540 3208524 3208537	PTTB 2,5 PTTB 2,5-PV PTTB 2,5 BU PTTB 2,5-PE	3210567 3210583 3210570 3210596
Width / Length / Height	[mm]	3.5 / 65.4 / 42.6		5.2 / 68 / 47.5	6.2 / 83.5 / 47.5
Current / voltage // UL	[A] / [V]	16 // 500 / 15 / 600		22 // 500 / 20 / 600	28 // 500 / 28 / 600
rigid / AWG // flexible / AWG	[mm ²] / [-]	0.14 - 1.5 / 26 - 14 // 0.14 - 1.5 / 26 - 14		0.14 - 4 / 26 - 12 // 0.14 - 2.5 / 26 - 14	0.2 - 6 / 24 - 10 // 0.2 - 4 / 24 - 12
Stranded with ferrule without / with plastic sleeve	[mm ²]	0.14 - 1.5 / 0.14 - 1		0.14 - 2.5 / 0.14 - 2.5	0.25 - 4 / 0.25 - 4
Directly pluggable: with ferrule / rigid	[mm ²]	0.34 - 1.5 / 0.25 - 1.5		0.34 - 2.5 / 0.34 - 4	0.5 - 4 / 0.5 - 6
... L/N = upper level blue, lower level gray ... PE/L = upper level gray, lower level gray-yellow with PE foot ... PE/N = upper level blue, lower level green-yellow with PE foot					
PTTB 4-L 1000 V enclosed housing					
	gray gray gray	PTTB 1,5/S-L/N PTTB 1,5/S-PE/L PTTB 1,5/S-PE/N	3208544 3208553 3208566	PTTB 2,5-L/N PTTB 2,5-PE/L PTTB 2,5-PE/N	3210994 3210978 3210981
Width / Length / Height	[mm]	3.5 / 65.4 / 42.6		5.2 / 68 / 47.5	8.2 / 83.5 / 47.5
Current / voltage // UL	[A] / [V]	16 // 500 / 15 / 600		22 // 500 / 20 / 300	32 // 1,000 / 30 / 1,000
rigid / AWG // flexible / AWG	[mm ²] / [-]	0.14 - 1.5 / 26 - 14 // 0.14 - 1.5 / 26 - 14		0.14 - 4 / 26 - 12 // 0.14 - 2.5 / 26 - 14	0.2 - 6 / 24 - 10 // 0.2 - 4 / 24 - 12
Stranded with ferrule without / with plastic sleeve	[mm ²]	0.14 - 1.5 / 0.14 - 1		0.14 - 2.5 / 0.14 - 2.5	0.25 - 4 / 0.25 - 4
Directly pluggable: with ferrule / rigid	[mm ²]	0.34 - 1.5 / 0.25 - 1.5		0.34 - 2.5 / 0.34 - 4	0.5 - 4 / 0.5 - 6







PT terminal blocks

Multi-conductor double-level terminal blocks					
... -PV = with equipotential bonding					
	gray gray blue green-yellow	PTTBS 2,5-TWIN PTTBS 2,5-TWIN-PV PTTBS 2,5-TWIN BU PTTBS 2,5-TWIN-PE	3210600 3210603 3210601 3210602	PTTBS 2,5-QUATTRO PTTBS 2,5-QUATTRO-PV PTTBS 2,5-QUATTRO BU PTTBS 2,5-QUATTRO-PE	3210609 3210612 3210610 3210611
Width / Length / Height	[mm]	5.2 / 111.8 / 55		5.2 / 115.2 / 55	
Current / voltage // UL	[A] / [V]	20 // 800 / 20 / 600		20 // 800 / 20 / 600	
rigid / AWG // flexible / AWG	[mm²] / [-]	0.14 - 4 / 26 - 12 // 0.14 - 2.5 / 26 - 14		0.14 - 4 / 26 - 12 // 0.14 - 2.5 / 26 - 14	
Stranded with ferrule without / with plastic sleeve	[mm²]	0.14 - 2.5 / 0.14 - 2.5		0.14 - 2.5 / 0.14 - 2.5	
Directly pluggable: with ferrule / rigid	[mm²]	0.34 - 2.5 / 0.34 - 4		0.34 - 2.5 / 0.34 - 4	
Three-level terminal blocks					
... -PV = with equipotential bonding					
	gray gray blue green-yellow	PT 1,5/S-3L PT 1,5/S-3PV PT 1,5/S-3L BU PT 1,5/S-3PE	3213713 3213742 3213726 3213739	PT 2,5-3L PT 2,5-3PV PT 2,5-3L BU PT 2,5-3PE	3210499 3210512 3210509 3210525
Width / Length / Height	[mm]	3.5 / 97.2 / 53.2		5.2 / 102 / 58	
Current / voltage // UL	[A] / [V]	15 // 500 / 15 / 600		20 // 500 / 20 / 300	
rigid / AWG // flexible / AWG	[mm²] / [-]	0.14 - 1.5 / 26 - 14 // 0.14 - 1.5 / 26 - 14		0.14 - 4 / 26 - 12 // 0.14 - 2.5 / 26 - 14	
Stranded with ferrule without / with plastic sleeve	[mm²]	0.14 - 1.5 / 0.14 - 1		0.14 - 2.5 / 0.14 - 2.5	
Directly pluggable: with ferrule / rigid	[mm²]	0.34 - 1.5 / 0.25 - 1.5		0.34 - 2.5 / 0.34 - 4	
... PE/L/N = upper level blue, middle level gray, lower level green-yellow with PE foot ... PE/L/L = upper and middle level gray, lower level green-yellow with PE foot					
	gray gray	PT 1,5/S-PE/L/N PT 1,5/S-PE/L/L	3213755 3213768	PT 2,5-PE/L/N PT 2,5-PE/L/L	3210538 3210541
Width / Length / Height	[mm]	3.5 / 97.2 / 53.2		5.2 / 102 / 58	6.2 / 119.5 / 56
Current / voltage // UL	[A] / [V]	15 // 500 / 15 / 600		20 // 500 / 20 / 300	30 // 500 / 20 / 600
rigid / AWG // flexible / AWG	[mm²] / [-]	0.14 - 1.5 / 26 - 14 // 0.14 - 1.5 / 26 - 14		0.14 - 4 / 26 - 12 // 0.14 - 2.5 / 26 - 14	0.2 - 6 / 24 - 10 // 0.2 - 4 / 24 - 10
Stranded with ferrule without / with plastic sleeve	[mm²]	0.14 - 1.5 / 0.14 - 1		0.14 - 2.5 / 0.14 - 2.5	0.25 - 4 / 0.25 - 4
Directly pluggable: with ferrule / rigid	[mm²]	0.34 - 1.5 / 0.25 - 1.5		0.34 - 2.5 / 0.34 - 4	0.5 - 4 / 0.5 - 6
					
	gray	PT 2,5-L/L/N	3210500		
Width / Length / Height	[mm]	5.2 / 102 / 58			
Current / voltage // UL	[A] / [V]	20 // 500 / 20 / 300			
rigid / AWG // flexible / AWG	[mm²] / [-]	0.14 - 4 / 26 - 12 // 0.14 - 2.5 / 26 - 14			
Stranded with ferrule without / with plastic sleeve	[mm²]	0.14 - 2.5 / 0.14 - 2.5			
Directly pluggable: with ferrule / rigid	[mm²]	0.34 - 2.5 / 0.34 - 4			

PT terminal blocks

Motor terminals					
	gray	PT 2,5-PE/3L	3210542	PT 4-PE/3L	3210442
Width / Length / Height	[mm]	5.2 / 99.5 / 92.6		6.2 / 104.4 / 96.9	
Current / voltage // UL	[A] / [V]	20 // 800 / 20 / 600		26 // 800 / 28 / 600	
rigid / AWG // flexible / AWG	[mm ²] / [-]	0.14 - 4 / 26 - 12 // 0.14 - 2.5 / 26 - 14		0.2 - 6 / 24 - 10 // 0.2 - 4 / 24 - 12	
Stranded with ferrule without / with plastic sleeve	[mm ²]	0.14 - 2.5 / 0.14 - 2.5		0.25 - 4 / 0.25 - 4	
Directly pluggable: with ferrule / rigid	[mm ²]	0.34 - 2.5 / 0.34 - 4		0.5 - 4 / 0.5 - 6	
Fuse terminal blocks					
PT 4-HESI/LED 24 (5X20) – for 12-30 V AC/DC, 0.31-0.95 mA PT 4-HESI/LED 60 (5X20) – for 30-60 V AC/DC, 0.40-0.86 mA PT 4-HESILA 250 (5X20) – for 110-250 V AC/DC, 0.41-0.96 mA PT 4-FSI/F-LED 12 – for 12 V DC, 1.7 mA PT 4-FSI/F-LED 24 – for 24 V DC, 1.9 mA					
	black	PT 4-HESI (5X20)	3211861	PTC 4-HESI (5X20)	3270200
	black	PT 4-HESI/LED 24 (5X20)	3211903	PTC 4-HESI/LED 24 (5X20)	3270203
	black	PT 4-HESI/LED 60 (5X20)	3207908	PTC 4-HESI/LED 60 (5X20)	3270205
	black	PT 4-HESILA 250 (5X20)	3211907	PTC 4-HESILA 250 (5X20)	3270197
Width / Length / Height	[mm]	6.2 / 56 / 64.8		8.2 / 67.8 / 42.8	6.2 / 56 / 36.5
Current / voltage // UL	[A] / [V]	6.3 // 500 / 6.3 / 400		6.3 // 500 / 6.3 / 300	10 // 400 / - / -
rigid / AWG // flexible / AWG	[mm ²] / [-]	0.2 - 6 / 24 - 10 // 0.2 - 4 / 24 - 12		0.2 - 6 / 24 - 10 // 0.2 - 4 / 24 - 12	0.2 - 6 / 24 - 10 // 0.2 - 4 / 24 - 12
Stranded with ferrule without / with plastic sleeve	[mm ²]	0.25 - 4 / 0.25 - 4		0.25 - 4 / 0.25 - 4	0.25 - 4 / 0.25 - 4
Directly pluggable: with ferrule / rigid	[mm ²]	0.5 - 4 / 0.5 - 6		0.5 - 4 / 0.5 - 6	0.5 - 4 / 0.5 - 6
	black	PTTB 4-HESI (5X20)	3211886	 PT 4-L/HESI (5X20)	3002608
	black	PTTB 4-HESI/LED 24 (5X20)	3211888	 PT 4-L/HESI/LED 24 (5X20)	3002609
	black	PTTB 4-HESI/LED 60 (5X20)	3211890	 PT 4-PE/L/HESI (5X20)	3002602
	black	PTTB 4-HESI/LED 250 (5X20)	3211892	 PT 4-PE/L/HESI/LED 24 (5X20)	3002603
	black			PT 4-PE/L/HESI/LED 60 (5X20)	3002604
	black			PT 4-PE/L/HESI/LED 250 (5X20)	3002605
Width / Length / Height	[mm]	6.2 / 102.9 / 75.5		6.2 / 118.5 / 83.9	6.2 / 118.5 / 83.9
Current / voltage // UL	[A] / [V]	28 // 500 / 20 / 600		28 // 500 / 20 / 600	30 // 500 / 20 / 600
rigid / AWG // flexible / AWG	[mm ²] / [-]	0.2 - 6 / 24 - 10 // 0.2 - 4 / 24 - 12		0.2 - 6 / 24 - 10 // 0.2 - 4 / 24 - 10	0.2 - 6 / 24 - 10 // 0.2 - 4 / 24 - 10
Stranded with ferrule without / with plastic sleeve	[mm ²]	0.25 - 4 / 0.25 - 4		0.25 - 4 / 0.25 - 4	0.25 - 4 / 0.25 - 4
Directly pluggable: with ferrule / rigid	[mm ²]	0.5 - 4 / 0.5 - 6		0.5 - 4 / 0.5 - 6	0.5 - 4 / 0.5 - 6
	black	PT 6-HESI (6,3X32)	3211870	PT 6-FSI/C	3212166
	black	PT 6-HESI/LED 24 (6,3X32)	3211874	PT 6-FSI/C-LED 12	3212169
	black	PT 6-HESI/LED 60 (6,3X32)	3211868	PT 6-FSI/C-LED 24	3212172
	black	PT 6-HESI/LED 250 (6,3X32)	3212133	PT 6-FSI/C-LED 48	3212175
Width / Length / Height	[mm]	8.2 / 74.5 / 69		8.2 / 74.1 / 45.5	12.3 / 77.7 / 51.2
Current / voltage // UL	[A] / [V]	10 // 630 / 10 / 600		25 // 400 / 25 / 600	10 // 1,000 / 10 / 600
rigid / AWG // flexible / AWG	[mm ²] / [-]	0.5 - 10 / 20 - 8 // 0.5 - 6 / 20 - 10		0.5 - 10 / 20 - 8 // 0.5 - 6 / 20 - 10	0.5 - 10 / 20 - 8 // 0.5 - 6 / 20 - 10
Stranded with ferrule without / with plastic sleeve	[mm ²]	0.5 - 6 / 0.5 - 6		0.5 - 6 / 0.5 - 6	0.5 - 6 / 0.5 - 6
Directly pluggable: with ferrule / rigid	[mm ²]	1 - 6 / 1 - 10		1 - 6 / 1 - 10	1 - 6 / 1 - 10











PT terminal blocks

					
	gray gray	PT 4-L/L PT 4-L	3002615 3002616		
Width / Length / Height Current / voltage // UL rigid / AWG // flexible / AWG Stranded with ferrule without / with plastic sleeve Directly pluggable: with ferrule / rigid	[mm] [A] / [V] [mm²] / [-] [mm²] [mm²]	6.2 / 118.5 / 56 30 // 500 / 20 / 600 0.2 - 6 / 24 - 10 // 0.2 - 4 / 24 - 10 0.25 - 4 / 0.25 - 4 0.5 - 4 / 0.5 - 6			
Mini terminal blocks					
	gray blue green-yellow	MPT 1,5/S MPT 1,5/S BU MPT 1,5/S-PE	3248100 3248101 3248110	MPT 2,5 MPT 2,5 BU MPT 2,5-PE	3248125 3248126 3248130
Width / Length / Height Current / voltage // UL rigid / AWG // flexible / AWG Stranded with ferrule without / with plastic sleeve Directly pluggable: with ferrule / rigid	[mm] [A] / [V] [mm²] / [-] [mm²] [mm²]	3.5 / 33.55 / 28.1 17.5 // 500 / 15 / 600 0.14 - 1.5 / 26 - 14 // 0.14 - 1.5 / 26 - 14 0.14 - 1.5 / 0.14 - 1 0.34 - 1.5 / 0.25 - 1.5		5.2 / 36 / 34.8 24 // 500 / 20 / 600 0.14 - 4 / 26 - 12 // 0.14 - 2.5 / 26 - 14 0.14 - 2.5 / 0.14 - 2.5 0.34 - 2.5 / 0.34 - 4	
Fuse, diode and disconnect terminal blocks for 1000 V photovoltaic applications					
	black black	PT 10,3-HESI 1000V PTCL 16-HESILED 1000V	3062142 3062145		
Width / Length / Height Current / voltage // UL rigid / AWG // flexible / AWG Stranded with ferrule without / with plastic sleeve Directly pluggable: with ferrule / rigid	[mm] [A] / [V] [mm²] / [-] [mm²] [mm²]	17.6 / 87 / 63 20 // 1,000 / 32 / 1,000 1.5 - 10 / 16 - 6 // 1.5 - 10 / 14 - 6 1.5 - 10 / 1.5 - 10 4 - 10 / 1.5 - 10			
... L-R = diode conducting direction from left to right ... R-L = diode conducting direction from right to left ... BE = for soldering components in place					
	gray gray gray blue	PTME 6-DIO/L-R HV PTME 6-DIO/R-L HV PTME 6-BE	3035697 3035698 3035687	PTME 6 HV PTME 6 HV BU	3035696 3035695
Width / Length / Height Current / voltage // UL rigid / AWG // flexible / AWG Stranded with ferrule without / with plastic sleeve Directly pluggable: with ferrule / rigid	[mm] [A] / [V] [mm²] / [-] [mm²] [mm²]	8.2 / 100.8 / 60 5 // 1,000 / 10 / 600 0.5 - 10 / 20 - 8 // 0.5 - 6 / 20 - 10 0.5 - 6 / 0.5 - 6 1 - 6 / 1 - 10		8.2 / 100.8 / 49.6 30 // 1,000 / 30 / 600 0.5 - 10 / 20 - 8 // 0.5 - 6 / 20 - 10 0.5 - 6 / 0.5 - 6 1 - 6 / 1 - 10	



















PT terminal blocks

Diode terminal blocks							
	gray gray	PT 2,5-DIO/L-R PT 2,5-DIO/R-L	3210224 3210237	PT 2,5-TWIN-DIO/L-R PT 2,5-TWIN-DIO/R-L	3210240 3210253	PT 2,5-QUATTRO-DIO/L-R PT 2,5-QUATTRO-DIO/R-L	3210266 3210279
Width / Length / Height	[mm]	5.2 / 48.5 / 36.5	5.2 / 60.5 / 36.5	5.2 / 72 / 36.5			
Current / voltage // UL	[A] / [V]	0.5 // 800 / 20 / 300	0.5 // 800 / 20 / 300	0.5 // 800 / 20 / 300			
rigid / AWG // flexible / AWG	[mm ²] / [-]	0.14 - 4 / 26 - 12 // 0.14 - 2.5 / 26 - 14	0.14 - 4 / 26 - 12 // 0.14 - 2.5 / 26 - 14	0.14 - 4 / 26 - 12 // 0.14 - 2.5 / 26 - 14			
Stranded with ferrule without / with plastic sleeve	[mm ²]	0.14 - 2.5 / 0.14 - 2.5	0.14 - 2.5 / 0.14 - 2.5	0.14 - 2.5 / 0.14 - 2.5			
Directly pluggable: with ferrule / rigid	[mm ²]	0.34 - 2.5 / 0.34 - 4	0.34 - 2.5 / 0.34 - 4	0.34 - 2.5 / 0.34 - 4			
	gray gray	PT 4-DIO 1N 5408/L-R PT 4-DIO 1N 5408/R-L	3212112 3212125	PT 4-QUATTRO-DIO 1N 5408/L-R PT 4-QUATTRO-DIO 1N 5408/R-L	3211919 3211921	PTTB 2,5-DIO/O-U PTTB 2,5-DIO/U-O	3210923 3210936
Width / Length / Height	[mm]	6.2 / 56 / 36.5	6.2 / 77 / 36.5	5.2 / 68 / 47.5			
Current / voltage // UL	[A] / [V]	1.5 // 800 / 1.5 / 600	1.5 // 800 / 1.5 / 600	0.5 // 500 / 20 / 300			
rigid / AWG // flexible / AWG	[mm ²] / [-]	0.2 - 6 / 24 - 10 // 0.2 - 4 / 24 - 12	0.2 - 6 / 24 - 10 // 0.2 - 4 / 24 - 12	0.14 - 4 / 26 - 12 // 0.14 - 2.5 / 26 - 14			
Stranded with ferrule without / with plastic sleeve	[mm ²]	0.25 - 4 / 0.25 - 4	0.25 - 4 / 0.25 - 4	0.14 - 2.5 / 0.14 - 2.5			
Directly pluggable: with ferrule / rigid	[mm ²]	0.5 - 4 / 0.5 - 6	0.5 - 4 / 0.5 - 6	0.34 - 2.5 / 0.34 - 4			
	gray gray	PTTB 2,5-DIO/UL-UR	3211427	PTTB 2,5-2DIO/O-UL/UR-UL PTTB 2,5-2DIO/O-UL/O-UR	3211430 3211443	PTTB 2,5-R499/O-U	3210925
Width / Length / Height	[mm]	5.2 / 68 / 47.5	5.2 / 68 / 47.5	5.2 / 68 / 47.5			
Current / voltage // UL	[A] / [V]	0.5 // 500 / 20 / 300	0.5 // 500 / 20 / 300	20 // 500 / - / -			
rigid / AWG // flexible / AWG	[mm ²] / [-]	0.14 - 4 / 26 - 12 // 0.14 - 2.5 / 26 - 14	0.14 - 4 / 26 - 12 // 0.14 - 2.5 / 26 - 14	0.14 - 4 / 26 - 12 // 0.14 - 2.5 / 26 - 14			
Stranded with ferrule without / with plastic sleeve	[mm ²]	0.14 - 2.5 / 0.14 - 2.5	0.14 - 2.5 / 0.14 - 2.5	0.14 - 2.5 / 0.14 - 2.5			
Directly pluggable: with ferrule / rigid	[mm ²]	0.34 - 2.5 / 0.34 - 4	0.34 - 2.5 / 0.34 - 4	0.34 - 2.5 / 0.34 - 4			
	gray	PTTB 2,5-2BE	3211480				
Width / Length / Height	[mm]	5.2 / 68 / 47.5					
Current / voltage // UL	[A] / [V]	22 // 500					
rigid / AWG // flexible / AWG	[mm ²] / [-]	0.14 - 4 / 26 - 12 // 0.14 - 2.5 / 26 - 14					
Stranded with ferrule without / with plastic sleeve	[mm ²]	0.14 - 2.5 / 0.14 - 2.5					
Directly pluggable: with ferrule / rigid	[mm ²]	0.34 - 2.5 / 0.34 - 4					



PT terminal blocks

Hybrid terminal blocks with screw connection on one side							
Rated data for second connection technology at www.phoenixcontact.net/products							
	gray blue green-yellow	PTU 2,5 PTU 2,5 BU PTU 2,5-PE	3209519 3209520 3209521	PTU 2,5-TWIN PTU 2,5-TWIN BU PTU 2,5-TWIN-PE	3209515 3209516 3209517	PTU 4 PTU 4 BU PTU 4-PE	3211855 3211856 3211857
Width / Length / Height	[mm]	5.2 / 53.5 / 42.8		5.2 / 65.3 / 42.8		6.2 / 58.8 / 42.8	
Current / voltage // UL	[A] / [V]	24 // 800 / 20 / 600		24 // 800 / - / -		32 // 800 / 30 / 600	
rigid / AWG // flexible / AWG	[mm²] / [-]	0.14 - 4 / 26 - 12 // 0.14 - 2.5 / 26 - 14		0.14 - 4 / 26 - 12 // 0.14 - 2.5 / 26 - 14		0.2 - 6 / 24 - 10 // 0.2 - 4 / 24 - 12	
Stranded with ferrule without / with plastic sleeve	[mm²]	0.14 - 2.5 / 0.14 - 2.5		0.14 - 2.5 / 0.14 - 2.5		0.25 - 4 / 0.25 - 4	
Directly pluggable: with ferrule / rigid	[mm²]	0.34 - 2.5 / 0.34 - 4		0.34 - 2.5 / 0.34 - 4		0.5 - 4 / 0.5 - 6	
Rated data for second connection technology at www.phoenixcontact.net/products							
	gray gray blue green-yellow	PTU 4-TWIN PTU 4-TWIN BU PTU 4-TWIN-PE	3211859 3211860 3211862	PTU 4-MT PTU 4-MT-P	3209538 3209532	PTU 4-MTD PTU 4-MTD-P	3209539 3209540
Width / Length / Height	[mm]	6.2 / 69.3 / 42.8		6.2 / 71 / 42.8		6.2 / 71 / 42.8	
Current / voltage // UL	[A] / [V]	32 // 800 / 30 / 600		20 // 400 / - / -		20 // 400 / - / -	
rigid / AWG // flexible / AWG	[mm²] / [-]	0.2 - 6 / 24 - 10 // 0.2 - 4 / 24 - 12		0.2 - 6 / 24 - 10 // 0.2 - 4 / 24 - 12		0.2 - 6 / 24 - 10 // 0.2 - 4 / 24 - 12	
Stranded with ferrule without / with plastic sleeve	[mm²]	0.25 - 4 / 0.25 - 4		0.25 - 4 / 0.25 - 4		0.25 - 4 / 0.25 - 4	
Directly pluggable: with ferrule / rigid	[mm²]	0.5 - 4 / 0.5 - 6		0.5 - 4 / 0.5 - 6		0.5 - 4 / 0.5 - 6	
Rated data for second connection technology at www.phoenixcontact.net/products							
	gray gray	PTU 4-TG PTU 4-TG-P	3209542 3209541				
Width / Length / Height	[mm]	6.2 / 71 / 42.8					
Current / voltage // UL	[A] / [V]	20 // 400					
rigid / AWG // flexible / AWG	[mm²] / [-]	0.2 - 6 / 24 - 10 // 0.2 - 4 / 24 - 12					
Stranded with ferrule without / with plastic sleeve	[mm²]	0.25 - 4 / 0.25 - 4					
Directly pluggable: with ferrule / rigid	[mm²]	0.5 - 4 / 0.5 - 6					
Terminal blocks in desk design							
	gray blue green-yellow	PTS 1,5/S PTS 1,5/S BU PTS 1,5/S-PE	3214547 3214550 3214563	PTS 2,5 PTS 2,5 BU PTS 2,5-PE	3211799 3211812 3211867	PTS 4 PTS 4 BU PTS 4-PE	3213601 3213602 3213603
Width / Length / Height	[mm]	3.5 / 50.7 / 38.5		5.2 / 49 / 43		6.2 / 62.4 / 43	
Current / voltage // UL	[A] / [V]	17.5 // 500 / 15 / 600		24 // 800 / 20 / 600		32 // 800 / 30 / 600	
rigid / AWG // flexible / AWG	[mm²] / [-]	0.14 - 1.5 / 26 - 14 // 0.14 - 1.5 / 26 - 14		0.14 - 4 / 26 - 12 // 0.14 - 2.5 / 26 - 14		0.2 - 6 / 24 - 10 // 0.2 - 4 / 24 - 12	
Stranded with ferrule without / with plastic sleeve	[mm²]	0.14 - 1.5 / 0.14 - 1		0.14 - 2.5 / 0.14 - 2.5		0.25 - 4 / 0.25 - 4	
Directly pluggable: with ferrule / rigid	[mm²]	0.34 - 1.5 / 0.25 - 1.5		0.34 - 2.5 / 0.34 - 4		0.5 - 4 / 0.5 - 6	

PT terminal blocks

							
	gray blue green-yellow	PTS 1,5/S-TWIN PTS 1,5/S-TWIN BU PTS 1,5/S-TWIN-PE	3214589 3214592 3214602	PTS 2,5-TWIN PTS 2,5-TWIN BU PTS 2,5-TWIN-PE	3211896 3211906 3211935	PTS 4-TWIN PTS 4-TWIN BU PTS 4-TWIN-PE	3213604 3213605 3213606
Width / Length / Height	[mm]	3.5 / 50.7 / 38.5		5.2 / 49 / 43		6.2 / 62.4 / 43	
Current / voltage // UL	[A] / [V]	17.5 // 500 / 15 / 600		24 // 800 / 20 / 600		32 // 800 / 30 / 600	
rigid / AWG // flexible / AWG	[mm ²] / [-]	0.14 - 1.5 / 26 - 14 // 0.14 - 1.5 / 26 - 14		0.14 - 4 / 26 - 12 // 0.14 - 2.5 / 26 - 14		0.2 - 6 / 24 - 10 // 0.2 - 4 / 24 - 12	
Stranded with ferrule without / with plastic sleeve	[mm ²]	0.14 - 1.5 / 0.14 - 1		0.14 - 2.5 / 0.14 - 2.5		0.25 - 4 / 0.25 - 4	
Directly pluggable: with ferrule / rigid	[mm ²]	0.34 - 1.5 / 0.25 - 1.5		0.34 - 2.5 / 0.34 - 4		0.5 - 4 / 0.5 - 6	
							
	gray blue green-yellow	PTS 1,5/S-QUATTRO PTS 1,5/S-QUATTRO BU PTS 1,5/S-QUATTRO-PE	3214615 3214631 3214644	PTS 2,5-QUATTRO PTS 2,5-QUATTRO BU PTS 2,5-QUATTRO-PE	3211993 3212002 3212011	PTS 4-QUATTRO PTS 4-QUATTRO BU PTS 4-QUATTRO-PE	3213607 3213608 3213609
Width / Length / Height	[mm]	3.5 / 50.7 / 38.5		5.2 / 49 / 43		6.2 / 62.4 / 43	
Current / voltage // UL	[A] / [V]	17.5 // 500 / 15 / 600		24 // 800 / 20 / 600		32 // 800 / 30 / 600	
rigid / AWG // flexible / AWG	[mm ²] / [-]	0.14 - 1.5 / 26 - 14 // 0.14 - 1.5 / 26 - 14		0.14 - 4 / 26 - 12 // 0.14 - 2.5 / 26 - 14		0.2 - 6 / 24 - 10 // 0.2 - 4 / 24 - 12	
Stranded with ferrule without / with plastic sleeve	[mm ²]	0.14 - 1.5 / 0.14 - 1		0.14 - 2.5 / 0.14 - 2.5		0.25 - 4 / 0.25 - 4	
Directly pluggable: with ferrule / rigid	[mm ²]	0.34 - 1.5 / 0.25 - 1.5		0.34 - 2.5 / 0.34 - 4		0.5 - 4 / 0.5 - 6	
							
	gray gray gray blue green-yellow	PTTBS 1,5/S PTTBS 1,5/S-PV PTTBS 1,5/S BU PTTBS 1,5/S-PE	3214657 3214686 3214660 3214673	PTTBS 2,5 PTTBS 2,5-PV PTTBS 2,5-LA 24 RD PTTBS 2,5 BU PTTBS 2,5-PE	3209604 3210211 3245969 3209617 3209620	PTTBS 4 PTTBS 4-PV PTTBS 4 BU PTTBS 4-PE	3211832 3211848 3211838 3211841
Width / Length / Height	[mm]	3.5 / 78.8 / 48.2		5.2 / 78 / 55		6.2 / 96 / 54.5	
Current / voltage // UL	[A] / [V]	16 // 500 / 15 / 600		22 // 500 / 20 / 300		28 // 800 / 24 / 600	
rigid / AWG // flexible / AWG	[mm ²] / [-]	0.14 - 1.5 / 26 - 14 // 0.14 - 1.5 / 26 - 14		0.14 - 4 / 26 - 12 // 0.14 - 2.5 / 26 - 14		0.2 - 6 / 24 - 10 // 0.2 - 4 / 24 - 12	
Stranded with ferrule without / with plastic sleeve	[mm ²]	0.14 - 1.5 / 0.14 - 1		0.14 - 2.5 / 0.14 - 2.5		0.25 - 4 / 0.25 - 4	
Directly pluggable: with ferrule / rigid	[mm ²]	0.34 - 1.5 / 0.25 - 1.5		0.34 - 2.5 / 0.34 - 4		0.5 - 4 / 0.5 - 6	
Potential collective terminals							
							
	gray gray blue blue black/yellow	PT 2X10/9X4 PT 2X10/9X4 BU	3002369 3002368	PTU 35/4X10 PTU 35/4X6/6X2,5 PTU 35/4X10 BU PTU 35/4X6/6X2,5 BU PTU 35/4X6/6X2,5-FE	3002371 3214080 3002370 3214081 3214082		
Width / Length / Height	[mm]	18.5 / 83.2 / 47.9		19.4 / 79.9 / 50.3			
Current / voltage // UL	[A] / [V]	57 // 800 / 50 / 1,000		101 // 1,000 / 86 / 600			
rigid / AWG // flexible / AWG	[mm ²] / [-]	0.5 - 16 / 20 - 6 // 0.5 - 10 / 20 - 8		10 - 35 / 8 - 2 // 10 - 35 / 8 - 2			
Stranded with ferrule without / with plastic sleeve	[mm ²]	0.5 - 10 / 0.5 - 10		10 - 35 / 10 - 35			
Directly pluggable: with ferrule / rigid	[mm ²]	4 - 10 / 1 - 16		- / 1 - 16			

PT terminal blocks

Pick-off terminals							
	gray blue green-yellow green/yellow	AGK PT 4X6/M10 AGK PT 4X6/M10 BU AGK PT 4X6/M10 GNYE	1017448 1083237 1083238	AGK PT 8X6/M10 AGK PT 8X6/M10 BU AGK PT 8X6/M10 GNYE	1017450 1083235 1083236	AGK PT 4X6/M12	1017454
Width / Length / Height	[mm]	31 / 57.4 / 32.3	31 / 72.6 / 32.3	31 / 57.4 / 32.3			
Current / voltage // UL	[A] / [V]	41 // 1,000 / 100 / 1,000	41 // 1,000 / 100 / 1,000	41 // 1,000 / 100 / 1,000			
rigid / AWG // flexible / AWG	[mm²] / [-]	0.5 - 10 / 20 - 8 // 0.5 - 6 / 20 - 10	0.5 - 10 / 20 - 8 // 0.5 - 6 / 20 - 10	0.5 - 10 / 20 - 8 // 0.5 - 6 / 20 - 10			
Stranded with ferrule without / with plastic sleeve	[mm²]	0.5 - 6 / 0.5 - 6	0.5 - 6 / 0.5 - 6	0.5 - 6 / 0.5 - 6			

Push-in vertical – PTV terminal blocks with lateral conductor connection

Thanks to the lateral conductor routing, the PTV terminal blocks ensure clearly arranged wiring without bend radii. Thanks to the straight conductor routing from the terminal through to the cable duct, attaching and reading off wire markings is easier.

And the connection markings are easier to see.



Self-explanatory connection

Easy, direct, and self-explanatory connection, thanks to the combination of the Push-in connection with the vertical wiring direction of the screw terminal block.

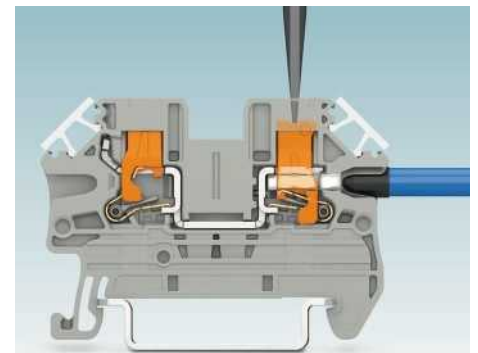

User-friendly connection

Thanks to Push-in technology, conductors with a cross section of 0.25 mm² and larger can be connected without tools.

Smaller conductors up to 0.25 mm² can be connected easily by operating the push button.

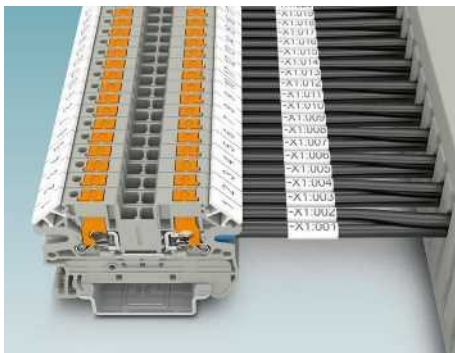
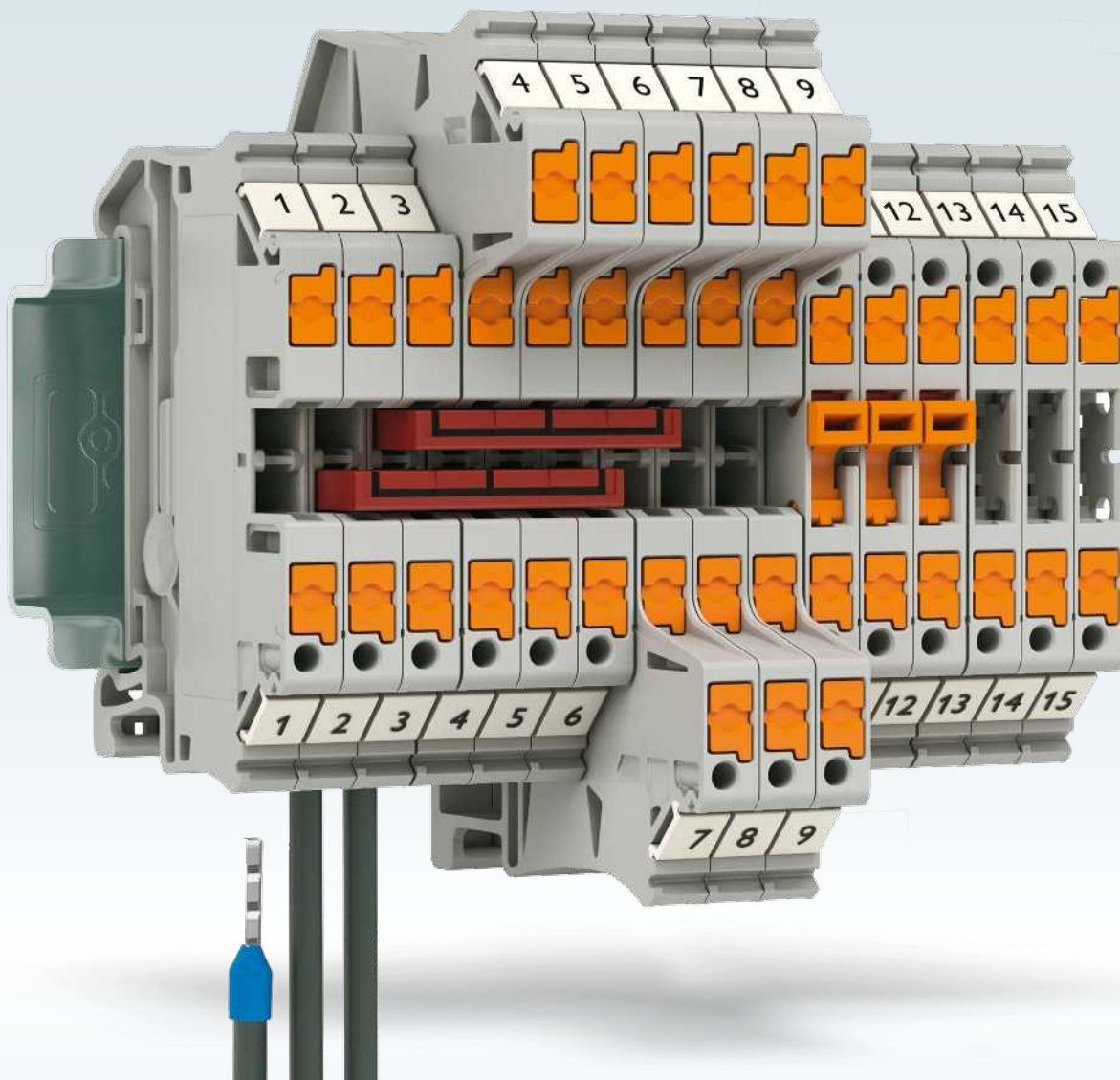

Clearly arranged wiring

The wiring direction of the PTV terminal blocks enables clearly arranged wiring without bend radii. This ensures that the connection markings are clearly visible.

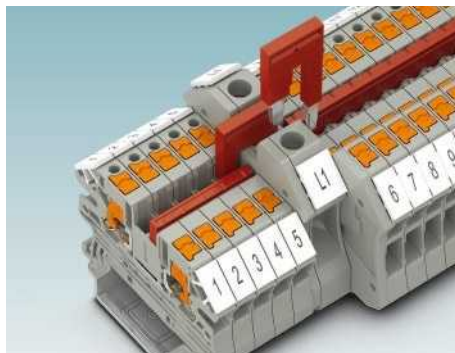

Standardized bridging system



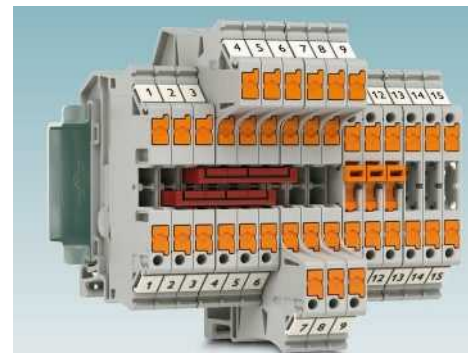

Thanks to the uniform accessories of the CLIPLINE complete system, FBS ... standard bridges and RB ... reducing bridges can be used for potential distribution.



Additional test points

All PTV terminal blocks have an additional test contact for test plugs with a 2.3 mm diameter.

PTV terminal blocks with lateral conductor connection

Feed-through terminal blocks				
	gray blue green-yellow	PTV 2,5 BU PTV 2,5-PE	PTV 2,5-TWIN BU PTV 2,5-TWIN-PE	PTV 2,5-QUATTRO BU PTV 2,5-QUATTRO-PE
		1078960 1078962 1078963	1078966 1078971 1078991	1078999 1079006 1079012
Width / Length / Height	[mm]	5.2 / 50.8 / 36.5	5.2 / 60 / 46.9	5.2 / 69.2 / 46.9
Current / voltage // UL	[A] / [V]	24 // 800	24 // 800	24 // 800
rigid / AWG // flexible / AWG	[mm ²] / [-]	0.14 - 4 / 26 - 12 // 0.14 - 2.5 / 26 - 14	0.14 - 4 / 26 - 12 // 0.14 - 2.5 / 26 - 14	0.14 - 4 / 26 - 12 // 0.14 - 2.5 / 26 - 14
Stranded with ferrule without / with plastic sleeve	[mm ²]	0.14 - 2.5 / 0.14 - 2.5	0.14 - 2.5 / 0.14 - 2.5	0.14 - 2.5 / 0.14 - 2.5
Directly pluggable: with ferrule / rigid	[mm ²]	0.34 - 2.5 / 0.34 - 4	0.34 - 2.5 / 0.34 - 4	0.34 - 2.5 / 0.34 - 4
Disconnect and knife disconnect terminal blocks				
	gray blue	PTVC 2,5-TG	PTVC 2,5-MT PTVC 2,5-MT BU	
		1079061	1079059 1079060	
Width / Length / Height	[mm]	5.2 / 62 / 36.5	5.2 / 62 / 36.5	
Current / voltage // UL	[A] / [V]	20 // 400	20 // 400	
rigid / AWG // flexible / AWG	[mm ²] / [-]	0.14 - 4 / 26 - 12 // 0.14 - 2.5 / 26 - 14	0.14 - 4 / 26 - 12 // 0.14 - 2.5 / 26 - 14	
Stranded with ferrule without / with plastic sleeve	[mm ²]	0.14 - 2.5 / 0.14 - 2.5	0.14 - 2.5 / 0.14 - 2.5	
Directly pluggable: with ferrule / rigid	[mm ²]	0.34 - 2.5 / 0.34 - 4	0.34 - 2.5 / 0.34 - 4	

Quick, easy and reliable – PTPOWER high-current terminal blocks

PTPOWER spring high-current terminal blocks enable you to wire conductors of up to 185 mm² and 309 A quickly, safely, and easily – thanks to unique Power Turn connection technology.

Compact design versions are available for DIN rail and direct mounting.

 Web code: #0158



Power-Turn Technology

The Power-Turn spring connection technology enables large conductors to be connected quickly and reliably with a single lever movement using a standard tool.



Easy testing

The terminal blocks are equipped with a two-sided test point for 2.3 mm standard test plugs. Versions with a 4 mm test point in the terminal block center are available for the use of 4 mm test plugs.



Easy, tool-free wiring

Quick and easy connection is also possible for large conductors. Alternatively, conductors can be quickly and easily inserted directly when the lever is closed thanks to Push-in technology.

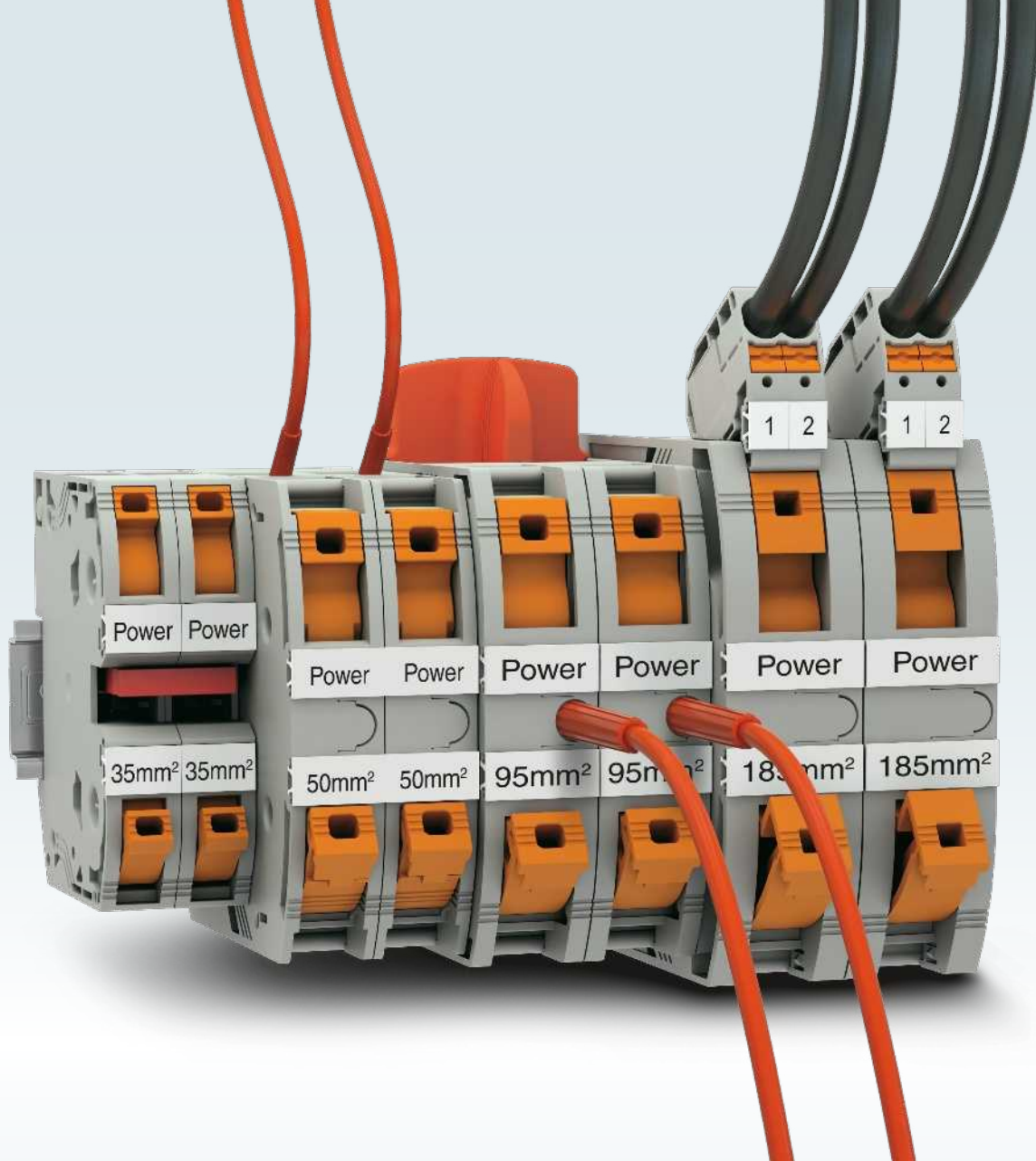

Safe pick-off

With the fully isolated pick-off terminal block, available in a snap-on version as an option, you can easily achieve your voltage pick-off for two conductors up to 16 mm². With a large marking area and integrated 2.3 mm test point.









Easy potential distribution

Distribute your potentials with isolated insertion bridges. They can be installed easily without any tools and latch securely in the clamping space.

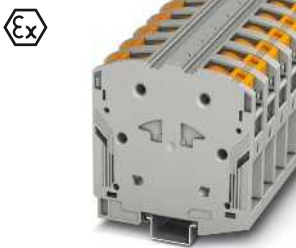









Functional blocks

Pre-assembled terminal blocks reduce mounting and storage costs. The right terminal block for DIN rail or direct mounting is available for every function.

PTPOWER high-current terminal blocks

High-current terminal blocks and blocks for DIN rail mounting							
	gray gray blue blue green-yellow black/yellow	PTPOWER 35 PTPOWER 35 P PTPOWER 35 BU PTPOWER 35 P BU PTPOWER 35-PE PTPOWER 35-FE	3212064 3212091 3212065 3212092 3212066 3212081	PTPOWER 50 PTPOWER 50 P PTPOWER 50 BU PTPOWER 50 P BU PTPOWER 50-PE PTPOWER 50-FE	3260050 3260065 3260051 3260066 3260052 3260063	PTPOWER 95 PTPOWER 95 P PTPOWER 95 BU PTPOWER 95 P BU PTPOWER 95-PE PTPOWER 95-FE	3260100 3260163 3260103 3260166 3260106 3260139
Width / Length / Height	[mm]	16 / 91.6 / 69.8	20 / 101 / 105	25 / 105.5 / 108.7			
Current / voltage // UL	[A] / [V]	125 // 1,000 / 115 / 1,000	150 // 1,000 / 140 / 1,000	232 // 1,000 / 230 / 1,000			
rigid / AWG // flexible / AWG	[mm ²] / [-]	2.5 - 35 / 12 - 2 // 2.5 - 35 / 12 - 2	10 - 70 / 8 - 2/0 // 10 - 70 / 8 - 2/0	25 - 95 / 4 - 4/0 // 25 - 95 / 4 - 4/0			
Stranded with ferrule without / with plastic sleeve	[mm ²]	2.5 - 35 / 2.5 - 35	10 - 50 / 10 - 50	25 - 95 / 25 - 95			
Directly pluggable: with ferrule / rigid	[mm ²]	2.5 - 35 / 2.5 - 35	10 - 50 / 10 - 70	25 - 95 / 25 - 95			
							
	gray gray blue blue black/yellow gray/blue gray/black-yellow gray/blue/black-yellow	PTPOWER 185 PTPOWER 185 P PTPOWER 185 BU PTPOWER 185 P BU PTPOWER 185-FE	1054722 1054725 1054723 1054726 1054724	PTPOWER 35-3L PTPOWER 35-3L/N PTPOWER 35-3L/FE PTPOWER 35-3L/N/FE	3212068 3212069 3212070 3212071	PTPOWER 50-3L PTPOWER 50-3L/N PTPOWER 50-3L/FE PTPOWER 50-3L/N/FE	3260053 3260054 3260055 3260056
Width / Length / Height	[mm]	31 / 116.4 / 116.5	48 / 91.6 / 69.8	60 / 101 / 105			
Current / voltage // UL	[A] / [V]	309 // 1,500 / 290 / 1,000	125 // 1,000 / 115 / 1,000	150 // 1,000 / 140 / 1,000			
rigid / AWG // flexible / AWG	[mm ²] / [-]	95 - 185 / 3/0 - 350 kcmil // 95 - 185 / 3/0 - 350 kcmil	2.5 - 35 / 12 - 2 // 2.5 - 35 / 12 - 2	10 - 70 / 8 - 2/0 // 10 - 70 / 8 - 2/0			
Stranded with ferrule without / with plastic sleeve	[mm ²]	95 - 150 / 95 - 150	2.5 - 35 / 2.5 - 35	10 - 50 / 10 - 50			
Directly pluggable: with ferrule / rigid	[mm ²]	95 - 150 / 95 - 185	2.5 - 35 / 2.5 - 35	10 - 50 / 10 - 70			
							
	gray gray/blue gray/black-yellow gray/blue/black-yellow	PTPOWER 95-3L PTPOWER 95-3L/N PTPOWER 95-3L/FE PTPOWER 95-3L/N/FE	3260109 3260112 3260115 3260118	PTPOWER 185-3L PTPOWER 185-3L/N PTPOWER 185-3L/FE PTPOWER 185-3L/N/FE	1054728 1054729 1054730 1054731		
Width / Length / Height	[mm]	75 / 105.5 / 108.7	93 / 116.4 / 108.7				
Current / voltage // UL	[A] / [V]	232 // 1,000 / 230 / 1,000	309 // 1,500 / 290 / 1,000				
rigid / AWG // flexible / AWG	[mm ²] / [-]	25 - 95 / 4 - 4/0 // 25 - 95 / 4 - 4/0	95 - 185 / 3/0 - 350 kcmil // 95 - 185 / 3/0 - 350 kcmil				
Stranded with ferrule without / with plastic sleeve	[mm ²]	25 - 95 / 25 - 95	95 - 150 / 95 - 150				
Directly pluggable: with ferrule / rigid	[mm ²]	25 - 95 / 25 - 95	95 - 150 / 95 - 185				

PTPOWER high-current terminal blocks

High-current terminal blocks and blocks for direct mounting							
							
	gray blue black/yellow	PTPOWER 35-F PTPOWER 35-F BU PTPOWER 35-FE-F	3212078 3212079 3212082	PTPOWER 50-F PTPOWER 50-F BU PTPOWER 50-FE-F	3260061 3260062 3260064	PTPOWER 95-F PTPOWER 95-F BU PTPOWER 95-FE-F	3260133 3260136 3260142
Width / Length / Height	[mm]	16 / 120.2 / 68.3		20 / 101 / 96		25 / 139.1 / 99.8	
Current / voltage // UL	[A] / [V]	125 // 1,000 / 115 / 1,000		150 // 1,000 / 140 / 1,000		232 // 1,000 / 230 / 1,000	
rigid / AWG // flexible / AWG	[mm ²] / [-]	2.5 - 35 / 12 - 2 // 2.5 - 35 / 12 - 2		10 - 70 / 8 - 2/0 // 10 - 70 / 8 - 2/0		25 - 95 / 4 - 4/0 // 25 - 95 / 4 - 4/0	
Stranded with ferrule without / with plastic sleeve	[mm ²]	2.5 - 35 / 2.5 - 35		10 - 50 / 10 - 50		25 - 95 / 25 - 95	
Directly pluggable: with ferrule / rigid	[mm ²]	2.5 - 35 / 2.5 - 35		10 - 50 / 10 - 70		25 - 95 / 25 - 95	
							
	gray blue black/yellow gray/blue gray/black-yellow gray/blue/black-yellow	PTPOWER 185 F PTPOWER 185 F BU PTPOWER 185 FE-F	1054732 1054733 1054734	PTPOWER 35-3L-F PTPOWER 35-3L/N-F PTPOWER 35-3L/FE-F PTPOWER 35-3L/N/FE-F	3212072 3212073 3212075 3212076	PTPOWER 50-3L-F PTPOWER 50-3L/N-F PTPOWER 50-3L/FE-F PTPOWER 50-3L/N/FE-F	3260057 3260058 3260059 3260060
Width / Length / Height	[mm]	31 / 150 / 108.3		48 / 120.2 / 68.3		60 / 101 / 96	
Current / voltage // UL	[A] / [V]	309 // 1,500 / 290 / 1,000		125 // 1,000 / 115 / 1,000		150 // 1,000 / 140 / 1,000	
rigid / AWG // flexible / AWG	[mm ²] / [-]	95 - 185 / 3/0 - 350 kcmil // 95 - 185 / 3/0 - 350 kcmil		2.5 - 35 / 12 - 2 // 2.5 - 35 / 12 - 2		10 - 70 / 8 - 2/0 // 10 - 70 / 8 - 2/0	
Stranded with ferrule without / with plastic sleeve	[mm ²]	95 - 150 / 95 - 150		2.5 - 35 / 2.5 - 35		10 - 50 / 10 - 50	
Directly pluggable: with ferrule / rigid	[mm ²]	95 - 150 / 95 - 185		2.5 - 35 / 2.5 - 35		10 - 50 / 10 - 70	
							
	gray gray/blue gray/black-yellow gray/blue/black-yellow blue green/yellow black/yellow	PTPOWER 95-3L-F PTPOWER 95-3L/N-F PTPOWER 95-3L/FE-F PTPOWER 95-3L/N/FE-F	3260121 3260124 3260127 3260130	PTPOWER 185 3L-F PTPOWER 185 3L/N-F PTPOWER 185 3L/FE-F PTPOWER 185 3L/N/FE-F	1054735 1054736 1054737 1054738	AGK 10-PTPOWER AGK 10-PTPOWER BU AGK 10-PTPOWER GN/YE AGK 10-PTPOWER BK/YE	3260145 3260148 3260151 3260154
Width / Length / Height	[mm]	75 / 139.1 / 99.8		93 / 150 / 108.3		18.5 / 35 / 34.7	
Current / voltage // UL	[A] / [V]	232 // 1,000 / 230 / 1,000		309 // 1,500 / 290 / 1,000		57 // 1,500 / 57 / 1,000	
rigid / AWG // flexible / AWG	[mm ²] / [-]	25 - 95 / 4 - 4/0 // 25 - 95 / 4 - 4/0		95 - 185 / 3/0 - 350 kcmil // 95 - 185 / 3/0 - 350 kcmil		0.5 - 16 / 20 - 6 // 0.5 - 10 / 20 - 8	
Stranded with ferrule without / with plastic sleeve	[mm ²]	25 - 95 / 25 - 95		95 - 150 / 95 - 150		0.5 - 10 / 0.5 - 10	
Directly pluggable: with ferrule / rigid	[mm ²]	25 - 95 / 25 - 95		95 - 150 / 95 - 185		4 - 10 / 1 - 16	

Compact and flexible – PTIO sensor/actuator terminal blocks

Wire sensors and actuators in modern machine and system controllers easily and clearly using compact sensor and actuator terminal blocks with a terminal width of 3.5 mm.

All PTIO terminal blocks feature the same shape and can be consistently bridged with the CLIPLINE complete plug-in bridge system for maximum flexibility.

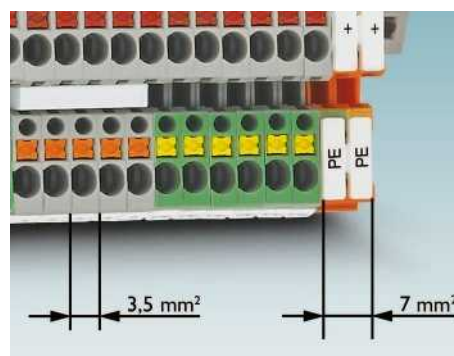

Compact design

PTIO terminal blocks enable the connection of bipolar two-conductor and three-conductor sensors and actuators to a terminal width of 3.5 mm.

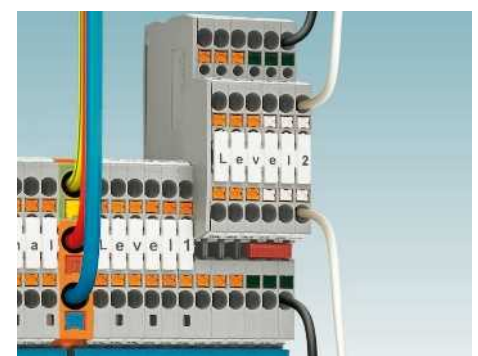

Bipolar wiring

The PTIO 1,5/S/5... range includes a version with black-white push buttons. This color-coding is in accordance with standard EN 60947-5-2 and enables better assignment of the conductors.

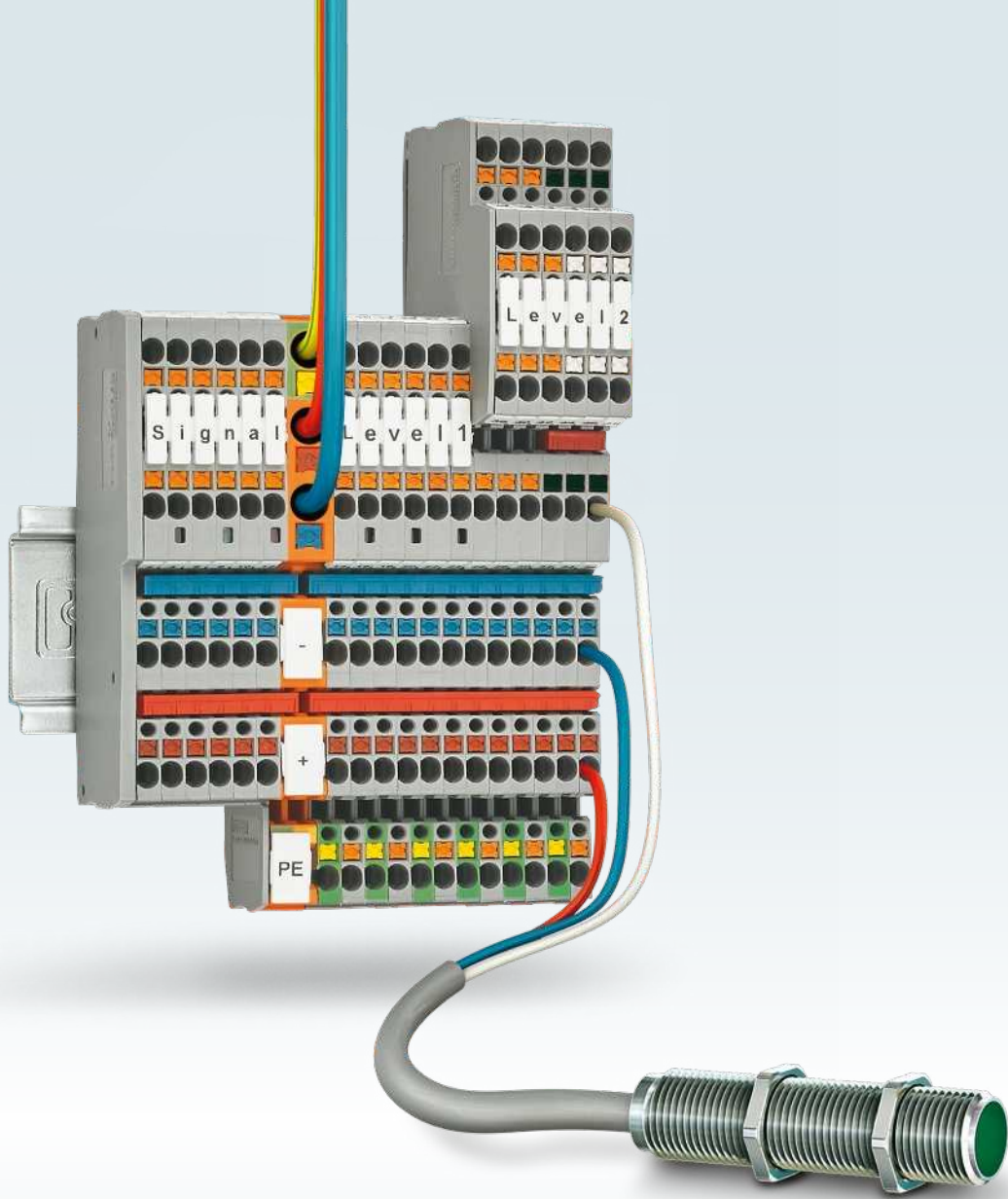

Flexible feed-in and bridging

Feed-in terminals of the same shape enable convenient potential distribution and the simple expansion of terminal block groups.

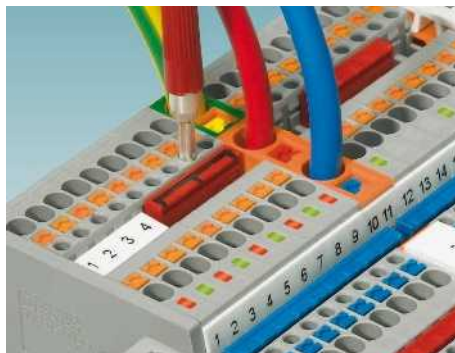

Clear assignment



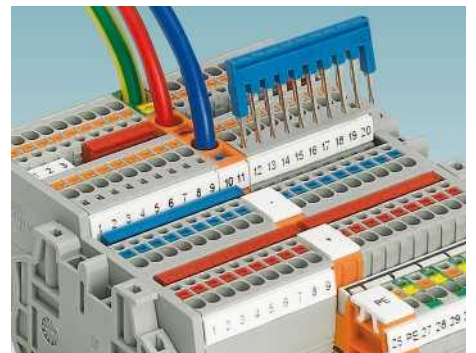





LED indicator versions are available for unique switching state signaling.



Clear marking

Large labels can be used on the signal level for a better overview.

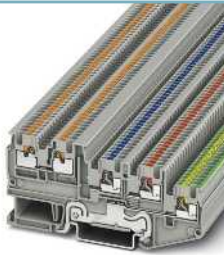
PTIO sensor/actuator terminal blocks

Three-conductor initiator/actuator terminal blocks				
	gray gray	PTIO 1,5/S/3 3244410	PTIO 1,5/S/3-LED 24 RD PTIO 1,5/S/3-LED 24 GN 3244423 3244436	PTIO 1,5/S/3-PE 3244449
Width / Length / Height	[mm]	3.5 / 74.4 / 41.5	3.5 / 74.4 / 41.5	3.5 / 74.4 / 41.5
Current / voltage // UL	[A] / [V]	13.5 // 250 / 15 / 300	13.5 // 250 / 15 / 300	13.5 // 250 / - / -
rigid / AWG // flexible / AWG	[mm ²] / [-]	0.14 - 1.5 / 26 - 14 // 0.14 - 1.5 / 26 - 14	0.14 - 1.5 / 26 - 14 // 0.14 - 1.5 / 26 - 14	0.14 - 1.5 / 26 - 14 // 0.14 - 1.5 / 26 - 14
Stranded with ferrule without / with plastic sleeve	[mm ²]	0.14 - 1.5 / 0.14 - 1	0.14 - 1.5 / 0.14 - 1	0.14 - 1.5 / 0.14 - 1
Directly pluggable: with ferrule / rigid	[mm ²]	0.34 - 1.5 / 0.25 - 1.5	0.34 - 1.5 / 0.25 - 1.5	0.34 - 1.5 / 0.25 - 1.5
				
	orange	PTIO-IN 2,5/3 OG 3244559		
Width / Length / Height	[mm]	7 / 74.4 / 41.5		
Current / voltage // UL	[A] / [V]	20 // 250 / 16 / 300		
rigid / AWG // flexible / AWG	[mm ²] / [-]	0.2 - 4 / 24 - 12 // 0.2 - 2.5 / 24 - 14		
Stranded with ferrule without / with plastic sleeve	[mm ²]	0.2 - 2.5 / 0.2 - 2.5		
Directly pluggable: with ferrule / rigid	[mm ²]	0.34 - 2.5 / 0.34 - 4		
Four-conductor initiator/actuator terminal blocks				
	gray gray	PTIO 1,5/S/4 3244452	PTIO 1,5/S/4-LED 24 RD PTIO 1,5/S/4-LED 24 GN 3244517 3244520	PTIO 1,5/S/4-PE 3244465
Width / Length / Height	[mm]	3.5 / 90.8 / 41.5	3.5 / 90.8 / 41.5	3.5 / 90.8 / 41.5
Current / voltage // UL	[A] / [V]	13.5 // 250 / 15 / 300	13.5 // 250 / 15 / 300	13.5 // 250 / - / -
rigid / AWG // flexible / AWG	[mm ²] / [-]	0.14 - 1.5 / 26 - 14 // 0.14 - 1.5 / 26 - 14	0.14 - 1.5 / 26 - 14 // 0.14 - 1.5 / 26 - 14	0.14 - 1.5 / 26 - 14 // 0.14 - 1.5 / 26 - 14
Stranded with ferrule without / with plastic sleeve	[mm ²]	0.14 - 1.5 / 0.14 - 1	0.14 - 1.5 / 0.14 - 1	0.14 - 1.5 / 0.14 - 1
Directly pluggable: with ferrule / rigid	[mm ²]	0.34 - 1.5 / 0.25 - 1.5	0.34 - 1.5 / 0.25 - 1.5	0.34 - 1.5 / 0.25 - 1.5
				
	orange	PTIO-IN 2,5/4-PE OG 3244481		
Width / Length / Height	[mm]	7 / 90.8 / 41.5		
Current / voltage // UL	[A] / [V]	20 // 250		
rigid / AWG // flexible / AWG	[mm ²] / [-]	0.2 - 4 / 24 - 12 // 0.2 - 2.5 / 24 - 14		
Stranded with ferrule without / with plastic sleeve	[mm ²]	0.2 - 2.5 / 0.2 - 2.5		
Directly pluggable: with ferrule / rigid	[mm ²]	0.34 - 2.5 / 0.34 - 4		

PTIO sensor/actuator terminal blocks

Five-conductor initiator/actuator terminal blocks				
	gray	PTIO 1,5/S/5 3244470	PTIO 1,5/S/5-PE 3244473	PTIO 1,5/S/5-U-BK/O-WH 3244472
Width / Length / Height	[mm]	3.5 / 121.65 / 52.1	3.5 / 121.65 / 52.1	3.5 / 121.65 / 52.1
Current / voltage // UL	[A] / [V]	13.5 // 250 / 15 / 500	13.5 // 250 / 15 / 500	13.5 // 250 / - / -
rigid / AWG // flexible / AWG	[mm ²] / [-]	0.14 - 1.5 / 26 - 14 // 0.14 - 1.5 / 26 - 14	0.14 - 1.5 / 26 - 14 // 0.14 - 1.5 / 26 - 14	0.14 - 1.5 / 26 - 14 // 0.14 - 1.5 / 26 - 14
Stranded with ferrule without / with plastic sleeve	[mm ²]	0.14 - 1.5 / 0.14 - 1	0.14 - 1.5 / 0.14 - 1	0.14 - 1.5 / 0.14 - 1
Directly pluggable: with ferrule / rigid	[mm ²]	0.34 - 1.5 / 0.25 - 1.5	0.34 - 1.5 / 0.25 - 1.5	0.34 - 1.5 / 0.25 - 1.5
	gray	 PTIO 1,5/S/5-PE-U-BK/O-WH 3244471		
Width / Length / Height	[mm]	3.5 / 121.65 / 52.1		
Current / voltage // UL	[A] / [V]	13.5 // 250 / 15 / 500		
rigid / AWG // flexible / AWG	[mm ²] / [-]	0.14 - 1.5 / 26 - 14 // 0.14 - 1.5 / 26 - 14		
Stranded with ferrule without / with plastic sleeve	[mm ²]	0.14 - 1.5 / 0.14 - 1		
Directly pluggable: with ferrule / rigid	[mm ²]	0.34 - 1.5 / 0.25 - 1.5		

Compact and functional – PT disconnect and knife disconnect terminal blocks

The compact disconnect terminal blocks with an overall width of 3.5 mm enable knife disconnection for conductors up to 1.5 mm². You can therefore achieve space savings of up to 30% in the control cabinet.

Alongside compact disconnect terminal blocks, Phoenix Contact provides powerful disconnect terminal blocks up to 16 mm² and 1000 V. This diversity enables you to use the appropriate knife disconnection in every application.

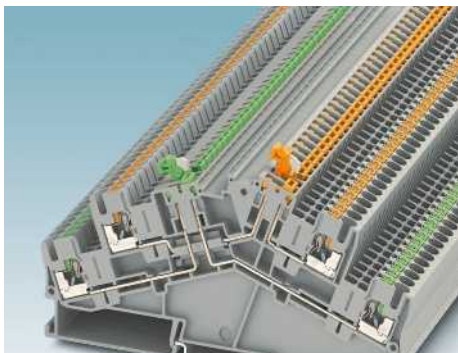

Clear color coding

Disconnect knives and push buttons of the same color provide clear assignment of the connection levels when there are two disconnect levels.

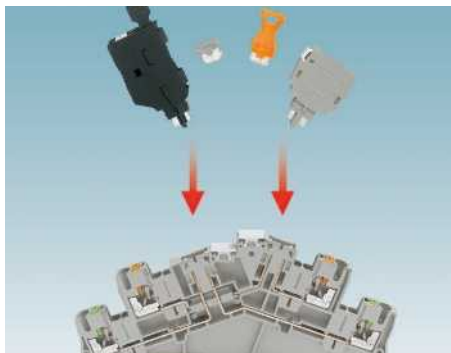

Multifunctional disconnect zone

In the range of 2.5 mm² terminal blocks, double-level disconnect terminal blocks with universal disconnect zones are available. This zone accommodates fuse plugs, component connectors, and isolating plugs.



Easy operation

The actuation cross on the disconnect knife enables the use of screwdrivers of different sizes.

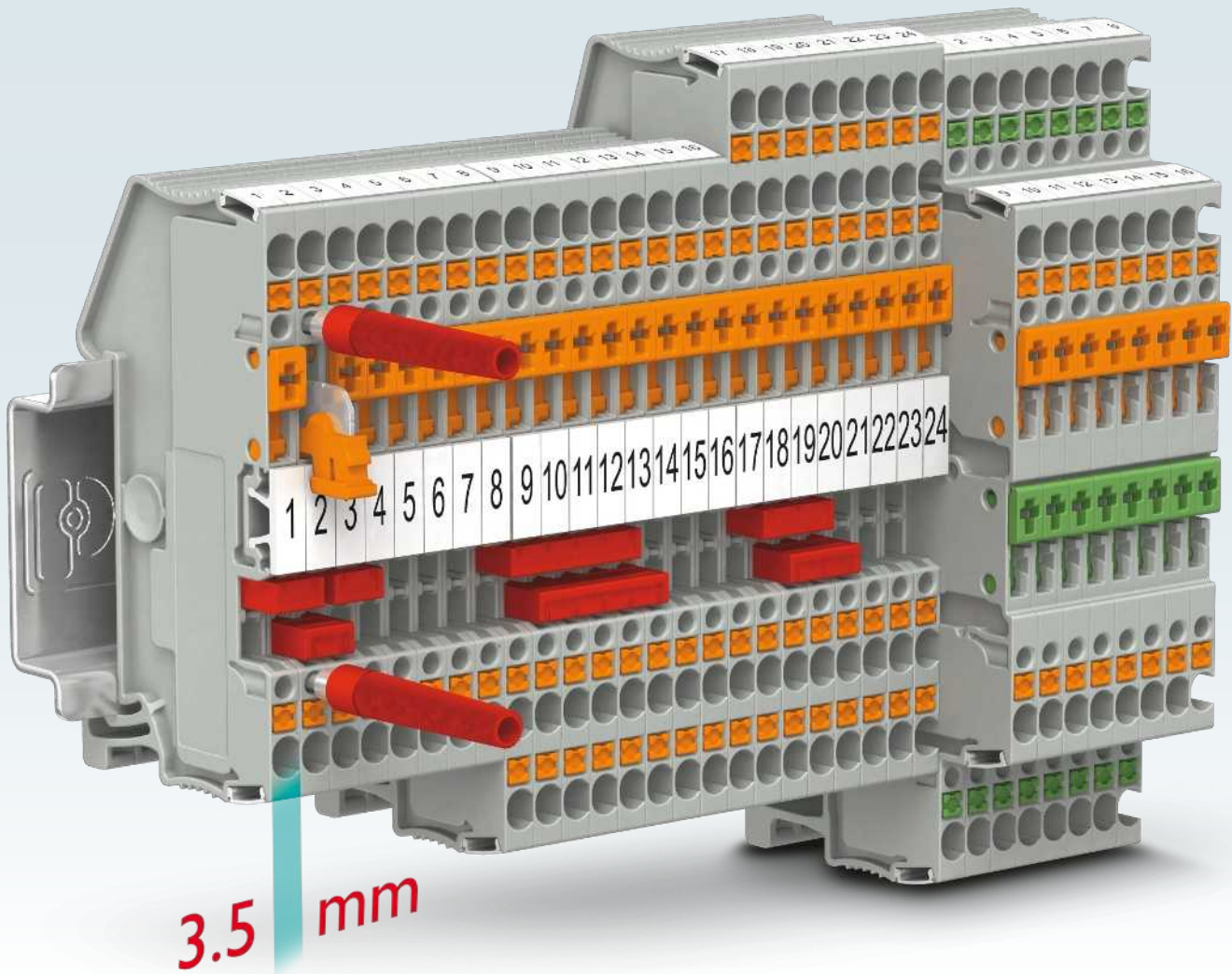

3.5 mm

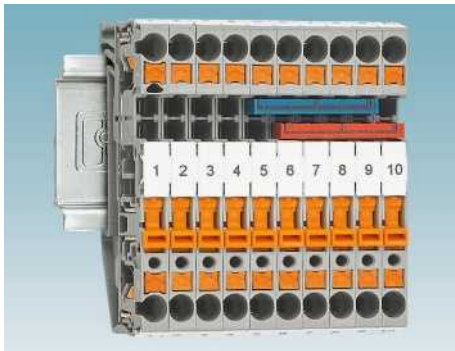

Easy potential distribution

Potentials can be distributed effortlessly thanks to the standardized bridge accessories and the consistent function shaft of the CLIPLINE complete system.

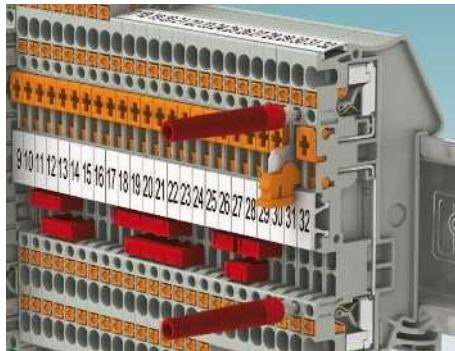

Additional test contacts

All terminal blocks feature an additional test contact on both sides of the disconnect point for test plugs with a 2.3 mm diameter.

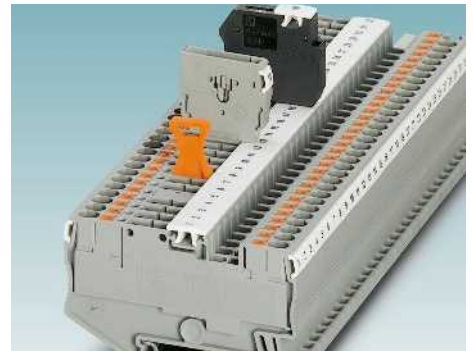

Large-surface labeling

Large labels can be used on the signal level for a better overview.

PT disconnect and knife disconnect terminal blocks

Disconnect terminal blocks for accommodating function plugs				
	gray	PTC 2,5-TG 3270088	PTC 2,5-TWIN-TG 3270091	PTC 2,5-QUATTRO-TG 3270094
Width / Length / Height	[mm]	5.2 / 56 / 36.5	5.2 / 67.8 / 36.5	5.2 / 79.6 / 36.5
Current / voltage // UL	[A] / [V]	20 // 400 / 15 / 300	20 // 400 / 15 / 300	20 // 400 / 15 / 300
rigid / AWG // flexible / AWG	[mm ²] / [-]	0.14 - 4 / 26 - 12 // 0.14 - 2.5 / 26 - 14	0.14 - 4 / 26 - 12 // 0.14 - 2.5 / 26 - 14	0.14 - 4 / 26 - 12 // 0.14 - 2.5 / 26 - 14
Stranded with ferrule without / with plastic sleeve	[mm ²]	0.14 - 2.5 / 0.14 - 2.5	0.14 - 2.5 / 0.14 - 2.5	0.14 - 2.5 / 0.14 - 2.5
Directly pluggable: with ferrule / rigid	[mm ²]	0.34 - 2.5 / 0.34 - 4	0.34 - 2.5 / 0.34 - 4	0.34 - 2.5 / 0.34 - 4
	gray	PT 2,5-TG 3210185	PT 2,5-TWIN-TG 3210198	PT 2,5-QUATTRO-TG 3210208
Width / Length / Height	[mm]	5.2 / 62 / 36.5	5.2 / 74 / 36.5	5.2 / 84 / 36.5
Current / voltage // UL	[A] / [V]	20 // 400 / 20 / 600	20 // 400 / 20 / 600	20 // 400 / 20 / 600
rigid / AWG // flexible / AWG	[mm ²] / [-]	0.14 - 4 / 26 - 12 // 0.14 - 2.5 / 26 - 14	0.14 - 4 / 26 - 12 // 0.14 - 2.5 / 26 - 14	0.14 - 4 / 26 - 12 // 0.14 - 2.5 / 26 - 14
Stranded with ferrule without / with plastic sleeve	[mm ²]	0.14 - 2.5 / 0.14 - 2.5	0.14 - 2.5 / 0.14 - 2.5	0.14 - 2.5 / 0.14 - 2.5
Directly pluggable: with ferrule / rigid	[mm ²]	0.34 - 2.5 / 0.34 - 4	0.34 - 2.5 / 0.34 - 4	0.34 - 2.5 / 0.34 - 4
	gray	PT 2,5-TGB 3210192	PT 2,5-TWIN-TGB 3210193	PT 2,5-QUATTRO-TGB 3210194
Width / Length / Height	[mm]	5.2 / 70.1 / 36.8	5.2 / 81.9 / 36.7	5.2 / 92.2 / 36.7
Current / voltage // UL	[A] / [V]	16 // 400 / 20 / 600	16 // 400 / 20 / 600	16 // 400 / 20 / 600
rigid / AWG // flexible / AWG	[mm ²] / [-]	0.14 - 4 / 26 - 12 // 0.14 - 2.5 / 26 - 14	0.14 - 4 / 26 - 12 // 0.14 - 2.5 / 26 - 14	0.14 - 4 / 26 - 12 // 0.14 - 2.5 / 26 - 14
Stranded with ferrule without / with plastic sleeve	[mm ²]	0.14 - 2.5 / 0.14 - 2.5	0.14 - 2.5 / 0.14 - 2.5	0.14 - 2.5 / 0.14 - 2.5
Directly pluggable: with ferrule / rigid	[mm ²]	0.34 - 2.5 / 0.34 - 4	0.34 - 2.5 / 0.34 - 4	0.34 - 2.5 / 0.34 - 4
	gray gray orange	PT 4-TG 3211922	 PT 4-PE/L/TG 3002618	PT 6-TG 3212163 PT 6-T P/P HV 1028589 PT 6-T P/P HV OG 1068179
Width / Length / Height	[mm]	6.2 / 56 / 36.5	6.2 / 119.5 / 56	8.2 / 74.1 / 45.3
Current / voltage // UL	[A] / [V]	20 // 500 / 20 / 400	30 // 500 / 20 / 600	20 // 500 / 20 / 600
rigid / AWG // flexible / AWG	[mm ²] / [-]	0.2 - 6 / 24 - 10 // 0.2 - 4 / 24 - 12	0.2 - 6 / 24 - 10 // 0.2 - 4 / 24 - 10	0.5 - 10 / 20 - 8 // 0.5 - 6 / 20 - 10
Stranded with ferrule without / with plastic sleeve	[mm ²]	0.25 - 4 / 0.25 - 4	0.25 - 4 / 0.25 - 4	0.5 - 6 / 0.5 - 6
Directly pluggable: with ferrule / rigid	[mm ²]	0.5 - 4 / 0.5 - 6	0.5 - 4 / 0.5 - 6	1 - 6 / 1 - 10

PT disconnect and knife disconnect terminal blocks

							
	gray blue	PTT 2,5-L/TG PTT 2,5-L/TG BU	3210230 3210270	PTTB 4-TG PTTB 4-TG BU	3211909 3211911	PTTBS 2,5-2TGB	3210402
Width / Length / Height	[mm]	5.2 / 92.4 / 47.4	6.2 / 102.9 / 47.4	5.2 / 127.5 / 64.3			
Current / voltage // UL	[A] / [V]	16 // 400 / 16 / 300	28 // 500 / 20 / 600	16 // 400 / 16 / 300			
rigid / AWG // flexible / AWG	[mm ²] / [-]	0.14 - 4 / 26 - 12 // 0.14 - 2.5 / 26 - 14	0.2 - 6 / 24 - 10 // 0.2 - 4 / 24 - 12	0.14 - 4 / 26 - 12 // 0.14 - 2.5 / 26 - 14			
Stranded with ferrule without / with plastic sleeve	[mm ²]	0.14 - 2.5 / 0.14 - 2.5	0.25 - 4 / 0.25 - 4	0.14 - 2.5 / 0.14 - 2.5			
Directly pluggable: with ferrule / rigid	[mm ²]	0.34 - 2.5 / 0.34 - 4	0.5 - 4 / 0.5 - 6	0.34 - 2.5 / 0.34 - 4			
Function plugs for disconnect terminal blocks							
							
	gray orange	P-FIX	P-DI	P-CO			
		3038956	3036783	3036796			
Width / Length / Height	[mm]	4 / 10.5 / -	3.5 / 10.8 / 23.1	5.1 / 24.2 / 33.3			
Current / voltage // UL	[A]	- // - / -	- // - / -	6 // - / -			
rigid / AWG // flexible / AWG	[-]	- // - / -	- // - / -	- // - / -			
							
	gray gray gray black	P-CO XL P-CO XL SKN P-CO XL-UT	P-CO 2-5 R47K	P-FU 5X20-5			
		3036797 3036798 3036799	3032447	3209235			
Width / Length / Height	[mm]	12.3 / 41.2 / 37.5	4.1 / 8.9 / 34.8	6.2 / 25 / 57.7			
Current / voltage // UL	[A] / [V]	10 // 400 / 7 / 300	- // - / - / -	6.3 // 400 / 10 / 300			
rigid / AWG // flexible / AWG	[-]	- // - / -	- // - / -	- // - / -			
							
	black black black	P-FU 5X20 LED 24-5 P-FU 5X20 LED 60-5 P-FU 5X20 LED 250-5	P-FU 5X20	P-FU 5X20 LED 24 P-FU 5X20 LED 60			
		3209248 3209251 3209264	3036806	3036819 3036822			
Width / Length / Height	[mm]	6.2 / 25 / 57.7	6.2 / 28 / 25	6.2 / 28 / 25			
Current / voltage // UL	[A] / [V]	6.3 // - / 10 / 24	6.3 // 500 / - / -	6.3 // - / - / -			
rigid / AWG // flexible / AWG	[-]	- // - / -	- // - / -	- // - / -			





PT disconnect and knife disconnect terminal blocks

				
	black	P-FU 5X20 LA 250	3036835	
Width / Length / Height Current / voltage // UL rigid / AWG // flexible / AWG	[mm] [A] / [V] [-]	6.2 / 28 / 25 6.3 // - / - - // -		
Knife disconnect terminal blocks				
				
	gray gray blue blue	PT 1,5/S-MT PT 1,5/S-MTD PT 1,5/S-MT BU PT 1,5/S-MTD BU	3210301 3210308 3210302 3210309	PT 1,5/S-TWIN-MT PT 1,5/S-TWIN-MTD PT 1,5/S-TWIN-MT BU PT 1,5/S-TWIN-MTD BU
Width / Length / Height Current / voltage // UL rigid / AWG // flexible / AWG Stranded with ferrule without / with plastic sleeve Directly pluggable: with ferrule / rigid	[mm] [A] / [V] [mm²] / [-] [mm²] [mm²]	3.5 / 58.9 / 32 10 // 400 / 10 / 300 0.14 - 1.5 / 26 - 14 // 0.14 - 1.5 / 26 - 14 0.14 - 1.5 / 0.14 - 1 0.34 - 1.5 / 0.25 - 1.5		3.5 / 67.8 / 32 10 // 400 / 10 / 300 0.14 - 1.5 / 26 - 14 // 0.14 - 1.5 / 26 - 14 0.14 - 1.5 / 0.14 - 1 0.34 - 1.5 / 0.25 - 1.5
				
	gray gray blue	PTC 2,5-MT PTC 2,5-MTD PTC 2,5-MTD BU	3270079 3270106 3270109	PTC 2,5-TWIN-MT PTC 2,5-TWIN-MTD PTC 2,5-TWIN-MTD BU
Width / Length / Height Current / voltage // UL rigid / AWG // flexible / AWG Stranded with ferrule without / with plastic sleeve Directly pluggable: with ferrule / rigid	[mm] [A] / [V] [mm²] / [-] [mm²] [mm²]	5.2 / 56 / 36.5 20 // 400 / 15 / 300 0.14 - 4 / 26 - 12 // 0.14 - 2.5 / 26 - 14 0.14 - 2.5 / 0.14 - 2.5 0.34 - 2.5 / 0.34 - 4		5.2 / 67.8 / 36.5 20 // 400 / 15 / 300 0.14 - 4 / 26 - 12 // 0.14 - 2.5 / 26 - 14 0.14 - 2.5 / 0.14 - 2.5 0.34 - 2.5 / 0.34 - 4
				
	gray blue	PT 2,5-MT PT 2,5-MT BU	3210156 3211650	PT 2,5-TWIN-MT PT 2,5-TWIN-MT BU
Width / Length / Height Current / voltage // UL rigid / AWG // flexible / AWG Stranded with ferrule without / with plastic sleeve Directly pluggable: with ferrule / rigid	[mm] [A] / [V] [mm²] / [-] [mm²] [mm²]	5.2 / 62 / 36.5 20 // 400 / 20 / 600 0.14 - 4 / 26 - 12 // 0.14 - 2.5 / 26 - 14 0.14 - 2.5 / 0.14 - 2.5 0.34 - 2.5 / 0.34 - 4		5.2 / 74 / 36.5 20 // 400 / 20 / 600 0.14 - 4 / 26 - 12 // 0.14 - 2.5 / 26 - 14 0.14 - 2.5 / 0.14 - 2.5 0.34 - 2.5 / 0.34 - 4
				
				PT 2,5-QUATTRO-MT PT 2,5-QUATTRO-MT BU
				3210172 3211676

PT disconnect and knife disconnect terminal blocks

				
	gray blue	PT 2,5-MTB PT 2,5-MTB BU	PT 2,5-TWIN-MTB PT 2,5-TWIN-MTB BU	PT 2,5-QUATTRO-MTB PT 2,5-QUATTRO-MTB BU
		3210157 3210163	3210170 3210177	3210184 3210191
Width / Length / Height	[mm]	5.2 / 70.1 / 36.7	5.2 / 81.9 / 36.7	5.2 / 92.2 / 36.7
Current / voltage // UL	[A] / [V]	16 // 400 / 20 / 600	16 // 400 / 20 / 600	16 // 400 / 20 / 600
rigid / AWG // flexible / AWG	[mm ²] / [-]	0.14 - 4 / 26 - 12 // 0.14 - 2.5 / 26 - 14	0.14 - 4 / 26 - 12 // 0.14 - 2.5 / 26 - 14	0.14 - 4 / 26 - 12 // 0.14 - 2.5 / 26 - 14
Stranded with ferrule without / with plastic sleeve	[mm ²]	0.14 - 2.5 / 0.14 - 2.5	0.14 - 2.5 / 0.14 - 2.5	0.14 - 2.5 / 0.14 - 2.5
Directly pluggable: with ferrule / rigid	[mm ²]	0.34 - 2.5 / 0.34 - 4	0.34 - 2.5 / 0.34 - 4	0.34 - 2.5 / 0.34 - 4
				
	gray	PT 4-MT	PT 4-PE/L/MT	PT 6-MT
		3211933	3002617	3212160
Width / Length / Height	[mm]	6.2 / 56 / 36.5	6.2 / 119.5 / 57.6	8.2 / 74.1 / 43.7
Current / voltage // UL	[A] / [V]	20 // 500 / 20 / 400	30 // 500 / 20 / 600	20 // 500 / 20 / 600
rigid / AWG // flexible / AWG	[mm ²] / [-]	0.2 - 6 / 24 - 10 // 0.2 - 4 / 24 - 12	0.2 - 6 / 24 - 10 // 0.2 - 4 / 24 - 10	0.5 - 10 / 20 - 8 // 0.5 - 6 / 20 - 10
Stranded with ferrule without / with plastic sleeve	[mm ²]	0.25 - 4 / 0.25 - 4	0.25 - 4 / 0.25 - 4	0.5 - 6 / 0.5 - 6
Directly pluggable: with ferrule / rigid	[mm ²]	0.5 - 4 / 0.5 - 6	0.5 - 4 / 0.5 - 6	1 - 6 / 1 - 10
				
	gray blue	PT 6-MT P/P HV	PT 10-MT	PTT 1,5/S-2L PTT 1,5/S-2L BU
		1028591	1073992	3210356 3210357
Width / Length / Height	[mm]	10.2 / 91 / 64.3	10.2 / 88.9 / 50.5	3.5 / 86 / 42.6
Current / voltage // UL	[A] / [V]	32 // 1,000 / - / -	20 // 500 / - / -	9 // 400 / 10 / 300
rigid / AWG // flexible / AWG	[mm ²] / [-]	0.5 - 10 / 20 - 8 // 0.5 - 6 / 20 - 10	0.5 - 16 / 20 - 6 // 0.5 - 16 / 20 - 8	0.14 - 1.5 / 26 - 14 // 0.14 - 1.5 / 26 - 14
Stranded with ferrule without / with plastic sleeve	[mm ²]	0.5 - 10 / 0.5 - 10	0.5 - 16 / 0.5 - 16	0.14 - 1.5 / 0.14 - 1
Directly pluggable: with ferrule / rigid	[mm ²]	1.5 - 6 / 1 - 10	1 - 16 / 1 - 16	0.34 - 1.5 / 0.25 - 1.5
				
	gray blue	PTT 1,5/S-L/MT PTT 1,5/S-L/MT BU	PTT 1,5/S-2MT PTT 1,5/S-2MT BU	PTT 2,5-2L PTT 2,5-2L BU
		3210341 3210342	3210351 3210352	3210267 3210268
Width / Length / Height	[mm]	3.5 / 86 / 42.6	3.5 / 86 / 42.6	5.2 / 92.4 / 47.4
Current / voltage // UL	[A] / [V]	9 // 400 / 10 / 300	9 // 400 / 10 / 300	16 // 400 / 16 / 300
rigid / AWG // flexible / AWG	[mm ²] / [-]	0.14 - 1.5 / 26 - 14 // 0.14 - 1.5 / 26 - 14	0.14 - 1.5 / 26 - 14 // 0.14 - 1.5 / 26 - 14	0.14 - 4 / 26 - 12 // 0.14 - 2.5 / 26 - 14
Stranded with ferrule without / with plastic sleeve	[mm ²]	0.14 - 1.5 / 0.14 - 1	0.14 - 1.5 / 0.14 - 1	0.14 - 2.5 / 0.14 - 2.5
Directly pluggable: with ferrule / rigid	[mm ²]	0.34 - 1.5 / 0.25 - 1.5	0.34 - 1.5 / 0.25 - 1.5	0.34 - 2.5 / 0.34 - 4

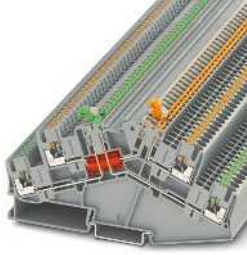
PT disconnect and knife disconnect terminal blocks

							
	gray blue	PTT 2,5-LMT PTT 2,5-LMT BU	3210251 3210257	PTT 2,5-2MT PTT 2,5-2MT BU	3210258 3210265	PTTB 4-MT PTTB 4-MT BU	3211913 3211915
Width / Length / Height	[mm]	5.2 / 92.4 / 47.4	5.2 / 92.4 / 47.4	6.2 / 102.9 / 49			
Current / voltage // UL	[A] / [V]	16 // 400 / 16 / 300	16 // 400 / 16 / 300	28 // 500 / 20 / 600			
rigid / AWG // flexible / AWG	[mm ²] / [-]	0.14 - 4 / 26 - 12 // 0.14 - 2.5 / 26 - 14	0.14 - 4 / 26 - 12 // 0.14 - 2.5 / 26 - 14	0.2 - 6 / 24 - 10 // 0.2 - 4 / 24 - 12			
Stranded with ferrule without / with plastic sleeve	[mm ²]	0.14 - 2.5 / 0.14 - 2.5	0.14 - 2.5 / 0.14 - 2.5	0.25 - 4 / 0.25 - 4			
Directly pluggable: with ferrule / rigid	[mm ²]	0.34 - 2.5 / 0.34 - 4	0.34 - 2.5 / 0.34 - 4	0.5 - 4 / 0.5 - 6			
							
	gray blue white	PTTBS 2,5-2MTB PTTBS 2,5-2MTB BU	3210400 3210401	S-MT	3247954		
Width / Length / Height	[mm]	5.2 / 127.5 / 64.3	3.5 / 10.5 / 23.1				
Current / voltage // UL	[A] / [V]	16 // 400 / 16 / 300	- / - / -				
rigid / AWG // flexible / AWG	[mm ²] / [-]	0.14 - 4 / 26 - 12 // 0.14 - 2.5 / 26 - 14	- / - / -				
Stranded with ferrule without / with plastic sleeve	[mm ²]	0.14 - 2.5 / 0.14 - 2.5	- / -				
Directly pluggable: with ferrule / rigid	[mm ²]	0.34 - 2.5 / 0.34 - 4	- / -				

Three-dimensional marshaling – PT four-level terminal blocks

PT 2.5-4 L four-level terminal blocks enable you to marshal signals in your controllers and system sections using minimal space.

Thanks to the different bridging options in the terminal strip and the bridging options in the 4-position plugs for free assembly, this terminal system enables extremely compact, three-dimensional signal distributors to be created.

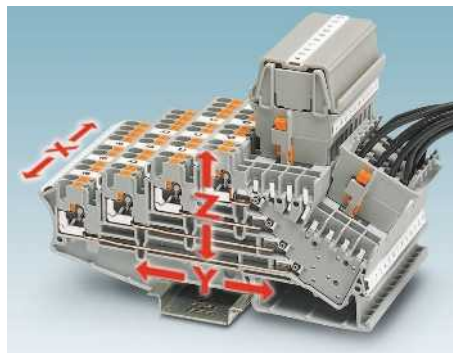

Increased modularity

The four-level terminal blocks equipped with two slots increase the modularity of the system by adding a marshaling level.



Flexible marshaling

The marshaling terminals enable the use of marshaling plugs for free assembly for horizontal, vertical, and diagonal signal wiring.

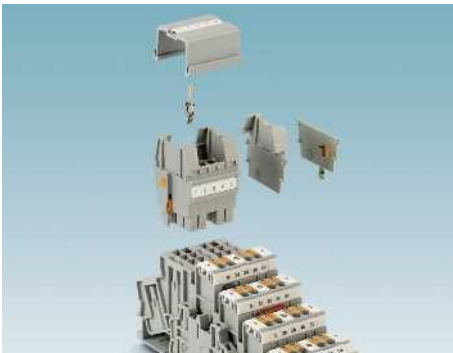
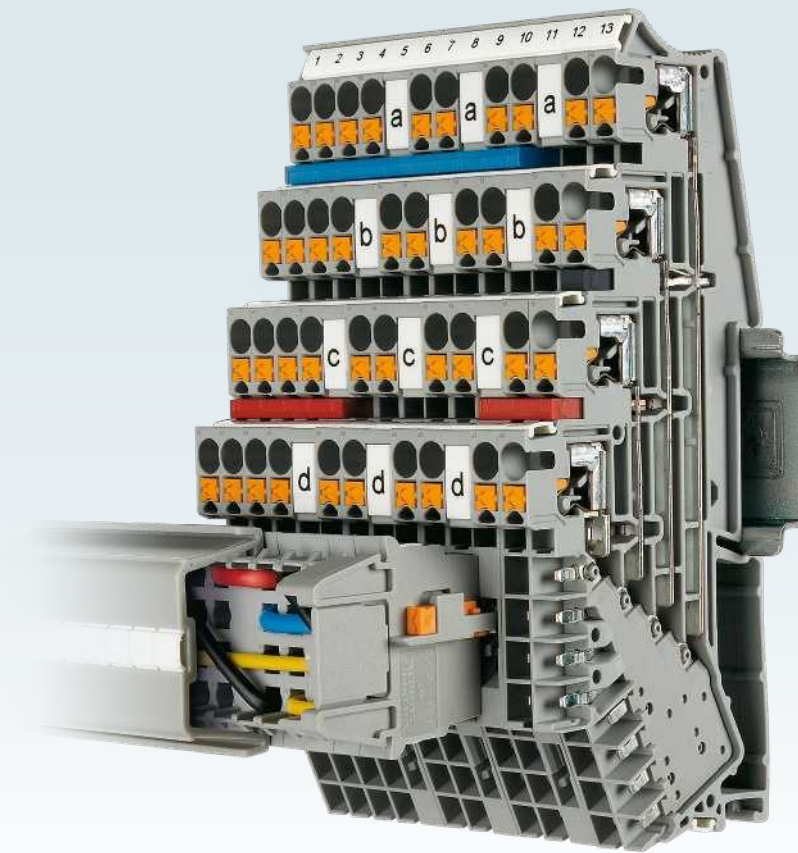

Modular design

The marshaling plug accessory features a modular design and can be assembled specifically for the application.



Easy horizontal potential distribution



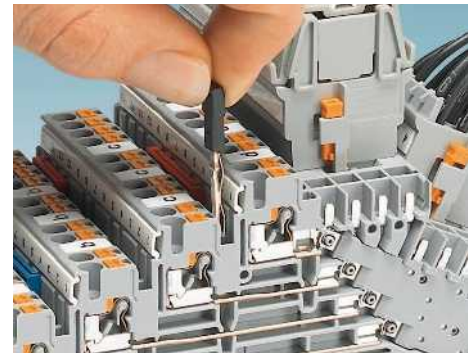

One function shaft is available for the cross connection of the potentials for each level.



Easy vertical potential distribution

The plug-in FBS-PV PT 2,5-4 L vertical bridge enables potential to be distributed easily between the levels of a terminal block.

PT four-level terminal blocks

Knife disconnect terminal blocks					
	gray gray	PT 2,5-4L/1P PT 2,5-4L/1P-F	3012300 3012326	PT 2,5-4L/2P PT 2,5-PE/3L/2P	3012310 3012316
Width / Length / Height	[mm]	5.2 / 105.6 / 59	5.2 / 125 / 59	5.2 / 125 / 59	
Current / voltage // UL	[A] / [V]	10 // 250 / 10 / 300	10 // 250 / 10 / 300	10 // 250 / 10 / 300	
rigid / AWG // flexible / AWG	[mm ²] / [-]	0.14 - 4 / 26 - 12 // 0.14 - 2.5 / 26 - 14	0.14 - 4 / 26 - 12 // 0.14 - 2.5 / 26 - 14	0.14 - 4 / 26 - 12 // 0.14 - 2.5 / 26 - 14	
Stranded with ferrule without / with plastic sleeve	[mm ²]	0.14 - 2.5 / 0.14 - 2.5	0.14 - 2.5 / 0.14 - 2.5	0.14 - 2.5 / 0.14 - 2.5	
Directly pluggable: with ferrule / rigid	[mm ²]	0.34 - 2.5 / 0.34 - 4	0.34 - 2.5 / 0.34 - 4	0.34 - 2.5 / 0.34 - 4	
					
	gray	CP-H 2,5-4L-PE	CP-H 2,5-4L		
		3012323	3012313		
Width / Length / Height	[mm]	5.2 / 31.6 / 31.7	5.2 / 31.6 / 31.7		
rigid / AWG // flexible / AWG	[-]	- // -	- // -		

Simple, reliable and intuitive marshaling – PTRV marshaling terminals

Marshal sensors and actuators easily and clearly with a compact solution.

The configurable color coding ensures quick orientation and safe wiring. Large label carriers that can be inserted individually enable matrix identification and provide the best possible overview in the control cabinet.

Potential distributors of the same shape and a comprehensive range of accessories complete the product range.

 **Web code:** #0160

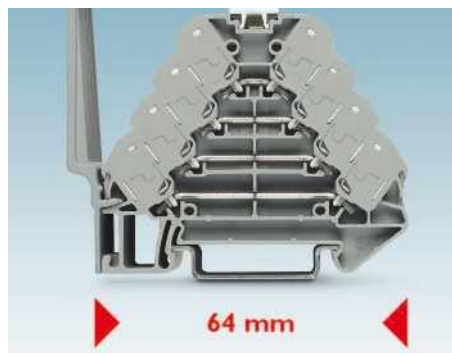

Compact marshaling

Maximize your signal density with the compact design of the marshaling terminals. Optional cabling duct combs that can be snapped on also reduce space and costs.

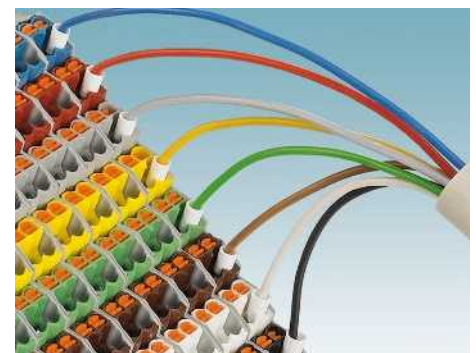

Intuitive and safe

The 11 freely configurable colors enable intuitive and safe installation. The color-coded assignment of conductors and terminal points is assured.

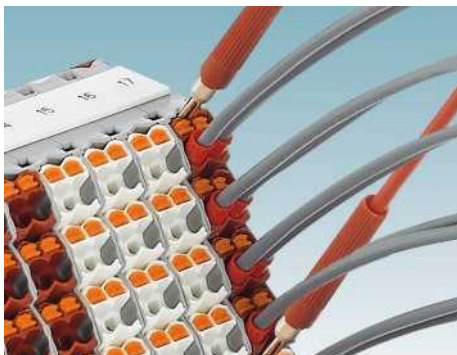

Easy testing

The freely accessible 2.3 mm test points are centered between the connection points. This enables you to conveniently test the marshaling terminals on every level.



Flexible marking









Large label carriers that can be inserted individually enable matrix identification and provide the best possible overview when wiring and testing.





Space-saving potential distribution

Potential distribution with up to 32 connections can be realized with the PTRVB ...-PV terminal blocks. They can be extended to potential distribution blocks via plug-in bridges for assembly.

PTRV marshaling terminals

Marshaling terminals and potential distributors						
						
gray/white gray/red blue/blue blue/white blue/red gray/black gray/black blue/black gray/yellow/black gray/black/yellow	PTRV 4 /WH PTRV 4 /RD PTRV 4 BU/BU PTRV 4 BU/WH PTRV 4 BU/RD	3270115 3270121 3270118 3270119 3270120	PTRV 4-PV /BK PTRV 4-PV BU/BK PTRV 4-FE /YEBK PTRV 4-FE /BKYE	3270125 3270126 3270130 3270131	PTRVB 4-FI /BK PTRVB 4-PV /BK	3270158 3270157
Width / Length / Height Current / voltage // UL rigid / AWG // flexible / AWG Stranded with ferrule without / with plastic sleeve Directly pluggable: with ferrule / rigid	[mm] [A] / [V] [mm²] / [-] [mm²] [mm²]	8.3 / 64 / 55.5 10 // 250 / 10 / 300 0.14 - 2.5 / 26 - 14 // 0.14 - 1.5 / 26 - 14 0.14 - 1.5 / 0.14 - 1.5 0.34 - 1.5 / 0.34 - 2.5	8.3 / 64 / 55.5 17.5 // 250 / 10 / 300 0.14 - 2.5 / 26 - 14 // 0.14 - 1.5 / 26 - 14 0.14 - 1.5 / 0.14 - 1.5 0.34 - 1.5 / 0.34 - 2.5	8.3 / 64 / 55.5 17.5 // 250 / 25 / 300 0.14 - 2.5 / 26 - 14 // 0.14 - 1.5 / 26 - 14 0.14 - 1.5 / 0.14 - 1.5 0.34 - 1.5 / 0.34 - 2.5		
						
gray/white/red blue/white/red blue/red/white blue/blue gray/red/white gray/black gray/black blue/black gray/yellow/black gray/black/yellow	PTRV 8 /WHRD PTRV 8 BU/WHRD PTRV 8 BU/RDWH PTRV 8 BU/BU PTRV 8 /RDWH	3270133 3270134 3270135 3270136 3270137	PTRV 8-PV /BK PTRV 8-PV BU/BK PTRV 8-FE /YEBK PTRV 8-FE /BKYE	3270142 3270145 3270148 3270149	PTRVB 8-FI /BK PTRVB 8-PV /BK	3270160 3270159
Width / Length / Height Current / voltage // UL rigid / AWG // flexible / AWG Stranded with ferrule without / with plastic sleeve Directly pluggable: with ferrule / rigid	[mm] [A] / [V] [mm²] / [-] [mm²] [mm²]	8.3 / 100 / 87.5 8 // 250 / 10 / 300 0.14 - 2.5 / 26 - 14 // 0.14 - 1.5 / 26 - 14 0.14 - 1.5 / 0.14 - 1.5 0.34 - 1.5 / 0.34 - 2.5	8.3 / 100 / 87.5 17.5 // 250 / 10 / 300 0.14 - 2.5 / 26 - 14 // 0.14 - 1.5 / 26 - 14 0.14 - 1.5 / 0.14 - 1.5 0.34 - 1.5 / 0.34 - 2.5	8.3 / 100 / 87.5 17.5 // 250 / 25 / 300 0.14 - 2.5 / 26 - 14 // 0.14 - 1.5 / 26 - 14 0.14 - 1.5 / 0.14 - 1.5 0.34 - 1.5 / 0.34 - 2.5		
						
gray white green-yellow	DP-PTRV 4	3270163	D-PTRV 4 WH A-D	3270153	PTRVB 4-PE	1070018
Width / Length / Height rigid / AWG // flexible / AWG Stranded with ferrule without / with plastic sleeve Directly pluggable: with ferrule / rigid	[mm] [mm²] / [-] [mm²] [mm²]	8.3 / 63.6 / 54 - / - / - / - - / - - / -	2.2 / 63.6 / 48.9 - / - / - / - - / - - / -	8.3 / 64 / 55.5 0.14 - 2.5 / 26 - 14 // 0.14 - 1.5 / 26 - 14 0.14 - 1.5 / 0.14 - 1.5 0.34 - 1.5 / 0.34 - 2.5		

PTRV marshaling terminals

Freely-configurable marshaling terminals					
	gray	PTRV 4 /COL-RD	3001754	PTRV 8 /COL-RDWH	3001851
	gray	PTRV 4 /COL-WH	3001871	PTRV 8 /COL-WHRD	3001876
	gray	PTRV 4 /RD-COL	3001872	PTRV 8 /RDWH-COL	3001877
	gray	PTRV 4 /WH-COL	3001874	PTRV 8 /WHRD-COL	3001878
	gray	PTRV 4 /COL-COL	3001875	PTRV 8 /COL-COL	3001879
Width / Length / Height	[mm]	8.3 / 64 / 55.5		8.3 / 100 / 87.5	
Current / voltage // UL	[A] / [V]	10 // 250 / 10 / 300		8 // 250 / 10 / 300	
rigid / AWG // flexible / AWG	[mm ²] / [-]	0.14 - 2.5 / 26 - 12 // 0.14 - 1.5 / 26 - 14		0.14 - 2.5 / 26 - 14 // 0.14 - 1.5 / 26 - 14	
Stranded with ferrule without / with plastic sleeve	[mm ²]	0.14 - 1.5 / 0.14 - 1.5		0.14 - 1.5 / 0.14 - 1.5	
Directly pluggable: with ferrule / rigid	[mm ²]	0.34 - 1.5 / 0.34 - 2.5		0.34 - 1.5 / 0.34 - 2.5	

Simple, reliable and intuitive marshaling – PTMC marshaling patchboards

Thanks to their design, the PTMC marshaling patchboards provide maximum signal density for marshaling in automation applications. The modular structure can be configured to the precise number of positions and features colored matrix elements. This ensures space-saving, clearly arranged, and error-free wiring.

 **Web code: #0161**



Modular design

The marshaling patchboards feature a modular design and the positions can be configured specifically tailored to the application. The elements latch in easily and securely.

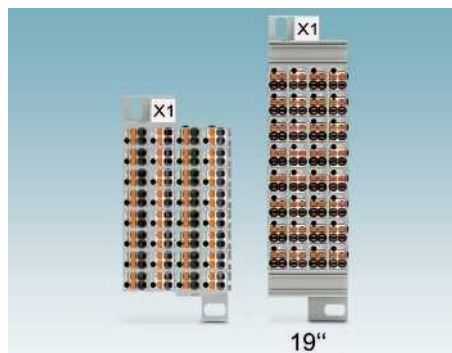

Space-saving design

Up to 20% higher signal density compared to 19-inch versions available on the market, thanks to its compact design.

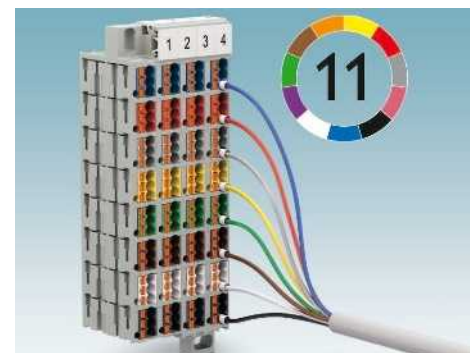

Intuitive and safe

The freely configurable color assignment for conductors and terminal points enables intuitive and safe installation.

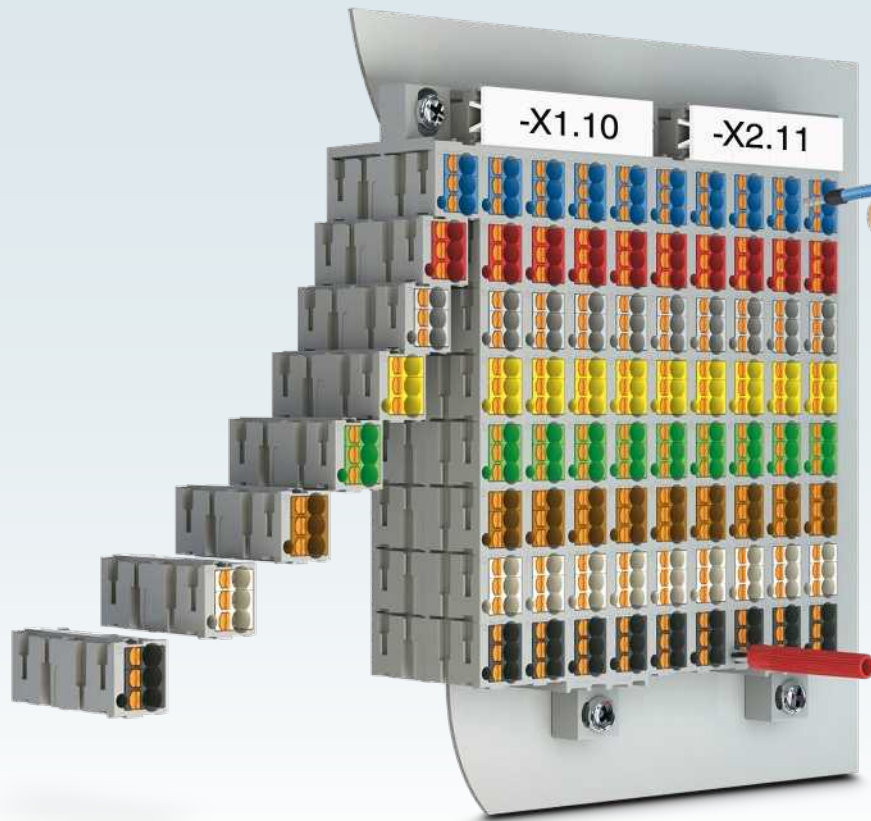

Flexible use

Along with direct mounting versions, adapters are available for DIN rail mounting. This enables them to be used in even the smallest machine housings or sub-distributors.

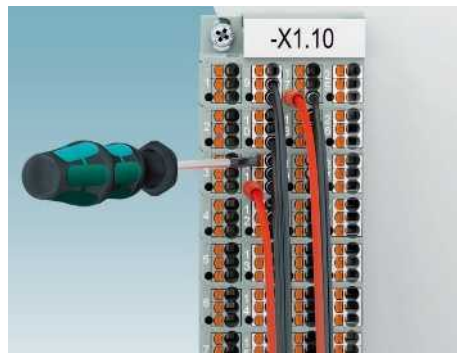

Operation with a practical focus









Freely accessible 2.3 mm test points centered next to the connection points enable convenient testing.











Flexible marking

Large label carriers that can be inserted individually enable matrix identification and provide the best possible overview when wiring and testing.





PTMC marshaling patchboards

Marshaling patchboards, for self-assembly								
		gray/gray gray/white gray/blue gray/red gray/green gray/brown gray/black gray/violet gray/orange gray/yellow gray/pink	PTMC 1,5-2 /GY PTMC 1,5-2 /WH PTMC 1,5-2 /BU PTMC 1,5-2 /RD PTMC 1,5-2 /GN PTMC 1,5-2 /BN PTMC 1,5-2 /BK PTMC 1,5-2 /VT PTMC 1,5-2 /OG PTMC 1,5-2 /YE PTMC 1,5-2 /PK	3270302 3270303 3270430 3270431 3270432 3270433 3270434 3270435 3270436 3270437 3270438	PTMC 1,5-3 /GY PTMC 1,5-3 /WH PTMC 1,5-3 /BU PTMC 1,5-3 /RD PTMC 1,5-3 /GN PTMC 1,5-3 /BN PTMC 1,5-3 /BK PTMC 1,5-3 /VT PTMC 1,5-3 /OG PTMC 1,5-3 /YE PTMC 1,5-3 /PK	3270300 3270301 3270420 3270421 3270422 3270423 3270424 3270425 3270426 3270427 3270428		
Width / Length / Height	[mm]	11 / 8.6 / 30		11 / 12.2 / 30				
Current / voltage // UL	[A] / [V]	17.5 // 500 / 10 / 300		17.5 // 500 / 10 / 300				
rigid / AWG // flexible / AWG	[mm²] / [-]	0.14 - 2.5 / 26 - 14 // 0.14 - 1.5 / 26 - 14		0.14 - 2.5 / 26 - 14 // 0.14 - 1.5 / 26 - 14				
Stranded with ferrule without / with plastic sleeve	[mm²]	0.14 - 1.5 / 0.14 - 1.5		0.14 - 1.5 / 0.14 - 1.5				
Directly pluggable: with ferrule / rigid	[mm²]	0.34 - 1.5 / 0.34 - 2.5		0.34 - 1.5 / 0.34 - 2.5				
Cover flange for direct mounting and marker adapter								
		gray	DF-PTMC-O	3270400	DF-PTMC-U	3270401	DF-PTMC-ZB	3270410
Width / Length / Height	[mm]	22 / 30 / 13		22 / 29.1 / 12.8		11 / 30 / 13		
rigid / AWG // flexible / AWG	[-]	- // -		- // -		- // -		
Adapter for DIN rail mounting and marker adapter								
		gray	DF-PTMC-NS	3270403				
Width / Length / Height	[mm]	22 / 64 / 21.5						
rigid / AWG // flexible / AWG	[-]	- // -						
Marshaling patchboards, pre-assembled with four connections per element								
		gray/gray/white gray/blue	PTMC 1,5/18	3270390	PTMC 1,5/32-2 PTMC 1,5/32-2 /BU	3270314 3270315	PTMC 1,5/48-2 PTMC 1,5/48-2 /BU	3270322 3270323
Width / Length / Height	[mm]	22 / 131 / 30		44 / 73.2 / 30		66 / 73.2 / 30		
Current / voltage // UL	[A] / [V]	17.5 // 500 / 10 / 300		17.5 // 500 / 10 / 300		17.5 // 500 / 10 / 300		
rigid / AWG // flexible / AWG	[mm²] / [-]	0.14 - 2.5 / 26 - 14 // 0.14 - 1.5 / 26 - 14		0.14 - 2.5 / 26 - 14 // 0.14 - 1.5 / 26 - 14		0.14 - 2.5 / 26 - 14 // 0.14 - 1.5 / 26 - 14		
Stranded with ferrule without / with plastic sleeve	[mm²]	0.14 - 1.5 / 0.14 - 1.5		0.14 - 1.5 / 0.14 - 1.5		0.14 - 1.5 / 0.14 - 1.5		
Directly pluggable: with ferrule / rigid	[mm²]	- / 0.34 - 2.5		0.34 - 1.5 / 0.34 - 2.5		0.34 - 1.5 / 0.34 - 2.5		

PTMC marshaling patchboards

				
	gray/gray/white gray/blue	PTMC 1,5/54 3270391	PTMC 1,5/80-2 PTMC 1,5/80-2 /BU 3270329 3270330	
Width / Length / Height	[mm]	33 / 157.4 / 30	110 / 73.2 / 30	
Current / voltage // UL	[A] / [V]	17.5 // 500 / 10 / 300	17.5 // 500 / 10 / 300	
rigid / AWG // flexible / AWG	[mm ²] / [-]	0.14 - 2.5 / 26 - 14 // 0.14 - 1.5 / 26 - 14	0.14 - 2.5 / 26 - 14 // 0.14 - 1.5 / 26 - 14	
Stranded with ferrule without / with plastic sleeve	[mm ²]	0.14 - 1.5 / 0.14 - 1.5	0.14 - 1.5 / 0.14 - 1.5	
Directly pluggable: with ferrule / rigid	[mm ²]	- / 0.34 - 2.5	0.34 - 1.5 / 0.34 - 2.5	
Marshaling patchboards, pre-assembled with six connections per element				
				
	gray/gray/white gray/blue	PTMC 1,5/32-3 PTMC 1,5/32-3 /BU 3270310 3270312	PTMC 1,5/48-3 PTMC 1,5/48-3 /BU 3270318 3270320	PTMC 1,5/80-3 PTMC 1,5/80-3 /BU 3270324 3270326
Width / Length / Height	[mm]	44 / 102 / 30	66 / 102 / 30	110 / 102 / 30
Current / voltage // UL	[A] / [V]	17.5 // 500 / 10 / 300	17.5 // 500 / 10 / 300	17.5 // 500 / 10 / 300
rigid / AWG // flexible / AWG	[mm ²] / [-]	0.14 - 2.5 / 26 - 14 // 0.14 - 1.5 / 26 - 14	0.14 - 2.5 / 26 - 14 // 0.14 - 1.5 / 26 - 14	0.14 - 2.5 / 26 - 14 // 0.14 - 1.5 / 26 - 14
Stranded with ferrule without / with plastic sleeve	[mm ²]	0.14 - 1.5 / 0.14 - 1.5	0.14 - 1.5 / 0.14 - 1.5	0.14 - 1.5 / 0.14 - 1.5
Directly pluggable: with ferrule / rigid	[mm ²]	0.34 - 1.5 / 0.34 - 2.5	0.34 - 1.5 / 0.34 - 2.5	0.34 - 1.5 / 0.34 - 2.5
Marshaling patchboards, pre-assembled for 19" rack, four connections per element				
				
	gray/gray/white gray/blue	PTMC 1,5/32-2H 19Z PTMC 1,5/32-2H /BU 19Z 3270316 3270317		
Width / Length / Height	[mm]	34.4 / 111 / 30		
Current / voltage // UL	[A] / [V]	17.5 // 500 / 10 / 300		
rigid / AWG // flexible / AWG	[mm ²] / [-]	0.14 - 2.5 / 26 - 14 // 0.14 - 1.5 / 26 - 14		
Stranded with ferrule without / with plastic sleeve	[mm ²]	0.14 - 1.5 / 0.14 - 1.5		
Directly pluggable: with ferrule / rigid	[mm ²]	0.34 - 1.5 / 0.34 - 2.5		
Marshaling patchboards, pre-assembled for 19" rack, six connections per element				
				
	gray/gray/white gray/blue	PTMC 1,5/32-3 19Z PTMC 1,5/32-3 /BU 19Z 3270311 3270313	PTMC 1,5/48-3 19Z PTMC 1,5/48-3 /BU 19Z 3270319 3270321	PTMC 1,5/80-3 19Z PTMC 1,5/80-3 /BU 19Z 3270325 3270327
Width / Length / Height	[mm]	44 / 111 / 30	66 / 111 / 30	110 / 111 / 30
Current / voltage // UL	[A] / [V]	17.5 // 500 / 10 / 300	17.5 // 500 / 10 / 300	17.5 // 500 / 10 / 300
rigid / AWG // flexible / AWG	[mm ²] / [-]	0.14 - 2.5 / 26 - 14 // 0.14 - 1.5 / 26 - 14	0.14 - 2.5 / 26 - 14 // 0.14 - 1.5 / 26 - 14	0.14 - 2.5 / 26 - 14 // 0.14 - 1.5 / 26 - 14
Stranded with ferrule without / with plastic sleeve	[mm ²]	0.14 - 1.5 / 0.14 - 1.5	0.14 - 1.5 / 0.14 - 1.5	0.14 - 1.5 / 0.14 - 1.5
Directly pluggable: with ferrule / rigid	[mm ²]	0.34 - 1.5 / 0.34 - 2.5	0.34 - 1.5 / 0.34 - 2.5	0.34 - 1.5 / 0.34 - 2.5

PTMC marshaling patchboards

Marshaling patchboards for free assembly for direct mounting					
	gray	PTMC 1,5 /1-2 -DF	3001937	PTMC 1,5 /1-3 -DF	3001929
	gray	PTMC 1,5 /2-2 -DF	3001940	PTMC 1,5 /2-3 -DF	3001930
	gray	PTMC 1,5 /3-2 -DF	3001942	PTMC 1,5 /3-3 -DF	3001931
	gray	PTMC 1,5 /4-2 -DF	3001943	PTMC 1,5 /4-3 -DF	3001932
	gray	PTMC 1,5 /5-2 -DF	3001944	PTMC 1,5 /5-3 -DF	3001933
	gray	PTMC 1,5 /6-2 -DF	3001945	PTMC 1,5 /6-3 -DF	3001934
	gray	PTMC 1,5 /7-2 -DF	3001946	PTMC 1,5 /7-3 -DF	3001935
	gray	PTMC 1,5 /8-2 -DF	3001947	PTMC 1,5 /8-3 -DF	3001936
Width / Length / Height	[mm]	30 / 13		30 / 16.6	
Current / voltage // UL	[A] / [V]	10 // 500 / 10 / 300		10 // 500 / 10 / 300	
rigid / AWG // flexible / AWG	[mm ²] / [-]	0.14 - 2.5 / 26 - 14 // 0.14 - 1.5 / 26 - 14		0.14 - 2.5 / 26 - 14 // 0.14 - 1.5 / 26 - 14	
Stranded with ferrule without / with plastic sleeve	[mm ²]	0.14 - 1.5 / 0.14 - 1.5		0.14 - 1.5 / 0.14 - 1.5	
Directly pluggable: with ferrule / rigid	[mm ²]	0.34 - 1.5 / 0.34 - 2.5		0.34 - 1.5 / 0.34 - 2.5	
Marshaling patchboards for free assembly for DIN rail mounting					
	gray	PTMC 1,5 /1-2 -NS	3001915	PTMC 1,5 /1-3 -NS	3001905
	gray	PTMC 1,5 /2-2 -NS	3001916	PTMC 1,5 /2-3 -NS	3001906
	gray	PTMC 1,5 /3-2 -NS	3001917	PTMC 1,5 /3-3 -NS	3001907
	gray	PTMC 1,5 /4-2 -NS	3001918	PTMC 1,5 /4-3 -NS	3001908
	gray	PTMC 1,5 /5-2 -NS	3001919	PTMC 1,5 /5-3 -NS	3001910
	gray	PTMC 1,5 /6-2 -NS	3001920	PTMC 1,5 /6-3 -NS	3001911
	gray	PTMC 1,5 /7-2 -NS	3001921	PTMC 1,5 /7-3 -NS	3001913
	gray	PTMC 1,5 /8-2 -NS	3001922	PTMC 1,5 /8-3 -NS	3001914
Width / Length / Height	[mm]	63 / 22.6		63 / 26.2	
Current / voltage // UL	[A] / [V]	10 // 500 / 10 / 300		10 // 500 / 10 / 300	
rigid / AWG // flexible / AWG	[mm ²] / [-]	0.14 - 2.5 / 26 - 14 // 0.14 - 1.5 / 26 - 14		0.14 - 2.5 / 26 - 14 // 0.14 - 1.5 / 26 - 14	
Stranded with ferrule without / with plastic sleeve	[mm ²]	0.14 - 1.5 / 0.14 - 1.5		0.14 - 1.5 / 0.14 - 1.5	
Directly pluggable: with ferrule / rigid	[mm ²]	0.34 - 1.5 / 0.34 - 2.5		0.34 - 1.5 / 0.34 - 2.5	

Flexible for all transformer circuits – PTME test disconnect terminal blocks

The new test disconnect terminal blocks can be used to design space-saving modular switching devices. In addition to the disconnect terminal blocks, feed-through and PE terminal blocks of the same shape are available. The patented short-circuit plug is particularly user-friendly and safe: measuring transducers are protected against damage by means of automatic short circuit.

i Web code: #1095



Unlimited flexibility

The triple function shaft on both sides of the section disconnect point enables the individual placement of bridging, testing, and switching accessories.

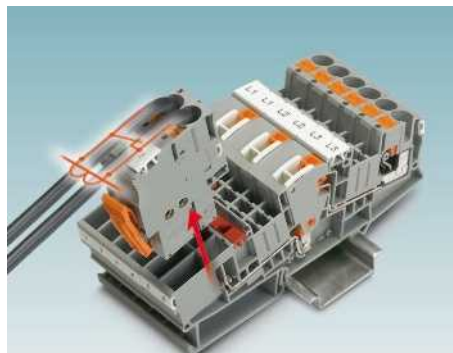

Automatic short circuiting

The pluggable test disconnect terminal blocks also enable the safe wiring of transformers. Unplugging the plug generates an automatic leading transformer short circuit.

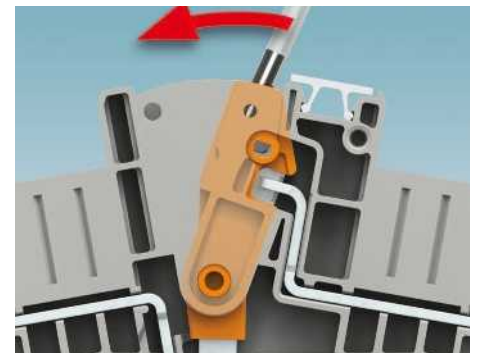

Easy and safe isolation

The section disconnecter reliably makes contact and latches with a swiveling movement into the respective switching state.

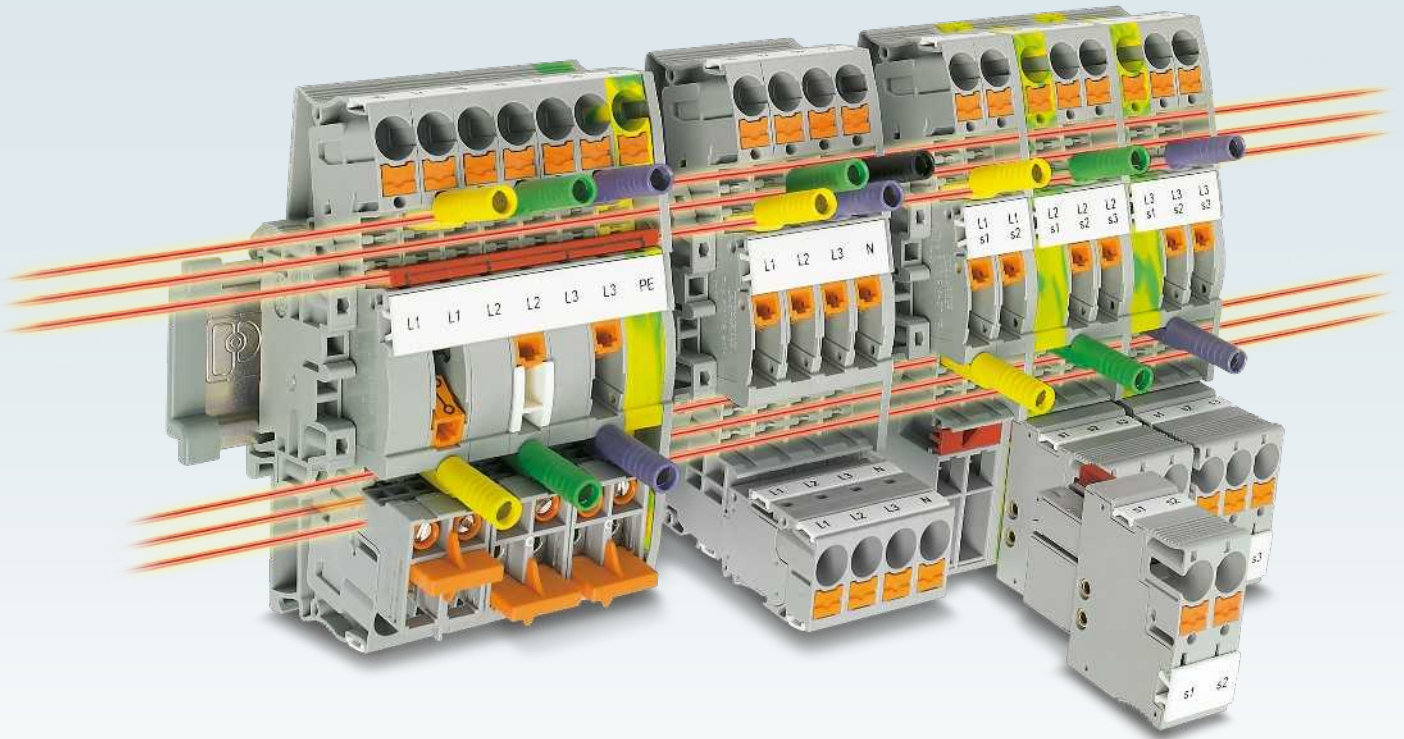

Safe short circuiting with bridge bars

The plug-in current transformer short-circuit bridges can be used individually, depending on the switching task, in the terminal block function shafts.

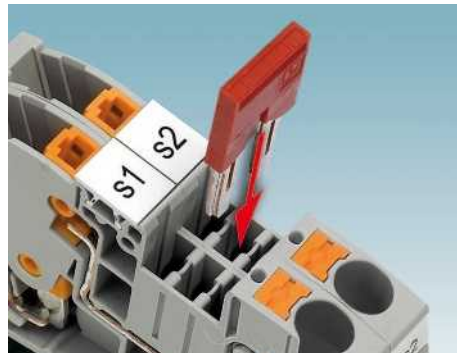

Safe short circuiting with plug-in bridges



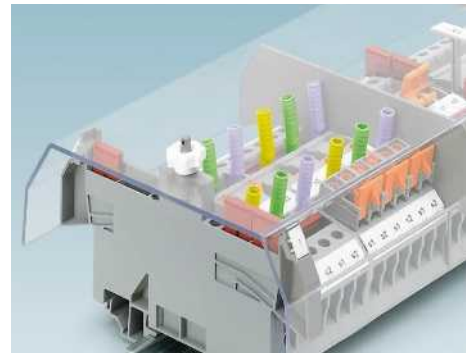





The current transformer short circuit can be realized easily with the standard FBS plug-in bridges. FBSRH versions with molded extraction tool are available with 2-, 3-, and 4-positions.



Safe covering

Cover profiles and covering hoods are available as accessories. The profiles can be mounted on measuring transducer strips and sealed as protection against external influences and manipulation.

PTME test disconnect terminal blocks

Push-in connection technology, 4 mm ²				
	gray green-yellow	PTME 4 3212139	PTMED 4 3212141	PTMED 4-PE 3212154
Width / Length / Height	[mm]	6.2 / 70.5 / 49.5	6.2 / 70.5 / 49.5	6.2 / 70.5 / 49.5
Current / voltage // UL	[A] / [V]	24 // 500 / 26 / 300	32 // 500 / 26 / 300	- // - // -
rigid / AWG // flexible / AWG	[mm ²] / [-]	0.2 - 6 / 24 - 10 // 0.2 - 4 / 24 - 12	0.2 - 6 / 24 - 10 // 0.2 - 4 / 24 - 12	0.2 - 6 / 24 - 10 // 0.2 - 4 / 24 - 12
Stranded with ferrule without / with plastic sleeve	[mm ²]	0.25 - 4 / 0.25 - 4	0.25 - 4 / 0.25 - 4	0.25 - 4 / 0.25 - 4
Directly pluggable: with ferrule / rigid	[mm ²]	0.5 - 4 / 0.5 - 6	0.5 - 4 / 0.5 - 6	0.5 - 4 / 0.5 - 6
Push-in connection technology, 6 mm ²				
	gray green-yellow	PTME 6 3212170	PTMED 6 3212183	PTMED 6-PE 3212196
Width / Length / Height	[mm]	8.2 / 100.8 / 49.6	8.2 / 100.8 / 49.6	8.2 / 100.8 / 49.6
Current / voltage // UL	[A] / [V]	30 // 500 / 30 / 600	41 // 1,000 / 30 / 600	- // - // -
rigid / AWG // flexible / AWG	[mm ²] / [-]	0.5 - 10 / 20 - 8 // 0.5 - 6 / 20 - 10	0.5 - 10 / 20 - 8 // 0.5 - 6 / 20 - 10	0.5 - 10 / 20 - 8 // 0.5 - 6 / 20 - 10
Stranded with ferrule without / with plastic sleeve	[mm ²]	0.5 - 6 / 0.5 - 6	0.5 - 6 / 0.5 - 6	0.5 - 6 / 0.5 - 6
Directly pluggable: with ferrule / rigid	[mm ²]	1 - 6 / 1 - 10	1 - 6 / 1 - 10	1 - 6 / 1 - 10
Hybrid terminal blocks 6 mm ² , with screw connection on one side				
Rated data for second connection technology at www.phoenixcontact.net/products				
	gray gray	PTU 6-T PTU 6-T-P 3209535 3209530	PTUD 6 PTUD 6-P 3209531 3209537	
Width / Length / Height	[mm]	8.2 / 73.9 / 48	8.2 / 73.9 / 48	
Current / voltage // UL	[A] / [V]	41 // 500	41 // 800	
rigid / AWG // flexible / AWG	[mm ²] / [-]	0.5 - 10 / 20 - 8 // 0.5 - 6 / 20 - 10	0.5 - 10 / 20 - 8 // 0.5 - 6 / 20 - 10	
Stranded with ferrule without / with plastic sleeve	[mm ²]	0.5 - 6 / 0.5 - 6	0.5 - 6 / 0.5 - 6	
Directly pluggable: with ferrule / rigid	[mm ²]	1 - 6 / 1 - 10	1 - 6 / 1 - 10	
PT-COMBI 6 mm ² Push-in connection terminal blocks				
	gray	PTME 6/1P 3212306		
Width / Length / Height	[mm]	8.2 / 99.4 / 49.6		
Current / voltage // UL	[A] / [V]	30 // 500 / 30 / 600		
rigid / AWG // flexible / AWG	[mm ²] / [-]	0.5 - 10 / 20 - 8 // 0.5 - 6 / 20 - 10		
Stranded with ferrule without / with plastic sleeve	[mm ²]	0.5 - 6 / 0.5 - 6		
Directly pluggable: with ferrule / rigid	[mm ²]	1 - 6 / 1 - 10		

PTME test disconnect terminal blocks

PT-COMBI 6 mm ² Push-in connection terminal blocks with automatic short circuit function				
	gray green-yellow	PTME 6-CT/1P 3212300	PTMED 6-CT/1P PTMED 6-CT/1P-PE 3212301 3212302	
Width / Length / Height	[mm]	8.2 / 114.9 / 49.6	8.2 / 114.9 / 49.6	
Current / voltage // UL	[A] / [V]	30 // 500 / 30 / 600	30 // 500 / 30 / 600	
rigid / AWG // flexible / AWG	[mm ²] / [-]	0.5 - 10 / 20 - 8 // 0.5 - 6 / 20 - 10	0.5 - 10 / 20 - 8 // 0.5 - 6 / 20 - 10	
Stranded with ferrule without / with plastic sleeve	[mm ²]	0.5 - 6 / 0.5 - 6	0.5 - 6 / 0.5 - 6	
Directly pluggable: with ferrule / rigid	[mm ²]	1 - 6 / 1 - 10	1 - 6 / 1 - 10	

Easy and safe testing – FAME plug-in test system

FAME 2 is the innovative test system for all measuring and testing tasks in network protection technology for medium and high-voltage switchgear. With the modular system, you can now perform manual testing operations automatically, safely, and more quickly. The plug-in test system combines the switching operations of the current transformer, voltage transformer, and signal contact functions in a single block.

 **Web code:** #0131

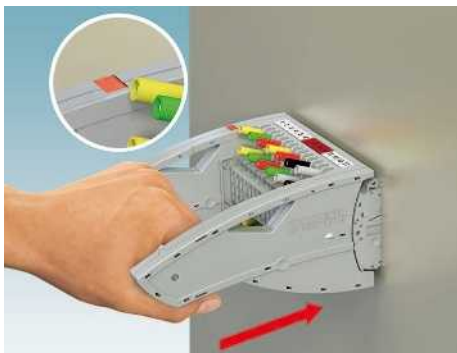

Plugging in the plug

The test plug is inserted fully and latches securely. The display window turns red. All test contacts are contacted in accordance with the test setup.

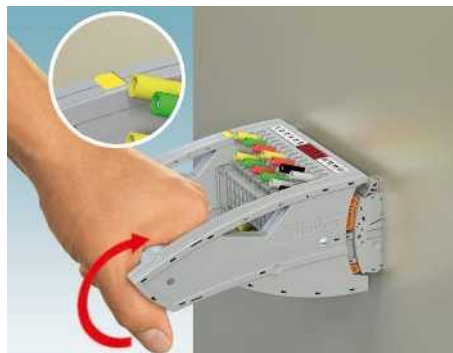

Partial unlocking of the plug

The rotary handle is turned upward as far as it will go. The display window turns yellow. The test contacts are once again through-connected to the protective device.

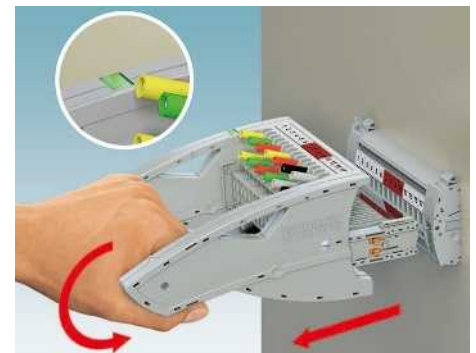

Unlocking the plug

The rotary handle must be turned back to its starting position. The display window turns green. Now the mechanism releases the plug so it can be fully removed.

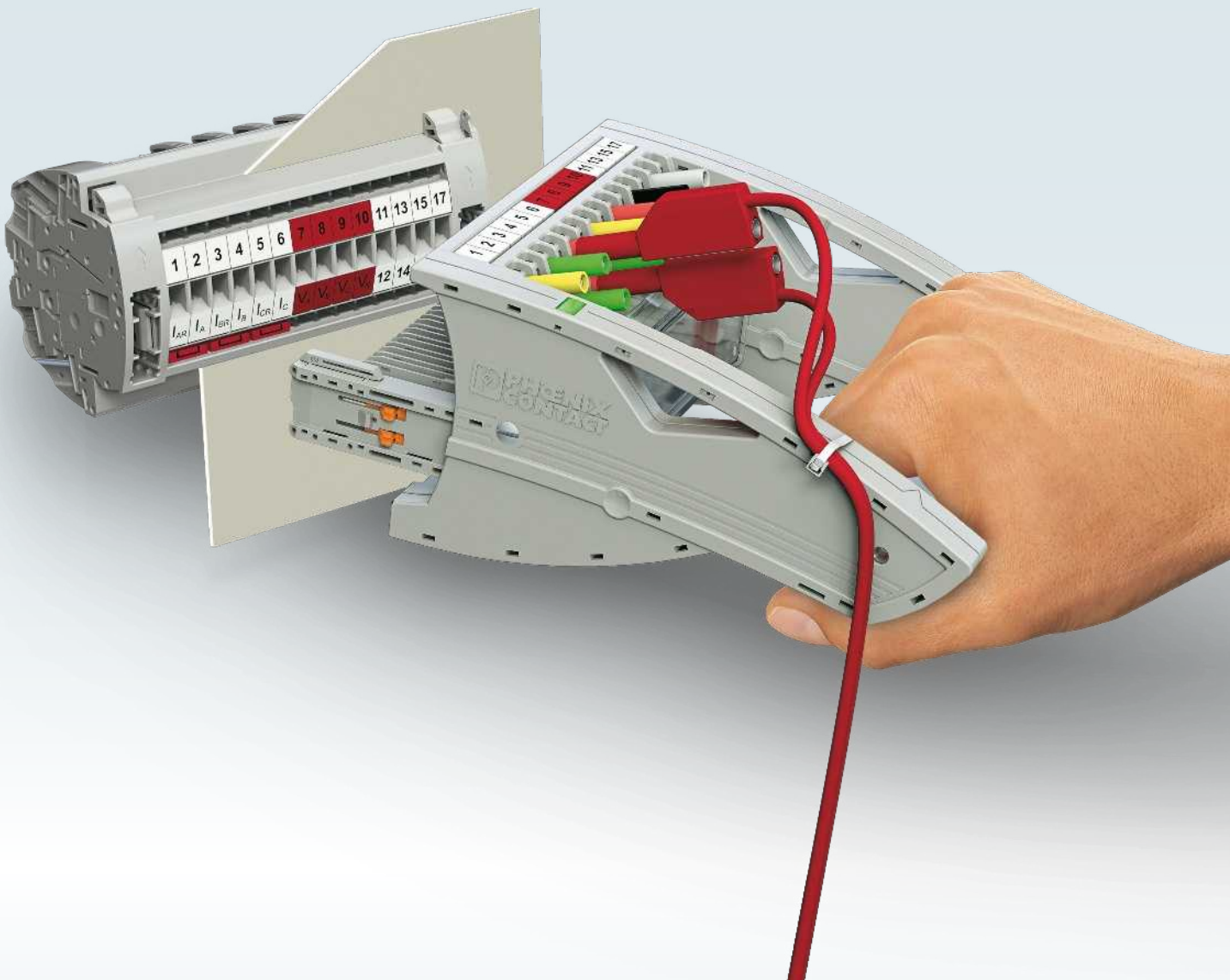

Safe with forced switching sequence

Via three different contact tab lengths, the test plug enables the switching sequence of the individual functions to be carried out with safe chronological disconnection with one switching operation .

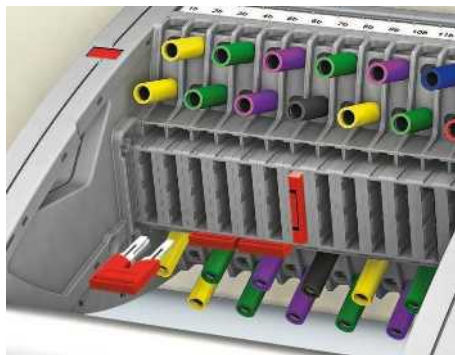

Safe transformer short circuit

The short-circuit bridging can be made to be clearly visible with standard plug-in bridges in the test plug. An optional cover profile protects against manipulation.

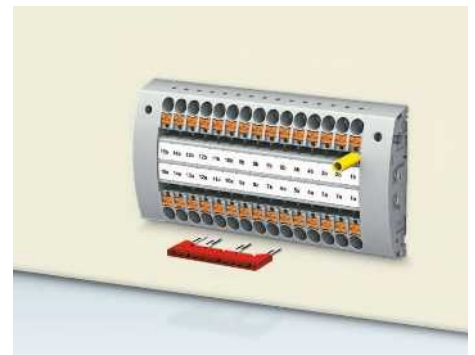

Simple star-point bridging

The plug-in test sockets for wall mounting cabinet feature six function shafts inside the control cabinet for forming and grounding the star point.

Clear and safe – PTI installation terminal blocks

The building installation terminal blocks are precisely tailored to the requirements of the electrical installations and distributor construction. The neutral conductor can be conveniently separated for your test tasks by means of a screwless, spring-loaded disconnect metal. Contact with the neutral busbar is established by simply swinging it open using a standard screwdriver.

i Web code: #0073

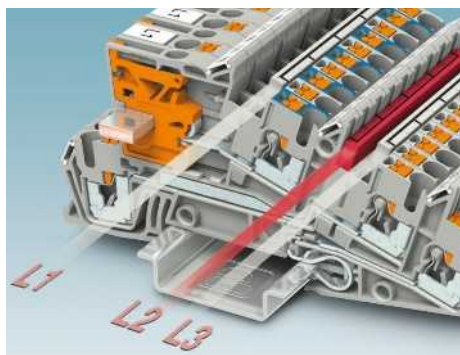

Double function shaft

Two function shafts are available per level to enable fast potential distribution. Use the standard bridges of the CLIPLINE complete system to do this.



Fast and safe neutral conductor disconnection

All neutral conductor disconnect terminal blocks have a robust disconnect slide. Swiveling with a standard screwdriver slides the contact fork onto the busbar.

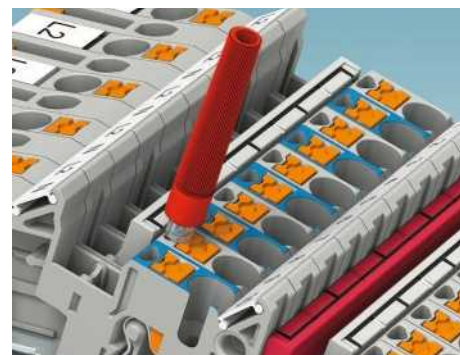

Testing option at every terminal point

All test plugs and test adapters make contact in the function shaft. And each terminal point has an additional 2.3 mm test contact.

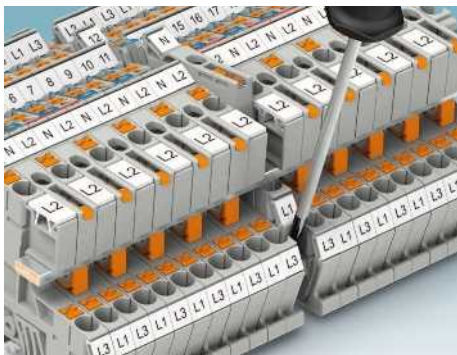
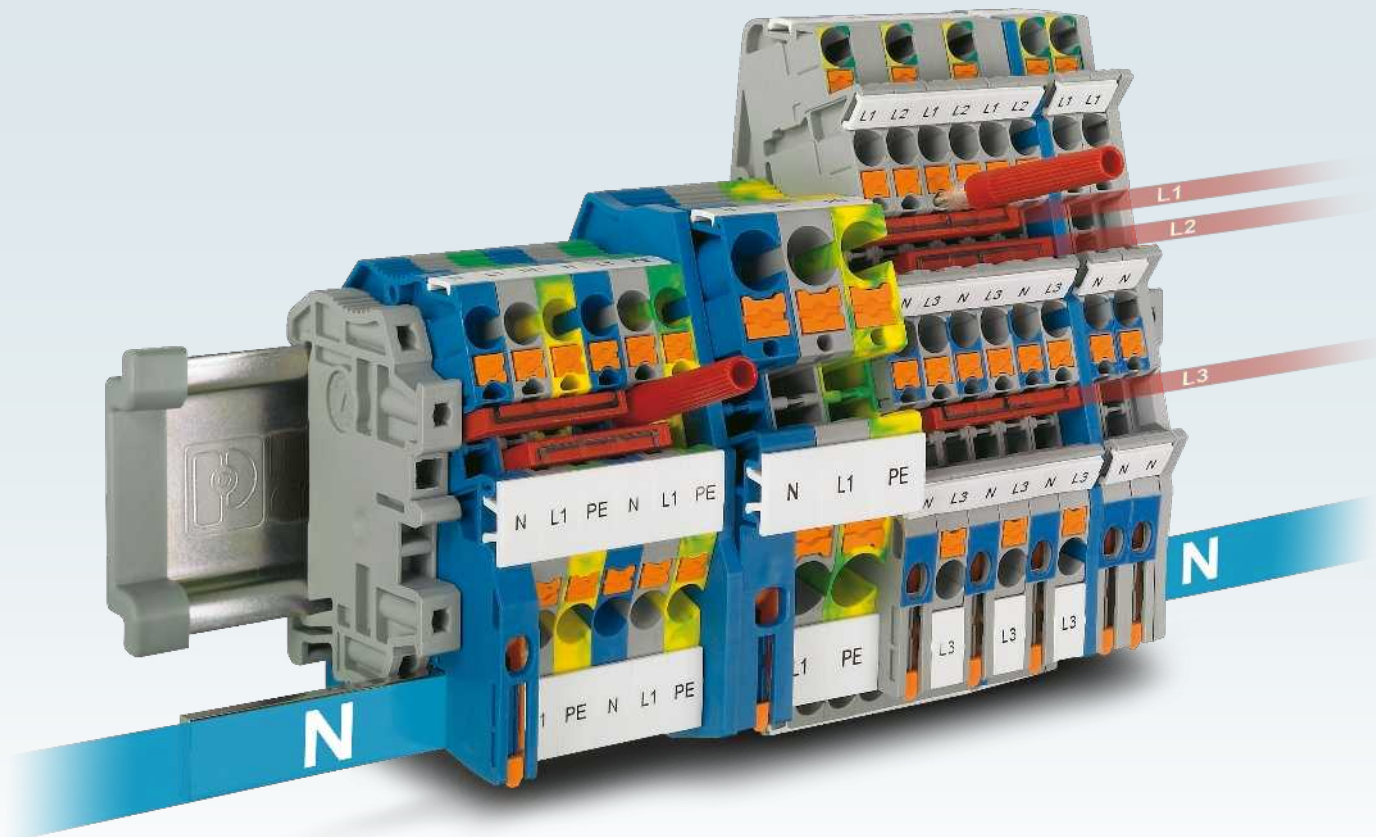

Easy installation

The installation terminal blocks can be easily retrofitted into existing installations or replaced, without having to remove the neutral busbar.

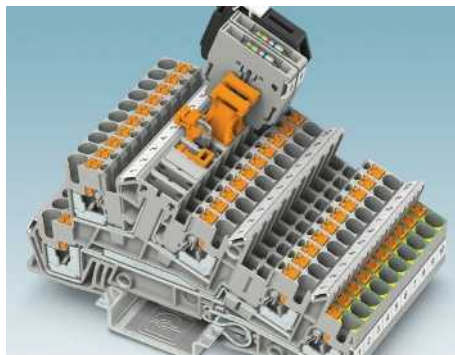

Individual circuit disconnection







The installation terminal blocks with disconnect knife for individual circuit disconnection are tailored to your specific installation technology requirements.











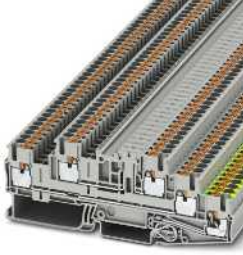

Installation terminal block system

PTI installation terminal blocks facilitate the quick and space-saving configuration of building installation distribution boards.

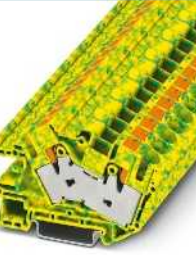



PTI installation terminal blocks

Two-conductor terminals					
	gray blue	PTI 2,5 PTI 2,5 BU	3213968 3213969	PTI 4 PTI 4 BU	3213970 3213971
Width / Length / Height	[mm]	5.2 / 59.5 / 44		6.2 / 66 / 44	8.2 / 66 / 50
Current / voltage // UL	[A] / [V]	24 // 800 / 20 / 600		32 // 800 / - / -	41 // 800 / - / -
rigid / AWG // flexible / AWG	[mm ²] / [-]	0.14 - 4 / 26 - 12 // 0.14 - 4 / 26 - 12		0.2 - 6 / 24 - 10 // 0.2 - 6 / 24 - 10	0.5 - 10 / 20 - 8 // 0.5 - 6 / 20 - 10
Stranded with ferrule without / with plastic sleeve	[mm ²]	0.14 - 2.5 / 0.14 - 2.5		0.25 - 4 / 0.25 - 4	0.5 - 6 / 0.5 - 6
Directly pluggable: with ferrule / rigid	[mm ²]	0.34 - 2.5 / 0.34 - 4		0.5 - 4 / 0.5 - 6	1 - 6 / 1 - 10
	gray blue	PTI 16/S PTI 16/S BU	3214029 3214023		
Width / Length / Height	[mm]	10.2 / 77.7 / 51.1			
Current / voltage // UL	[A] / [V]	76 // 500 / 10 / 600			
rigid / AWG // flexible / AWG	[mm ²] / [-]	0.5 - 16 / 24 - 4 // 0.5 - 16 / 24 - 4			
Stranded with ferrule without / with plastic sleeve	[mm ²]	0.5 - 16 / 0.5 - 16			
Directly pluggable: with ferrule / rigid	[mm ²]	4 - 16 / 1 - 16			
Three-level terminal blocks					
... PE/L/N = upper level blue, middle level gray, lower level green-yellow with PE foot ... PE/L/L = upper and middle level gray, lower level green-yellow with PE foot					
	gray/blue gray gray	PTI 2,5-N PTI 2,5-L	3213952 3213951	PTI 2,5-L/N PTI 2,5-L/L	3213954 3213953
Width / Length / Height	[mm]	5.2 / 101 / 50.5		5.2 / 101 / 50.5	5.2 / 101 / 50.5
Current / voltage // UL	[A] / [V]	24 // 400 / 20 / 300		24 // 400 / 20 / 300	24 // 400 / - / -
rigid / AWG // flexible / AWG	[mm ²] / [-]	0.14 - 4 / 26 - 12 // 0.14 - 4 / 26 - 12		0.14 - 4 / 26 - 12 // 0.14 - 4 / 26 - 12	0.14 - 4 / 26 - 12 // 0.14 - 4 / 26 - 12
Stranded with ferrule without / with plastic sleeve	[mm ²]	0.14 - 2.5 / 0.14 - 2.5		0.14 - 2.5 / 0.14 - 2.5	0.14 - 2.5 / 0.14 - 2.5
Directly pluggable: with ferrule / rigid	[mm ²]	0.34 - 2.5 / 0.34 - 4		0.34 - 2.5 / 0.34 - 4	0.34 - 2.5 / 0.34 - 4
... L/N = upper level blue, lower level gray ... PE/L/N = upper level blue, middle level gray, lower level green-yellow with PE foot ... PE/L/L = upper and middle level gray, lower level green-yellow with PE foot					
	gray gray gray gray	PTI 4-L/N PTI 4-L/L PTI 4-PE/L/N PTI 4-PE/L/L	3214051 3214052 3214049 3214050		
Width / Length / Height	[mm]	6.2 / 114 / 50.5			
Current / voltage // UL	[A] / [V]	28 // 400 / 27 / 300			
rigid / AWG // flexible / AWG	[mm ²] / [-]	0.2 - 6 / 24 - 10 // 0.2 - 6 / 24 - 10			
Stranded with ferrule without / with plastic sleeve	[mm ²]	0.25 - 4 / 0.25 - 4			
Directly pluggable: with ferrule / rigid	[mm ²]	0.5 - 4 / 0.5 - 6			

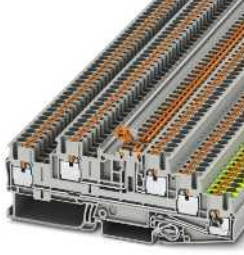

PTI installation terminal blocks

Ground terminal blocks				
... PE/L/N = upper level blue, middle level gray, lower level green-yellow with PE foot ... PE/L/L = upper and middle level gray, lower level green-yellow with PE foot				
	green-yellow gray gray	PTI 2,5-PE 3213962	PTI 2,5-PE/L/N PTI 2,5-PE/L/L 3213950 3213949	PTB 2,5-PE/L/L 3210547
Width / Length / Height	[mm]	5.2 / 59.5 / 44	5.2 / 101 / 50.5	5.2 / 118 / 42.3
Current / voltage // UL	[A] / [V]	24 // 800 / - / -	24 // 400 / 20 / 300	20 // 400 / - / -
rigid / AWG // flexible / AWG	[mm ²] / [-]	0.14 - 4 / 26 - 12 // 0.14 - 4 / 26 - 12	0.14 - 4 / 26 - 12 // 0.14 - 4 / 26 - 12	0.14 - 4 / 26 - 12 // 0.14 - 4 / 26 - 12
Stranded with ferrule without / with plastic sleeve	[mm ²]	0.14 - 2.5 / 0.14 - 2.5	0.14 - 2.5 / 0.14 - 2.5	0.14 - 2.5 / 0.14 - 2.5
Directly pluggable: with ferrule / rigid	[mm ²]	0.34 - 2.5 / 0.34 - 4	0.34 - 2.5 / 0.34 - 4	0.34 - 2.5 / 0.34 - 4
				
	green-yellow	PTI 4-PE 3213964	PTI 6-PE 3213966	PTI 16/S-PE 3214024
Width / Length / Height	[mm]	6.2 / 65.9 / 44	8.2 / 66 / 50	10.2 / 77.7 / 51.1
Current / voltage // UL	[A] / [V]	- / - / -	- / - / -	76 // 500 / 600
rigid / AWG // flexible / AWG	[mm ²] / [-]	0.2 - 6 / 24 - 10 // 0.2 - 6 / 24 - 10	0.5 - 10 / 20 - 8 // 0.5 - 6 / 20 - 10	0.5 - 16 / 24 - 4 // 0.5 - 16 / 24 - 4
Stranded with ferrule without / with plastic sleeve	[mm ²]	0.25 - 4 / 0.25 - 4	0.5 - 6 / 0.5 - 6	0.5 - 16 / 0.5 - 16
Directly pluggable: with ferrule / rigid	[mm ²]	0.5 - 4 / 0.5 - 6	1 - 6 / 1 - 10	4 - 16 / 1 - 16
Neutral conductor disconnect terminal blocks				
	blue	PTN 2,5 3213963	PTN 4 3213965	PTN 6 3213967
Width / Length / Height	[mm]	5.2 / 59 / 46.3	6.2 / 66 / 46.3	8.2 / 66.3 / 50
Current / voltage // UL	[A] / [V]	24 // 250 / 20 / 600	32 // 250 / - / -	41 // 400 / - / -
rigid / AWG // flexible / AWG	[mm ²] / [-]	0.14 - 4 / 26 - 12 // 0.14 - 4 / 26 - 12	0.2 - 6 / 24 - 10 // 0.2 - 4 / 24 - 12	0.5 - 10 / 20 - 8 // 0.5 - 6 / 20 - 10
Stranded with ferrule without / with plastic sleeve	[mm ²]	0.14 - 2.5 / 0.14 - 2.5	0.25 - 4 / 0.25 - 4	0.5 - 6 / 0.5 - 6
Directly pluggable: with ferrule / rigid	[mm ²]	0.34 - 2.5 / 0.34 - 4	0.5 - 4 / 0.5 - 6	1 - 6 / 1 - 10
				
	blue gray gray gray	PTN 16/S 3214025	PTI 2,5-L/NT PTI 2,5-L/LT PTI 2,5-PE/L/NT 3213947 3213948 3213946	PTI 4-PE/L/NT PTI 4-PE/L/LT 3214047 3214048
Width / Length / Height	[mm]	10.2 / 77.7 / 51.1	5.2 / 101 / 50.5	6.2 / 114 / 50.5
Current / voltage // UL	[A] / [V]	68 // 500 / 10 / 600	24 // 400 / 20 / 300	28 // 400 / 27 / 300
rigid / AWG // flexible / AWG	[mm ²] / [-]	0.5 - 16 / 24 - 4 // 0.5 - 16 / 24 - 4	0.14 - 4 / 26 - 12 // 0.14 - 4 / 26 - 12	0.2 - 6 / 24 - 10 // 0.2 - 6 / 24 - 10
Stranded with ferrule without / with plastic sleeve	[mm ²]	0.5 - 16 / 0.5 - 16	0.14 - 2.5 / 0.14 - 2.5	0.25 - 4 / 0.25 - 4
Directly pluggable: with ferrule / rigid	[mm ²]	4 - 16 / 1 - 16	0.34 - 2.5 / 0.34 - 4	0.5 - 4 / 0.5 - 6

PTI installation terminal blocks

Feed-in terminal blocks				
	blue gray red black/yellow	AB-PTI 16-NLS BU 1030138	PTI 16-NLS-FI BU PTI 16-NLS-FI PTI 16-NLS-FI RD PTI 16-NLS-FI-FE 1030131 1030130 1030132 1030135	
Width / Length / Height	[mm]	12.2 / 81.9 / 48.5	12.2 / 81.9 / 48.5	
Current / voltage // UL	[A] / [V]	- / - / - / -	70 // 1,000 / 70 / 1,000	
rigid / AWG // flexible / AWG	[mm ²] / [-]	- / - / - / -	0.5 - 25 / 20 - 4 // 0.5 - 16 / 24 - 4	
Stranded with ferrule without / with plastic sleeve	[mm ²]	- / -	0.5 - 16 / 0.5 - 16	
Directly pluggable: with ferrule / rigid	[mm ²]	- / -	2.5 - 16 / 2.5 - 25	
Disconnect and knife disconnect terminal blocks				
	gray gray	PTB 2,5-PE/L/MT 3210549	PTI 2,5-L/NTB PTI 2,5-PE/L/NTB 3213956 3213955	PTI 2,5-L/TG 3213961
Width / Length / Height	[mm]	5.2 / 118 / 42.3	5.2 / 101 / 50.5	5.2 / 101 / 50.5
Current / voltage // UL	[A] / [V]	22 // 400 / - / -	24 // 400 / - / -	24 // 400 / 20 / 300
rigid / AWG // flexible / AWG	[mm ²] / [-]	0.14 - 4 / 26 - 12 // 0.14 - 4 / 26 - 12	0.14 - 4 / 26 - 12 // 0.14 - 4 / 26 - 12	0.14 - 4 / 26 - 12 // 0.14 - 4 / 26 - 12
Stranded with ferrule without / with plastic sleeve	[mm ²]	0.14 - 2.5 / 0.14 - 2.5	0.14 - 2.5 / 0.14 - 2.5	0.14 - 2.5 / 0.14 - 2.5
Directly pluggable: with ferrule / rigid	[mm ²]	0.34 - 2.5 / 0.34 - 4	0.34 - 2.5 / 0.34 - 4	0.34 - 2.5 / 0.34 - 4
	gray gray	PTI 2,5-L/LTB 3213958	PTB 2,5-PE/L/NTG PTB 2,5-PE/L/TG 3210545 3210539	PTI 2,5-PE/L/TG 3213960
Width / Length / Height	[mm]	5.2 / 101 / 50.5	5.2 / 118 / 42.3	5.2 / 101 / 50.5
Current / voltage // UL	[A] / [V]	24 // 400 / 20 / 300	22 // 400 / - / -	24 // 400 / 20 / 300
rigid / AWG // flexible / AWG	[mm ²] / [-]	0.14 - 4 / 26 - 12 // 0.14 - 4 / 26 - 12	0.14 - 4 / 26 - 12 // 0.14 - 4 / 26 - 12	0.14 - 4 / 26 - 12 // 0.14 - 4 / 26 - 12
Stranded with ferrule without / with plastic sleeve	[mm ²]	0.14 - 2.5 / 0.14 - 2.5	0.14 - 2.5 / 0.14 - 2.5	0.14 - 2.5 / 0.14 - 2.5
Directly pluggable: with ferrule / rigid	[mm ²]	0.34 - 2.5 / 0.34 - 4	0.34 - 2.5 / 0.34 - 4	0.34 - 2.5 / 0.34 - 4
	gray	PTI 2,5-PE/L/LTB 3213957		
Width / Length / Height	[mm]	5.2 / 101 / 50.5		
Current / voltage // UL	[A] / [V]	24 // 400 / 20 / 300		
rigid / AWG // flexible / AWG	[mm ²] / [-]	0.14 - 4 / 26 - 12 // 0.14 - 4 / 26 - 12		
Stranded with ferrule without / with plastic sleeve	[mm ²]	0.14 - 2.5 / 0.14 - 2.5		
Directly pluggable: with ferrule / rigid	[mm ²]	0.34 - 2.5 / 0.34 - 4		

PTI installation terminal blocks

KNX terminal blocks		 	
	white	PTTBS 1,5/S-KNX	3214663
	white	PTTBS 1,5/S WH/U-YE/O-WH	3214661
	white	PTTBS 1,5/S WH/U-BK/O-RD	3214662
Width / Length / Height	[mm]	7 / 78.8 / 48.2	
Current / voltage // UL	[A] / [V]	16 // 500	
rigid / AWG // flexible / AWG	[mm ²] / [-]	0.14 - 1.5 / 26 - 14 // 0.14 - 1.5 / 26 - 14	
Stranded with ferrule without / with plastic sleeve	[mm ²]	0.14 - 1.5 / 0.14 - 1	
Directly pluggable: with ferrule / rigid	[mm ²]	0.34 - 1.5 / 0.25 - 1.5	

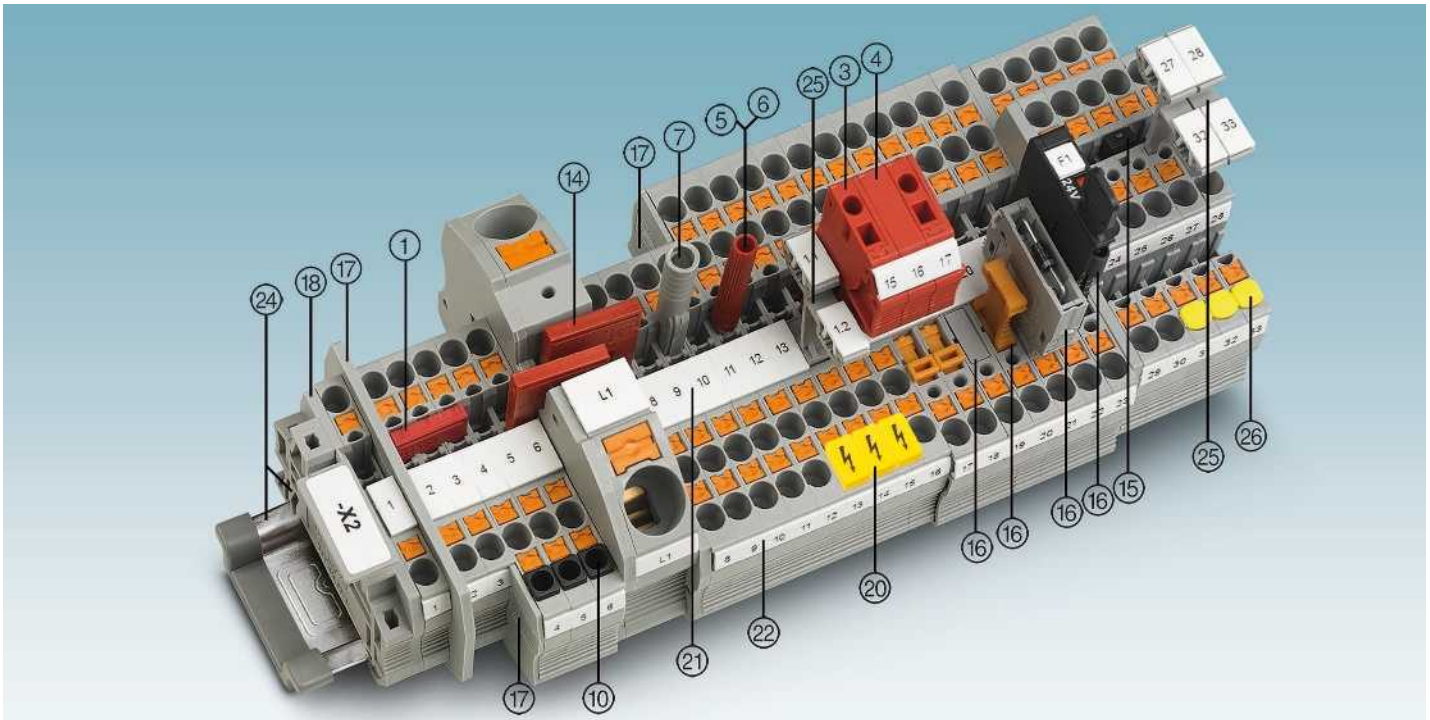

Figure reference	Web code:
① Plug-in bridges	#2284
③ Modular test plug	#2285
④ Spacer plates for PS...	#2286
⑤ Test plug metal part	#2287
⑥ Insulating sleeve for MPS metal part	#2288
⑦ Test adapter	#2289
⑩ Insulation stop sleeves	#2290
⑭ Reducing bridges	#2291
⑮ Vertical potential bridges	#2292
⑯ Fuse and function plugs for disconnect terminal blocks	#2293
⑰ Partition plates/end cover segments	#2294
⑱ Cover	#2294
⑳ Warning labels	#2299
㉑ Center groove labeling	#1087
㉒ Center and side groove labeling	#1087
㉔ DIN rails and end brackets	#2296
㉕ Marker carriers	#2297
㉖ Covers for the conductor shaft	#2298

The full range of accessories is available at phoenixcontact.net/products

Modular connection solutions – PT – pluggable terminal blocks

The COMBI connection system enables the time-saving and modular configuration of your application. The nominal data of up to 41 A and 1000 V is the basis for a unique connection system for signal and power wiring. The system also meets the most stringent vibration requirements. A comprehensive range of accessories is available, from latching mechanisms to shield connections.

i Web code: #1276



Powerful connection technology

The COMBI range features a free choice of connection technologies. The system enables wiring of up to 41 A nominal current, 1000 V nominal voltage and a nominal cross section of 6 mm².

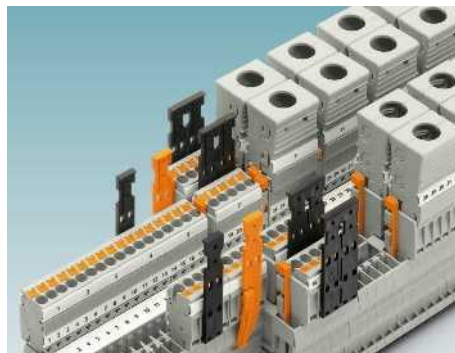

Latching and cable housings

Latching mechanisms are available for securing the connectors to the basic terminal blocks. Furthermore, strain relief mechanisms and closed cable housings are available to relieve the strain on cables.

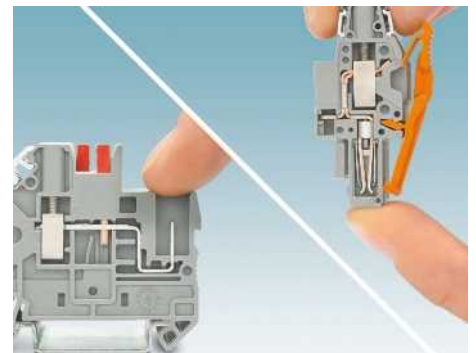

Protection against contact

The COMBI system features maximum user protection because both the basic terminal blocks and the connectors are designed to protect against contact.

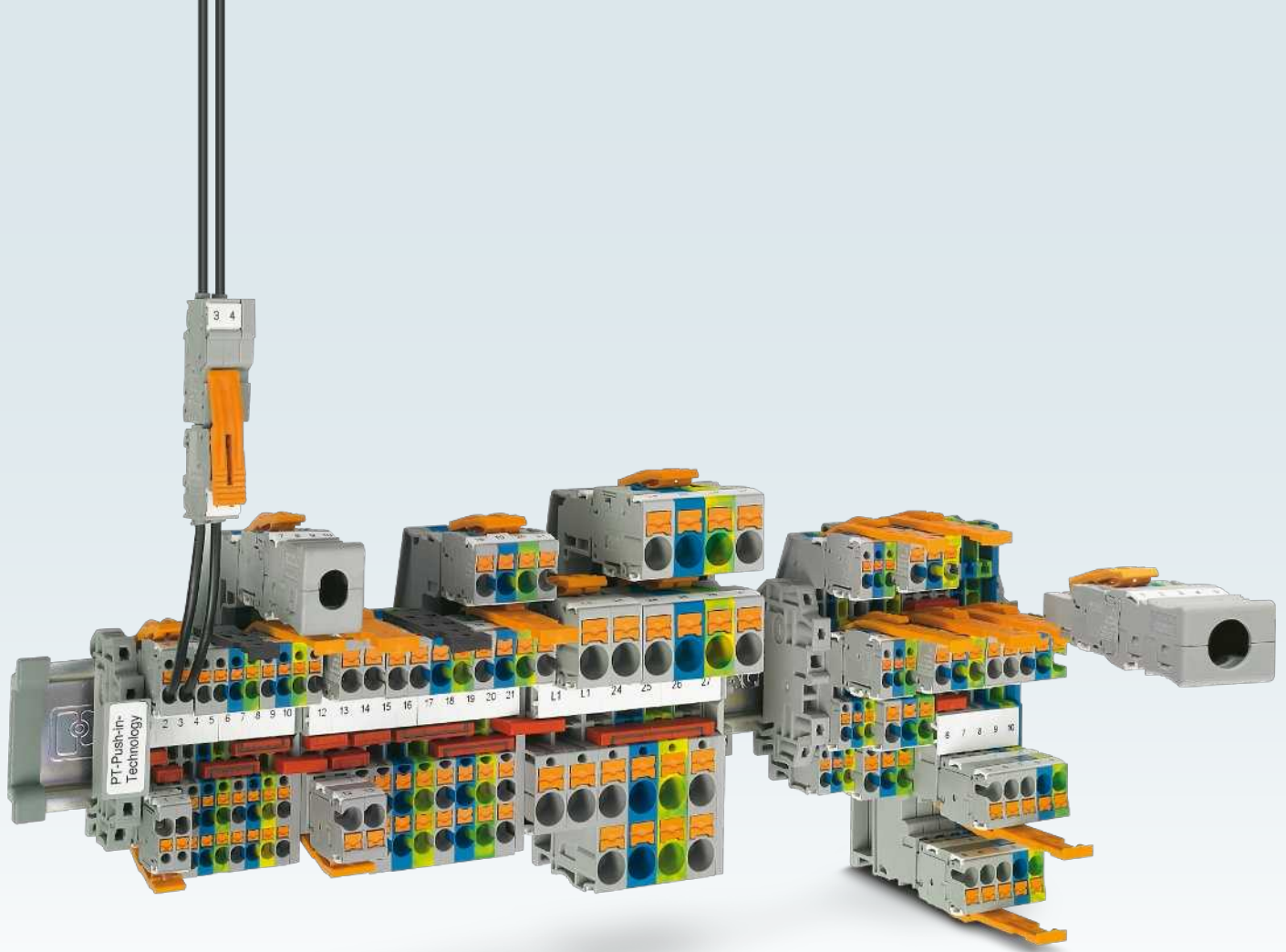

Crimp COMBI

The compact connector housings for crimp contacts suitable for automated processing can be plugged into all COMBI basic terminal blocks of the CLIPLINE complete terminal block system.



Coupling systems

The COMBI system features various floating couplings for the safe and space-saving accommodation of plug-in contacts in cable ducts and distribution shafts.













Panel feed-throughs

You can establish your panel feed-through efficiently in the prepared cut-out, thanks to the simple push-in mechanism and subsequent automatic latching.





PT plug-in terminal blocks

Plug-in COMBI terminal blocks				
	gray blue green-yellow	MPT 1,5/S/1P MPT 1,5/S/1P BU MPT 1,5/S/1P-PE	3248115 3248116 3248117	PT 1,5/S/1P PT 1,5/S/1P BU PT 1,5/S/1P-PE
		3208582 3208595 3212332	3210033 3210046 3210059	
Width / Length / Height	[mm]	3.5 / 33.55 / 28.1	3.5 / 46 / 32	5.2 / 48.5 / 36.5
Current / voltage // UL	[A] / [V]	17.5 // 500 / 15 / 600	17.5 // 500 / 15 / 600	24 // 500 / 20 / 600
rigid / AWG // flexible / AWG	[mm²] / [-]	0.14 - 1.5 / 26 - 14 // 0.14 - 1.5 / 26 - 14	0.14 - 1.5 / 26 - 14 // 0.14 - 1.5 / 26 - 14	0.14 - 4 / 26 - 12 // 0.14 - 2.5 / 26 - 14
Stranded with ferrule without / with plastic sleeve	[mm²]	0.14 - 1.5 / 0.14 - 1	0.14 - 1.5 / 0.14 - 1	0.14 - 2.5 / 0.14 - 2.5
Directly pluggable: with ferrule / rigid	[mm²]	0.34 - 1.5 / 0.25 - 1.5	0.34 - 1.5 / 0.25 - 1.5	0.34 - 2.5 / 0.34 - 4
				
	gray blue green-yellow	PT 4/1P PT 4/1P BU PT 4/1P-PE	3211937 3212007 3211942	PT 6/1P PT 6/1P BU PT 6/1P-PE
		3061758 3061761 3061774	3212358 3212361 3212374	
Width / Length / Height	[mm]	6.2 / 56 / 36.5	8.2 / 57.7 / 43.5	3.5 / 55 / 32
Current / voltage // UL	[A] / [V]	32 // 800 / 28 / 600	41 // 1,000 / 40 / 600	17.5 // 500 / 15 / 600
rigid / AWG // flexible / AWG	[mm²] / [-]	0.2 - 6 / 24 - 10 // 0.2 - 4 / 24 - 12	0.5 - 10 / 20 - 8 // 0.5 - 6 / 20 - 10	0.14 - 1.5 / 26 - 14 // 0.14 - 1.5 / 26 - 14
Stranded with ferrule without / with plastic sleeve	[mm²]	0.25 - 4 / 0.25 - 4	0.5 - 6 / 0.5 - 6	0.14 - 1.5 / 0.14 - 1
Directly pluggable: with ferrule / rigid	[mm²]	0.5 - 4 / 0.5 - 6	1 - 6 / 1 - 10	0.34 - 1.5 / 0.25 - 1.5
				
	gray blue green-yellow	PT 2,5-TWIN/1P PT 2,5-TWIN/1P BU PT 2,5-TWIN/1P-PE	3209633 3209646 3209659	PT 4-TWIN/1P PT 4-TWIN/1P BU PT 4-TWIN/1P-PE
		3212200 3212201 3212202	3212390 3212400 3212413	
Width / Length / Height	[mm]	5.2 / 60.5 / 36.5	6.2 / 66.4 / 36.5	3.5 / 78.5 / 32
Current / voltage // UL	[A] / [V]	24 // 500 / 20 / 600	32 // 800 / 28 / 600	17.5 // 500 / 15 / 600
rigid / AWG // flexible / AWG	[mm²] / [-]	0.14 - 4 / 26 - 12 // 0.14 - 2.5 / 26 - 14	0.2 - 6 / 24 - 10 // 0.2 - 4 / 24 - 12	0.14 - 1.5 / 26 - 14 // 0.14 - 1.5 / 26 - 14
Stranded with ferrule without / with plastic sleeve	[mm²]	0.14 - 2.5 / 0.14 - 2.5	0.25 - 4 / 0.25 - 4	0.14 - 1.5 / 0.14 - 1
Directly pluggable: with ferrule / rigid	[mm²]	0.34 - 2.5 / 0.34 - 4	0.5 - 4 / 0.5 - 6	0.34 - 1.5 / 0.25 - 1.5
				
	gray blue green-yellow	PT 2,5-QUATTRO/2P PT 2,5-QUATTRO/2P BU PT 2,5-QUATTRO/2P-PE	3209662 3209675 3209688	PT 4-QUATTRO/2P PT 4-QUATTRO/2P BU PT 4-QUATTRO/2P-PE
		3211991 3212000 3211999	3061826 3061839 3061842	
Width / Length / Height	[mm]	5.2 / 81 / 36.5	6.2 / 92.1 / 36.5	8.2 / 99.8 / 43.5
Current / voltage // UL	[A] / [V]	24 // 500 / 20 / 600	32 // 800 / 28 / 600	41 // 1,000 / 40 / 600
rigid / AWG // flexible / AWG	[mm²] / [-]	0.14 - 4 / 26 - 12 // 0.14 - 2.5 / 26 - 14	0.2 - 6 / 24 - 10 // 0.2 - 4 / 24 - 12	0.5 - 10 / 20 - 8 // 0.5 - 6 / 20 - 10
Stranded with ferrule without / with plastic sleeve	[mm²]	0.14 - 2.5 / 0.14 - 2.5	0.25 - 4 / 0.25 - 4	0.5 - 6 / 0.5 - 6
Directly pluggable: with ferrule / rigid	[mm²]	0.34 - 2.5 / 0.34 - 4	0.5 - 4 / 0.5 - 6	1 - 6 / 1 - 10







PT plug-in terminal blocks

			
	gray blue green-yellow green/yellow	PT 2,5-HEXA/3P PT 2,5-HEXA/3P BU PT 2,5-HEXA/3P-PE	PTTB 1,5/S/2P PTTB 1,5/S/2P BU PTTB 1,5/S/2P-PE
		3040044 3040048 3040052	3212439 3212442 3212455
Width / Length / Height	[mm]	5.2 / 111.2 / 36.8	3.5 / 69.3 / 42.6
Current / voltage // UL	[A] / [V]	24 // 500 / 20 / 300	16 // 500 / 15 / 600
rigid / AWG // flexible / AWG	[mm ²] / [-]	0.14 - 4 / 26 - 12 // 0.14 - 2.5 / 26 - 14	0.14 - 1.5 / 26 - 14 // 0.14 - 1.5 / 26 - 14
Stranded with ferrule without / with plastic sleeve	[mm ²]	0.14 - 2.5 / 0.14 - 2.5	0.14 - 1.5 / 0.14 - 1
Directly pluggable: with ferrule / rigid	[mm ²]	0.34 - 2.5 / 0.34 - 4	0.34 - 1.5 / 0.25 - 1.5
			
	gray blue green-yellow	PTTB 2,5/2P PTTB 2,5/2P BU PTTB 2,5/2P-PE	PTTB 2,5/2P-PV
		3210871 3210884 3210897	3210907
Width / Length / Height	[mm]	5.2 / 71.5 / 47.5	5.2 / 71.5 / 47.5
Current / voltage // UL	[A] / [V]	22 // 500 / 20 / 600	22 // 500 / 20 / 600
rigid / AWG // flexible / AWG	[mm ²] / [-]	0.14 - 4 / 26 - 12 // 0.14 - 2.5 / 26 - 14	0.14 - 4 / 26 - 12 // 0.14 - 2.5 / 26 - 14
Stranded with ferrule without / with plastic sleeve	[mm ²]	0.14 - 2.5 / 0.14 - 2.5	0.14 - 2.5 / 0.14 - 2.5
Directly pluggable: with ferrule / rigid	[mm ²]	0.34 - 2.5 / 0.34 - 4	0.34 - 2.5 / 0.34 - 4
Plug-in desk-design COMBI terminal blocks			
			
	gray gray gray blue green-yellow	PTS 1,5/S/1P PTS 1,5/S/1P BU PTS 1,5/S/1P-PE	PTS 1,5/S-TWIN/1P PTS 1,5/S-TWIN/1P BU PTS 1,5/S-TWIN/1P-PE
		3214453 3214466 3214479	3214709 3214712 3214725
Width / Length / Height	[mm]	3.5 / 50.7 / 38.5	3.5 / 50.7 / 38.5
Current / voltage // UL	[A] / [V]	17.5 // 500 / 15 / 600	17.5 // 500 / 15 / 600
rigid / AWG // flexible / AWG	[mm ²] / [-]	0.14 - 1.5 / 26 - 14 // 0.14 - 1.5 / 26 - 14	0.14 - 1.5 / 26 - 14 // 0.14 - 1.5 / 26 - 14
Stranded with ferrule without / with plastic sleeve	[mm ²]	0.14 - 1.5 / 0.14 - 1	0.14 - 1.5 / 0.14 - 1
Directly pluggable: with ferrule / rigid	[mm ²]	0.34 - 1.5 / 0.25 - 1.5	0.34 - 1.5 / 0.25 - 1.5
			
	gray gray blue green-yellow	PTTBS 1,5/S/2P PTTBS 1,5/S/2P-PV PTTBS 1,5/S/2P BU PTTBS 1,5/S/2P-PE	PTTBS 2,5-TWIN/2P PTTBS 2,5-TWIN/2P-PV PTTBS 2,5-TWIN/2P BU PTTBS 2,5-TWIN/2P-PE
		3214495 3214521 3214505 3214518	3210604 3210607 3210605 3210606
Width / Length / Height	[mm]	3.5 / 78 / 55	5.2 / 111.8 / 55
Current / voltage // UL	[A] / [V]	16 // 500 / 15 / 600	18 // 500 / 20 / 600
rigid / AWG // flexible / AWG	[mm ²] / [-]	0.14 - 1.5 / 26 - 14 // 0.14 - 1.5 / 26 - 14	0.14 - 4 / 26 - 12 // 0.14 - 2.5 / 26 - 14
Stranded with ferrule without / with plastic sleeve	[mm ²]	0.14 - 1.5 / 0.14 - 1	0.14 - 2.5 / 0.14 - 2.5
Directly pluggable: with ferrule / rigid	[mm ²]	0.34 - 1.5 / 0.25 - 1.5	0.34 - 2.5 / 0.34 - 4











PT plug-in terminal blocks

Plug-in COMBI PIN/PIN terminal blocks							
	gray blue green-yellow	PT 1,5/S/2P PT 1,5/S/2P BU PT 1,5/S/2P-PE	3213784 3213797 3213810	ST 2,5/2P ST 2,5/2P BU ST 2,5/2P-PE	3042133 3042094 3042146	ST 4/2P ST 4/2P BU ST 4/2P-PE	3042735 3043789 3042748
Width / Length / Height	[mm]	3.5 / 45.8 / 32	5.2 / 49.1 / 36.5	6.2 / 55.9 / 36.5			
Current / voltage // UL	[A] / [V]	17.5 // 500 / 15 / 600	24 // 500 / 20 / 600	32 // 800 / - / -			
rigid / AWG // flexible / AWG	[mm²] / [-]	0.14 - 1.5 / 26 - 14 // 0.14 - 1.5 / 26 - 14	0.08 - 4 / 28 - 12 // 0.08 - 2.5 / 28 - 14	0.08 - 6 / 28 - 10 // 0.08 - 4 / 28 - 12			
Stranded with ferrule without / with plastic sleeve	[mm²]	0.14 - 1.5 / 0.14 - 1	0.14 - 2.5 / 0.14 - 2.5	0.14 - 4 / 0.14 - 4			
Directly pluggable: with ferrule / rigid	[mm²]	0.34 - 1.5 / 0.25 - 1.5	- / -	- / -			
	gray gray blue green-yellow	ST 2,5-QUATTRO/4P ST 2,5-QUATTRO/4P BU	3042159 3042081	PTTB 1,5/S/4P PTTB 1,5/S/4P-PV PTTB 1,5/S/4P BU PTTB 1,5/S/4P-PE	3213865 3213852 3213878 3213881	STTB 2,5/4P STTB 2,5/4P-PV STTB 2,5/4P BU STTB 2,5/4P-PE	3061486 3061509 3061512 3061499
Width / Length / Height	[mm]	5.2 / 89.5 / 36.5	3.5 / 93.9 / 42.6	5.2 / 98.8 / 47.5			
Current / voltage // UL	[A] / [V]	24 // 500 / 20 / 600	16 // 500 / 15 / 600	22 // 500 / 20 / 600			
rigid / AWG // flexible / AWG	[mm²] / [-]	0.08 - 4 / 28 - 12 // 0.08 - 2.5 / 28 - 14	0.14 - 1.5 / 26 - 14 // 0.14 - 1.5 / 26 - 14	0.08 - 4 / 28 - 12 // 0.08 - 2.5 / 28 - 14			
Stranded with ferrule without / with plastic sleeve	[mm²]	0.14 - 2.5 / 0.14 - 2.5	0.14 - 1.5 / 0.14 - 1	0.14 - 2.5 / 0.14 - 2.5			
Directly pluggable: with ferrule / rigid	[mm²]	- / -	0.34 - 1.5 / 0.25 - 1.5	- / -			
COMBI couplings with a spring-cage connection							
	gray gray gray gray gray gray	PPC 1,5/S/ 2 PPC 1,5/S/ 3 PPC 1,5/S/ 4 PPC 1,5/S/ 5 PPC 1,5/S/ 6	3213386 3213399 3213409 3213412 3213425	PPC 2,5/2 PPC 2,5/3 PPC 2,5/4 PPC 2,5/5 PPC 2,5/6	3000656 3000657 3000658 3000659 3000660	PPC 2,5/10 PPC 2,5/11 PPC 2,5/12 PPC 2,5/13 PPC 2,5/14	3000664 3000665 3000666 3000667 3000668
Width / Length / Height	[mm]	7 / 27 / 17.8	10.4 / 20.5 / 41	51.5 / 20.5 / 41			
Current / voltage // UL	[A] / [V]	17.5 // 500 / 15 / 600	24 // 500 / 20 / 300	24 // 500 / 20 / 300			
rigid / AWG // flexible / AWG	[mm²] / [-]	0.14 - 1.5 / 26 - 14 // 0.14 - 1.5 / 26 - 14	0.14 - 4 / 26 - 12 // 0.14 - 2.5 / 26 - 14	0.14 - 4 / 26 - 12 // 0.14 - 2.5 / 26 - 14			
Stranded with ferrule without / with plastic sleeve	[mm²]	0.14 - 1.5 / 0.14 - 1	- / 0.14 - 2.5	- / 0.14 - 2.5			
Directly pluggable: with ferrule / rigid	[mm²]	0.34 - 1.5 / 0.25 - 1.5	0.34 - 2.5 / 0.34 - 4	0.34 - 2.5 / 0.34 - 4			

PT plug-in terminal blocks

					
	gray gray gray gray gray blue green-yellow	PPC 2,5/1-L PPC 2,5/1-L BU PPC 2,5/1-L GNYE	3000653 3000654 3000655	PPC 6/2 PPC 6/3 PPC 6/4 PPC 6/5 PPC 6/6	3000693 3000694 3000695 3000697 3000698
Width / Length / Height	[mm]	5.2 / 20.5 / 41	16.4 / 47 / 24.7		
Current / voltage // UL	[A] / [V]	24 // 500 / 20 / 300	41 // 1,000 / 40 / 600		
rigid / AWG // flexible / AWG	[mm ²] / [-]	0.14 - 4 / 26 - 12 // 0.14 - 2.5 / 26 - 14	0.5 - 10 / 20 - 8 // 0.5 - 6 / 20 - 10		
Stranded with ferrule without / with plastic sleeve	[mm ²]	- / 0.14 - 2.5	0.5 - 6 / 0.5 - 6		
Directly pluggable: with ferrule / rigid	[mm ²]	0.34 - 2.5 / 0.34 - 4	1 - 6 / 1 - 10		
Self-assembly COMBI couplings					
					
	gray blue green-yellow green/yellow	PPC 1,5/S/1-L PPC 1,5/S/1-L BU PPC 1,5/S/1-L GNYE	3213357 3213360 3213373	PPC 6/1-L PPC 6/1-L BU PPC 6/1-L GNYE	3000690 3000691 3000692
Width / Length / Height	[mm]	3.5 / 27 / 17.8	8.2 / 47 / 24.7		
Current / voltage // UL	[A] / [V]	17.5 // 500 / 15 / 600	41 // 1,000 / 40 / 600		
rigid / AWG // flexible / AWG	[mm ²] / [-]	0.14 - 1.5 / 26 - 14 // 0.14 - 1.5 / 26 - 14	0.5 - 10 / 20 - 8 // 0.5 - 6 / 20 - 10		
Stranded with ferrule without / with plastic sleeve	[mm ²]	0.14 - 1.5 / 0.14 - 1	0.5 - 6 / 0.5 - 6		
Directly pluggable: with ferrule / rigid	[mm ²]	0.34 - 1.5 / 0.25 - 1.5	1 - 6 / 1 - 10		
Self-assembly COMBI couplings for DIN rail mounting					
					
	gray	PPC 1,5/S-NS/1-L	3213700	PPC 2,5-NS/1-L	3000652
				PPC 6-NS/1-L	3000689
Width / Length / Height	[mm]	3.5 / 43 / 28.3	5.2 / 41 / 35.2	8.2 / 43 / 38	
Current / voltage // UL	[A] / [V]	17.5 // 500 / 15 / 600	24 // 500 / 20 / 300	41 // 1,000 / 40 / 600	
rigid / AWG // flexible / AWG	[mm ²] / [-]	0.14 - 1.5 / 26 - 14 // 0.14 - 1.5 / 26 - 14	0.14 - 4 / 26 - 12 // 0.14 - 2.5 / 26 - 14	0.5 - 10 / 20 - 8 // 0.5 - 6 / 20 - 10	
Stranded with ferrule without / with plastic sleeve	[mm ²]	0.14 - 1.5 / 0.14 - 1	- / 0.14 - 2.5	0.5 - 6 / 0.5 - 6	
Directly pluggable: with ferrule / rigid	[mm ²]	0.34 - 1.5 / 0.25 - 1.5	0.34 - 2.5 / 0.34 - 4	1 - 6 / 1 - 10	

PT plug-in terminal blocks

COMBI connectors							
	gray gray blue green-yellow	PP 2,5/ 1 PP 2,5/ 1-L PP 2,5/ 1-L BU PP 2,5/ 1-L GNYE	3211280 3211271 3211272 3211273	PP 2,5/ 1-M PP 2,5/ 1-M BU PP 2,5/ 1-M GNYE	3211274 3211275 3211276	PP 2,5/ 1-R PP 2,5/ 1-R BU PP 2,5/ 1-R GNYE	3211277 3211278 3211279
Width / Length / Height	[mm]	5.2 / 16 / 41.2	5.2 / 16 / 41.2	5.2 / 16 / 41.2			
Current / voltage // UL	[A] / [V]	24 // 800 / 20 / 600	24 // 800 / 20 / 600	24 // 800 / 20 / 600			
rigid / AWG // flexible / AWG	[mm²] / [-]	0.14 - 4 / 26 - 12 // 0.14 - 2.5 / 26 - 14	0.14 - 4 / 26 - 12 // 0.14 - 2.5 / 26 - 14	0.14 - 4 / 26 - 12 // 0.14 - 2.5 / 26 - 14			
Stranded with ferrule without / with plastic sleeve	[mm²]	0.14 - 2.5 / 0.14 - 2.5	0.14 - 2.5 / 0.14 - 2.5	0.14 - 2.5 / 0.14 - 2.5			
Directly pluggable: with ferrule / rigid	[mm²]	0.34 - 2.5 / 0.34 - 4	0.34 - 2.5 / 0.34 - 4	0.34 - 2.5 / 0.34 - 4			
							
	gray gray gray gray gray	PP 2,5/ 2 PP 2,5/ 3 PP 2,5/ 4 PP 2,5/ 5 PP 2,5/ 6	3211281 3211282 3211283 3211284 3211285	PP-H 1,5/S/1 PP-H 1,5/S/2 PP-H 1,5/S/3 PP-H 1,5/S/4 PP-H 1,5/S/5	3212484 3212510 3212523 3212536 3212549	PP-H 2,5/ 1 PP-H 2,5/ 2 PP-H 2,5/ 3 (1GNYE/2GY) PP-H 2,5/ 4 PP-H 2,5/ 5	3209866 3209879 3209883 3209895 3209905
Width / Length / Height	[mm]	10.4 / 16 / 41.2	3.5 / 16.5 / 31.3	5.2 / 15.8 / 40.2			
Current / voltage // UL	[A] / [V]	24 // 800 / 20 / 600	17.5 // 500 / 15 / 600	24 // 500 / 20 / 600			
rigid / AWG // flexible / AWG	[mm²] / [-]	0.14 - 4 / 26 - 12 // 0.14 - 2.5 / 26 - 14	0.14 - 1.5 / 26 - 14 // 0.14 - 1.5 / 26 - 14	0.14 - 4 / 26 - 12 // 0.14 - 2.5 / 26 - 14			
Stranded with ferrule without / with plastic sleeve	[mm²]	0.14 - 2.5 / 0.14 - 2.5	0.14 - 1.5 / 0.14 - 1	0.14 - 2.5 / 0.14 - 2.5			
Directly pluggable: with ferrule / rigid	[mm²]	0.34 - 2.5 / 0.34 - 4	0.34 - 1.5 / 0.25 - 1.5	0.34 - 2.5 / 0.34 - 4			
							
	gray gray gray gray gray	PP-H 4/ 1 PP-H 4/ 2 PP-H 4/ 3 PP-H 4/ 4 PP-H 4/ 5	3212010 3212016 3212022 3212029 3212035				
Width / Length / Height	[mm]	6.2 / 21 / 42.3					
Current / voltage // UL	[A] / [V]	32 // 800 / 28 / 600					
rigid / AWG // flexible / AWG	[mm²] / [-]	0.2 - 6 / 24 - 10 // 0.2 - 4 / 24 - 12					
Stranded with ferrule without / with plastic sleeve	[mm²]	0.25 - 4 / 0.25 - 4					
Directly pluggable: with ferrule / rigid	[mm²]	0.5 - 4 / 0.5 - 6					
COMBI connectors for self-assembly							
	gray gray gray	PP-H 1,5/S/1-L PP-H 1,5/S/1-M PP-H 1,5/S/1-R	3212659 3212688 3212714	PP-H 2,5/1-L PP-H 2,5/1-M PP-H 2,5/1-R	3210062 3210091 3210127	PP-H 4/ 1-L PP-H 4/ 1-M PP-H 4/ 1-R	3211948 3211965 3211977
Width / Length / Height	[mm]	3.5 / 16.5 / 31.3	5.2 / 15.8 / 40.2	6.2 / 21 / 42.3			
Current / voltage // UL	[A] / [V]	17.5 // 500 / 15 / 600	24 // 500 / 20 / 600	32 // 800 / 28 / 600			
rigid / AWG // flexible / AWG	[mm²] / [-]	0.14 - 1.5 / 26 - 14 // 0.14 - 1.5 / 26 - 14	0.14 - 4 / 26 - 12 // 0.14 - 2.5 / 26 - 14	0.2 - 6 / 24 - 10 // 0.2 - 4 / 24 - 12			
Stranded with ferrule without / with plastic sleeve	[mm²]	0.14 - 1.5 / 0.14 - 1	0.14 - 2.5 / 0.14 - 2.5	0.25 - 4 / 0.25 - 4			
Directly pluggable: with ferrule / rigid	[mm²]	0.34 - 1.5 / 0.25 - 1.5	0.34 - 2.5 / 0.34 - 4	0.5 - 4 / 0.5 - 6			

PT plug-in terminal blocks

				
	gray	PP-H 6/ 1-L	3061664	
	gray	PP-H 6/ 1-M	3061693	
	gray	PP-H 6/ 1-R	3061729	
Width / Length / Height	[mm]	8.2 / 21 / 49.3		
Current / voltage // UL	[A] / [V]	41 // 1,000 / 40 / 600		
rigid / AWG // flexible / AWG	[mm ²] / [-]	0.5 - 10 / 20 - 8 // 0.5 - 6 / 20 - 10		
Stranded with ferrule without / with plastic sleeve	[mm ²]	0.5 - 6 / 0.5 - 6		
Directly pluggable: with ferrule / rigid	[mm ²]	1 - 6 / 1 - 10		

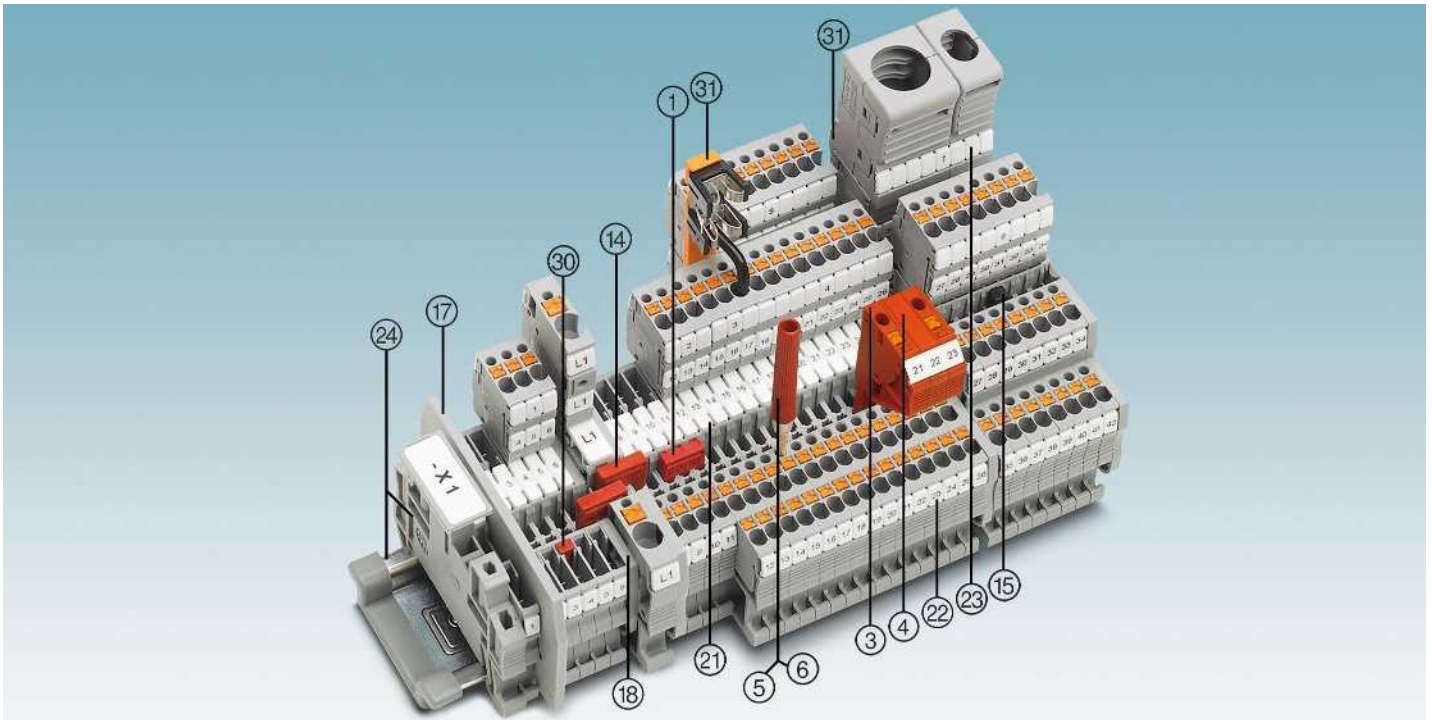

Figure reference

Web code:

① Plug-in bridges	#2284
③ Modular test plug	#2285
④ Spacer plates for PS...	#2286
⑤ Test plug metal part	#2287
⑥ Insulating sleeve for MPS metal part	#2288
⑭ Reducing bridges	#2291
⑮ Vertical potential bridges	#2292
⑰ Partition plates/end cover segments	#2294
⑱ Cover	#2294
⑳ Center groove labeling	#1087
㉑ Center and side groove labeling	#1087
㉒ Lateral groove marking	#1087
㉓ DIN rails and end brackets	#2296
㉔ Coding profile	#2302
㉕ Latching mechanisms, strain relief fixtures, and cable housings	#2301

The full range of accessories is available at phoenixcontact.net/products

In dialog with customers and partners worldwide

Phoenix Contact is a globally present, Germany-based market leader. Our group is synonym for future-oriented components, systems, and solutions in the fields of electrical engineering, electronics, and automation. A global network across more than 100 countries, and 17,400 employees ensure a close proximity to our customers, which we believe is particularly important.

The wide variety of our innovative products makes it easy for our customers to find future-oriented solutions for different applications and industries. We especially focus on the fields of energy, infrastructure, process and factory automation.



You will find our complete product range at:
phoenixcontact.com

PHOENIX CONTACT GmbH & Co. KG
Flachmarktstraße 8
32825 Blomberg, Germany
Phone: +49 52 35 3-00
Fax: +49 52 35 3-4 12 00
E-mail: info@phoenixcontact.com
phoenixcontact.com

单击下面可查看定价，库存，交付和生命周期等信息

[>>Phoenix Contact \(菲尼克斯\)](#)