

Electronic housing - ME 22,5 UT GN - 2907130

Please be informed that the data shown in this PDF Document is generated from our Online Catalog. Please find the complete data in the user's documentation. Our General Terms of Use for Downloads are valid (<http://download.phoenixcontact.com>)



Lower part of housing, fully assembled, with metal foot catch.

Why buy this product

- Tool-free mounting
- Low design width with a high number of positions
- Large assembly area
- Same PCB geometry for all design widths
- Recessed labeling areas
- Inflammability class V0 according to UL 94
- Fast mounting on DIN rails according to EN 60715
- Material and part identification embossed on the housing (recyclability)
- Cost savings thanks to easy device production
- Functional earth ground contact (EMC) integrated in the housing base
- Electronic components can be partially removed
- Metal foot catch
- Optional BUS connection integrated in the housing, for either parallel or serial contacting



Key commercial data

Packing unit	1
Minimum order quantity	10
Catalog page	Page 601 (CC-2011)
GTIN	 4 017918 126629
Custom tariff number	85369010
Country of origin	GERMANY

Technical data

General

Housing type	Component housing
Housing material	Polyamide
Color	green

Electronic housing - ME 22,5 UT GN - 2907130

Technical data

Dimensions / positions

Length	99 mm
Constructional height	114.5 mm
Width	22.5 mm
Number of positions	16
Number of positions	24

Technical data

Ambient temperature (operation)	-40 °C ... 105 °C
Inflammability class according to UL 94	V0
Power dissipation at 20°C in the horizontal mounting position	6.1 W 12.1 W

Classifications

ETIM

ETIM 2.0	EC001031
ETIM 3.0	EC001031
ETIM 4.0	EC001031
ETIM 5.0	EC001031

UNSPSC

UNSPSC 11	31261501
UNSPSC 12.01	31261501
UNSPSC 13.2	31261501
UNSPSC 6.01	31261501
UNSPSC 7.0901	31261501

eCl@ss

eCl@ss 4.0	27180401
eCl@ss 4.1	27180401
eCl@ss 5.0	27180506
eCl@ss 5.1	27180506
eCl@ss 6.0	27180802
eCl@ss 7.0	27182702

Approvals

Approvals

Approvals

UL Recognized

Ex Approvals

Electronic housing - ME 22,5 UT GN - 2907130

Approvals

Approvals submitted

Approval details

UL Recognized 

Accessories

Accessories

Assembly

Electronic housing - ME 45 UTM GN - 2853404



Intermediate element for modular extension of the volume of the housing in the pitch. The open intermediate element is 22.5 mm wide.

Electronic housing - ME 45 UTMG GN - 2853417



Intermediate element for modular extension of the volume of the housing in the pitch. The closed intermediate element is 22.5 mm wide.

Electronic housing - ME-SAS - 2853899



Shield connection clamp for printed circuit terminal block

Electronic housing - ME LPZS - 2906911



PCB stop, for soldering onto PCB

Electronic housing - ME 22,5 UT GN - 2907130

Accessories

Electronic housing - ME B-22,5 MKDSO GN - 2907143



Filler plugs, for unoccupied terminal points

Electronic housing - ME B-22,5 MSTBO GN - 2907156



Filler plugs, for unoccupied terminal points

Electronic housing - ME MF 17,5 - 2908281



Metal foot catch, for intermediate elements.

Electronic housing - ME B-12,5 3MSTBO GN - 2709176

Filler plugs, for unoccupied terminal points

Electronic housing - ME MF 17,5 - 2908281



Metal foot catch, for intermediate elements.

Electronic housing - ME 45 UTM GN - 2853404



Intermediate element for modular extension of the volume of the housing in the pitch. The open intermediate element is 22.5 mm wide.

Plug/Adapter

Electronic housing - ME 22,5 UT GN - 2907130

Accessories

Keying star - CR-MSTB - 1734401



Coding section, inserted into the recess in the header or the inverted plug, red insulating material

Coding profile - CP-MSTB - 1734634



Keying profile, is inserted into the slot on the plug or inverted header, red insulating material

Electronic housing - ME FE-CONTACT - 2908294



Functional earth ground contact, for intermediate elements.

Electronic housing - ME FE-CONTACT - 2908294



Functional earth ground contact, for intermediate elements.

Electronic housing - ME LP - 2906908

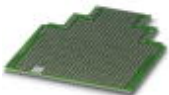

PCB, for custom fitting, with contact to DIN rail (EN 60715)

Necessary add-on products

Electronic housing - ME 22,5 UT GN - 2907130

Accessories

Electronic housing - ME 22,5 OT-MSTBO SET - 2907444

Housing upper part, complete with 4 pairs of COMBICON headers and plugs



Electronic housing - ME 22,5 OT-1MSTBO GN - 2709558

Upper part of housing, for COMBICON connection, single-level



Electronic housing - ME 22,5 OT-MSTBO GN - 2907169

Upper part of housing, for COMBICON connection, double-level



Electronic housing - ME 22,5 OT-MKDSO GN - 2907172

Housing upper part, for printed circuit terminal block connection



Electronic housing - ME 22,5 OT-MKDSO SET - 2907473

Housing upper part, complete with PCB termination blocks for full equipping. 16-pos., housing width: 22.5 mm



Drawings

Electronic housing - ME 22,5 UT GN - 2907130

Dimensioned drawing

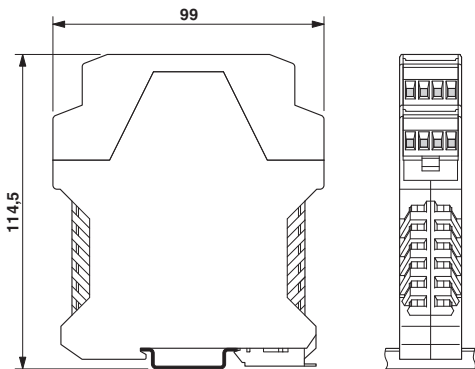

Dimensioned drawing

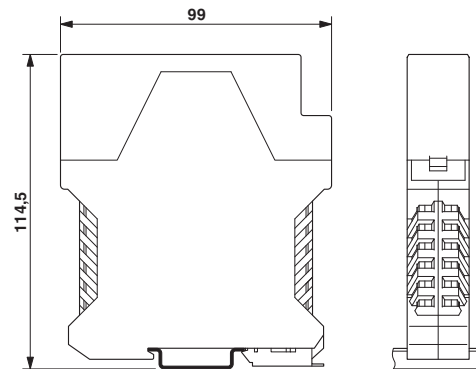

Dimensions of the electronic housing ME... with double-level upper part

Dimensions of the electronic housing ME... with single-level upper part

Dimensioned drawing

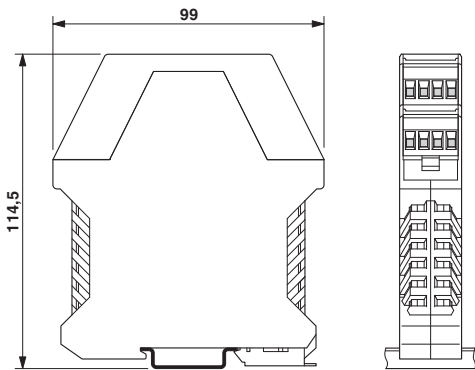

Dimensioned drawing

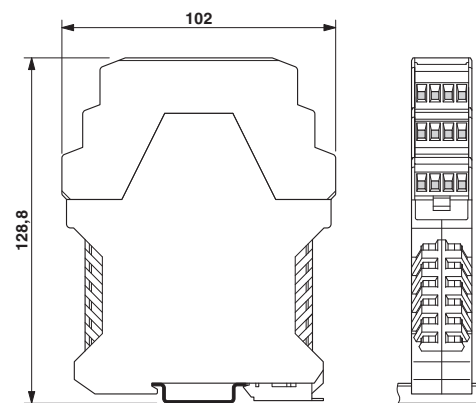

Dimensions of the electronic housing ME... with double-level upper part

Dimensional drawing of the ME... printed circuit board if the triple-level upper part is used

Dimensioned drawing

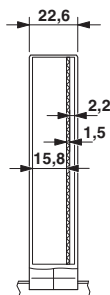

Inner housing dimensions, electronic housing ME 22.5 ...

Electronic housing - ME 22,5 UT GN - 2907130

Dimensioned drawing

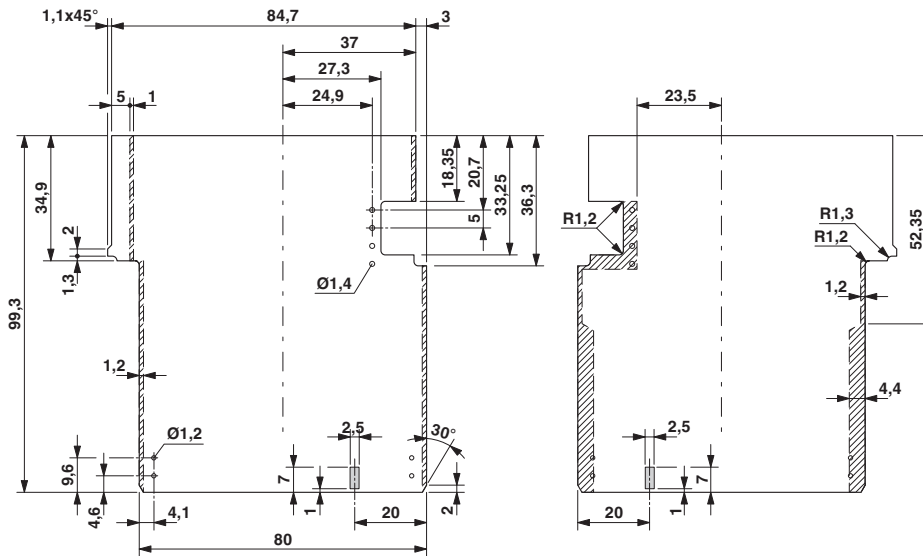

Dimensional drawing of the ME... printed circuit board if the single level upper part is used

Dimensioned drawing

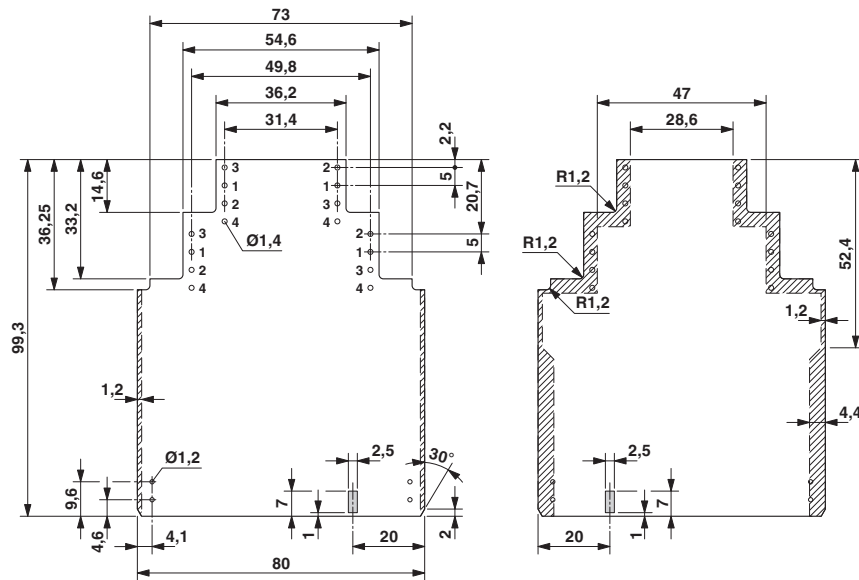

Dimensional drawing of the ME... printed circuit board if the double level upper part is used

Electronic housing - ME 22,5 UT GN - 2907130

Dimensioned drawing

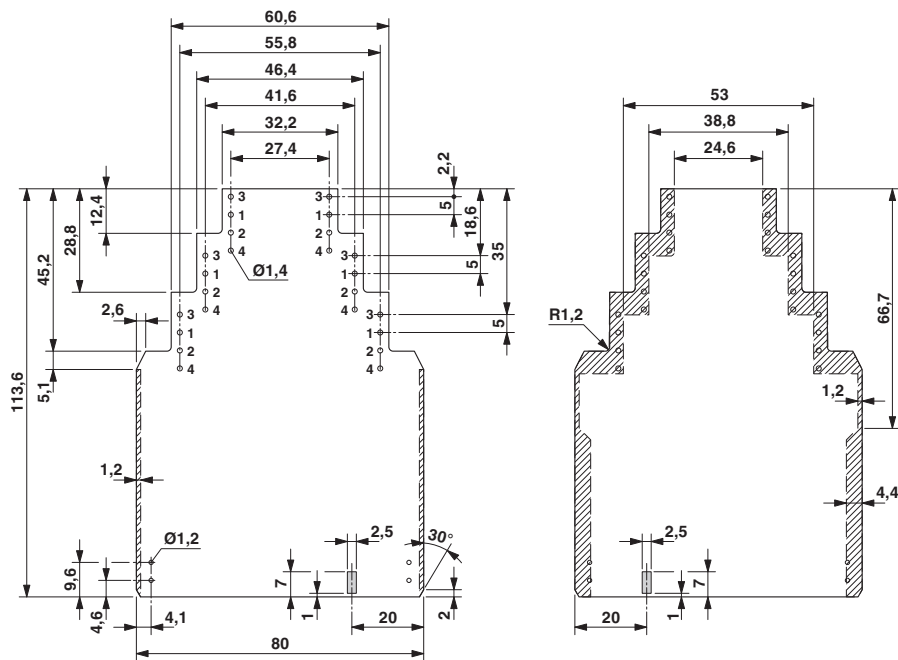

Dimensional drawing of the ME... printed circuit board if the triple-level upper part is used

© Phoenix Contact 2012 - all rights reserved
<http://www.phoenixcontact.com>

单击下面可查看定价，库存，交付和生命周期等信息

[>>Phoenix Contact\(菲尼克斯\)](#)