

**Features and Benefits**

- Magnetic technology offers robust performance.
- 100% Non-contacting design (no bearings or bushings) provides an extremely long life and is tolerant to harsh environments.
- Simple two piece design (target magnet + encoder) for easy alignment and installation.
- Bi-directional two channel incremental quadrature output.
- Mounting holes for a 2-bolt or 3-bolt pattern Ø 1.811" BHC x 0.125" O.D.
- Magnet rotor for standard shaft sizes from 2 mm to 1/2". Custom bore sizes available.
- Options up to 30 pulse per channel per revolution.
- Customizable lead wires, cables, and or connectors.

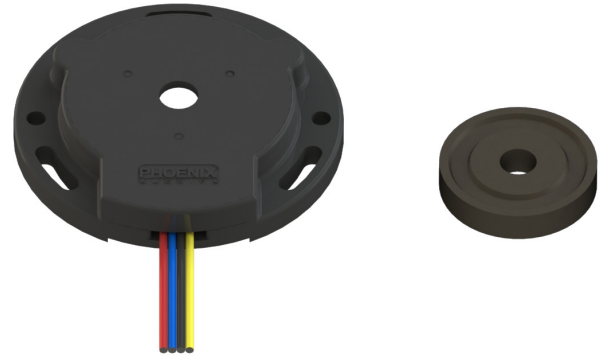

Kit - Encoder with Target Magnet

*Shown with shaft pass through hole  
Wire color order varies with part configuration*

**Application Example**

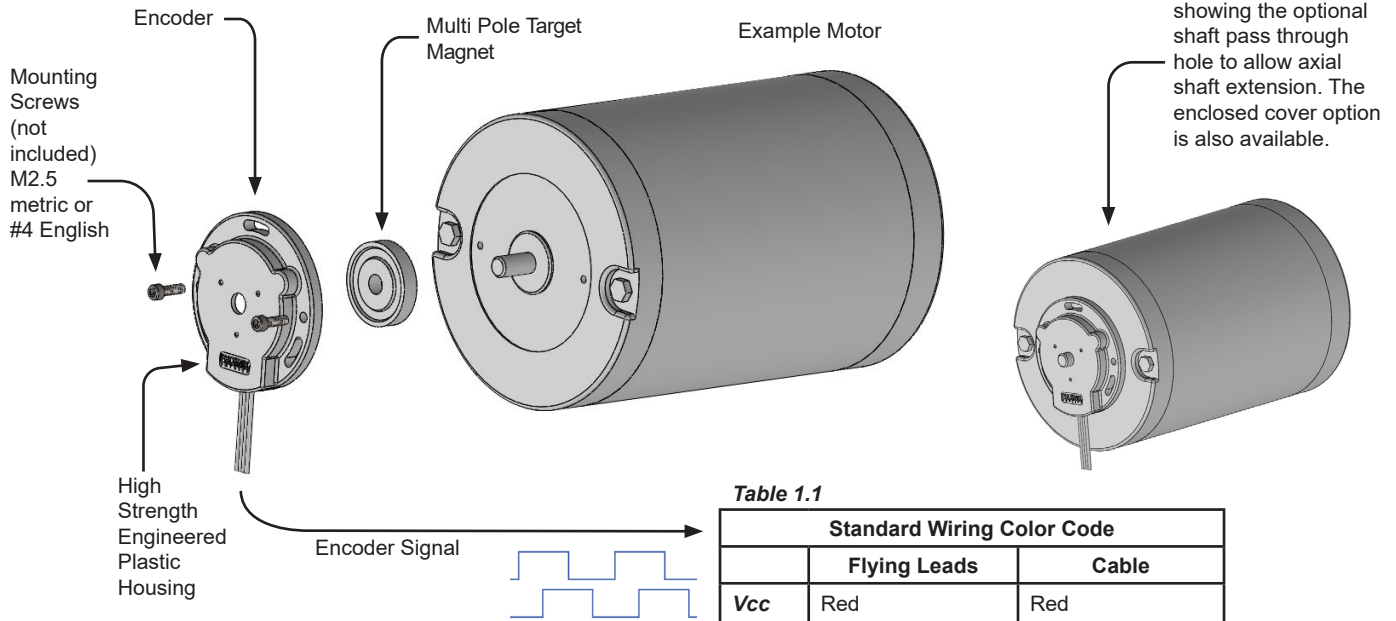

**Table 1.1**

Standard Wiring Color Code		
	Flying Leads	Cable
<b>Vcc</b>	Red	Red
<b>Gnd</b>	Black	Black
<b>Ch A</b>	Yellow	Brown
<b>Ch B</b>	Blue	Orange

*Other colors available upon request.  
Contact [sales@phoenixamerica.com](mailto:sales@phoenixamerica.com).*

**Output Waveforms**

**Clockwise Rotation**

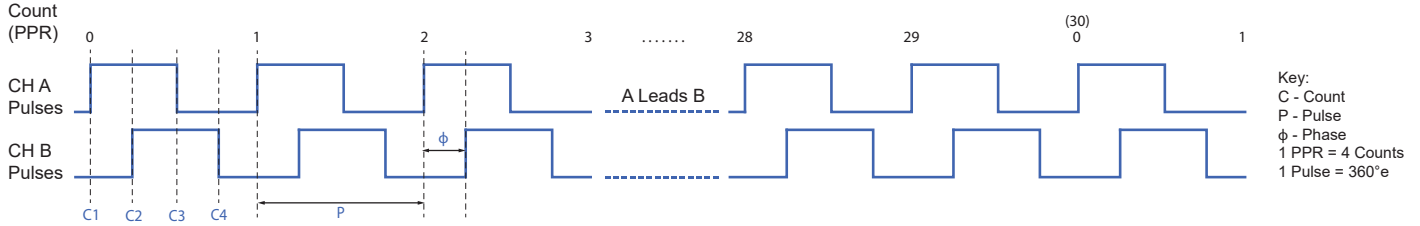

**Counterclockwise Rotation**

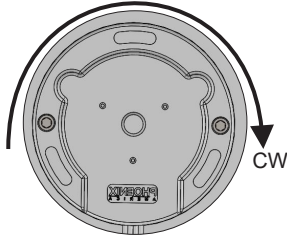
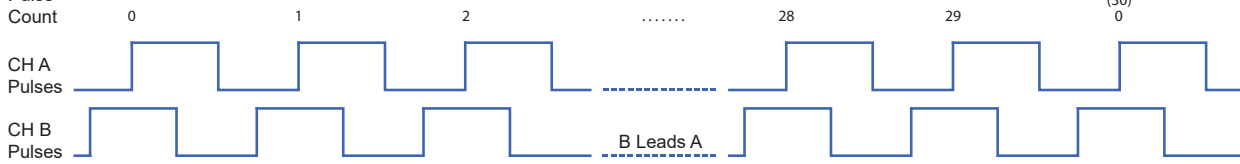

Phase direction is dependent on specified resolution. Shaft rotation is defined when looking at the branded face of the encoder. See Table 2.1 below.

**Table 2.1**

Shaft Rotation	Resolution PPR - Pulses Per Revolution
Channel A leads Channel B	3, 7, 12, 14, 15, 19, 22, 30
Channel B leads Channel A	1, 2, 4, 5, 6, 8, 9, 10, 16, 17, 18, 20, 25, 26

**Absolute Maximum Ratings**

**Table 2.2**

Characteristic	Symbol	Rating	Units
Forward Supply Voltage	$V_{CC}$	26.5	V
Reverse Supply Voltage	$V_{RCC}$	-30	V
Output Off Voltage	$V_{OUT}$	26	V
Continuous Output Current	$I_{OUT}$	25	mA
Reverse Output Current	$I_{ROUT}$	-50	mA
Operating Temperature	$T_A$	-40 - 125	°C
Storage Temperature	$T_S$	-40 - 150	°C

**Electrical Characteristics**

**Table 2.3**

Characteristic	Symbol	Test Conditions	Min.	Typ. <sup>1</sup>	Max.	Unit <sup>2</sup>
Forward Supply Voltage	$V_{CC}$	Operating, $T_J < 165\text{ °C}$	3.3	-	24	V
Power-On Time	$t_{PO}$	$V_{CC} > 3.3V$	-	-	25	$\mu s$
Supply Current	$I_{CC(ON)}$	$B > B_{OP}, V_{CC} = 12V$	-	-	8	mA
	$I_{CC(OFF)}$	$B < B_{RP}, V_{CC} = 12V$	-	-	8	mA
Reverse Supply Current	$I_{RRC}$	$V_{RRC} = -30V$	-	-	-5	mA

**Electrical Circuit**

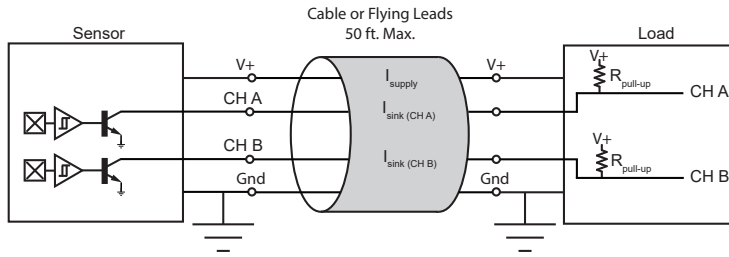

Output channels require customer supplied pull-up resistors unless internal pull-up option is selected. See Table 3.1 for recommended resistor values.

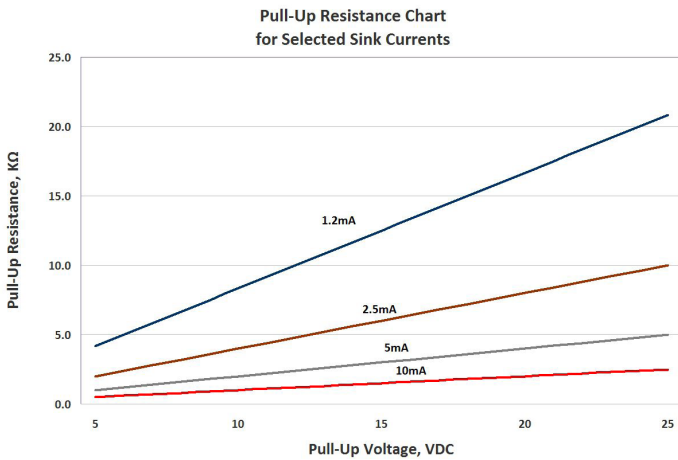

**Table 3.1**

Recommended Pull-Up Resistor Values			
Current, I <sub>sink</sub>	Supply Voltage		
	5	12	24
1.2 mA	4.3K	10.0K	20.0K
2.5 mA	2.0K	4.7K	10.0K
5 mA	1.0K	2.4K	4.7K
10 mA	510Ω	1.2K	2.4K

I<sub>sink</sub> is application dependent. It is recommended to use the lowest possible sink current when selecting a pull-up resistor.

Theoretical Pull-Up Resistor Calculation:  $R_{pullup} = \frac{V_{supply}}{I_{sink}}$

Resistance values based on closest standard 5% resistor values

Absolute Maximum I<sub>sink</sub> = 20mA

4.7 K pull-up is available as a standard option. If an alternative pull-up value is preferred, contact sales@phoenixamerica.com.

**Wiring**

FLYING LEADS

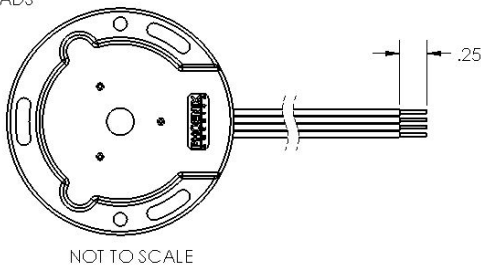

- 24 AWG
- 7x32 Strands, Tinned Copper
- PVC Insulation
- MIL M16878/1
- Temperature Rating: 105°C

CABLE

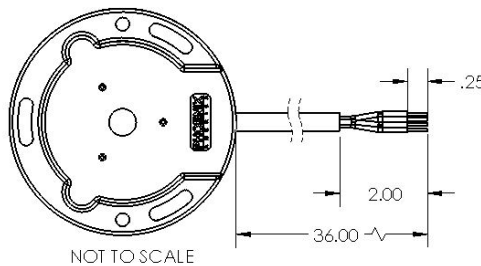

- 24 AWG
- 4 Conductor with Foil Shield and Drain
- Stranded Tinned Copper
- PVC Insulation
- Grey PVC Jacket
- UL Style 2464, CSA
- Temperature Rating: 105°C

Custom lengths and insulation materials available. Contact sales@phoenixamerica.com.

**Table 3.2**

Standard Wiring			
	Leads	Cable	Connector Pin-Out
<b>Ch A</b>	Yellow	Brown	1
<b>Ch B</b>	Blue	Orange	2
<b>Gnd</b>	Black	Black	3
<b>Vcc</b>	Red	Red	4

**Encoder Physical Outline**

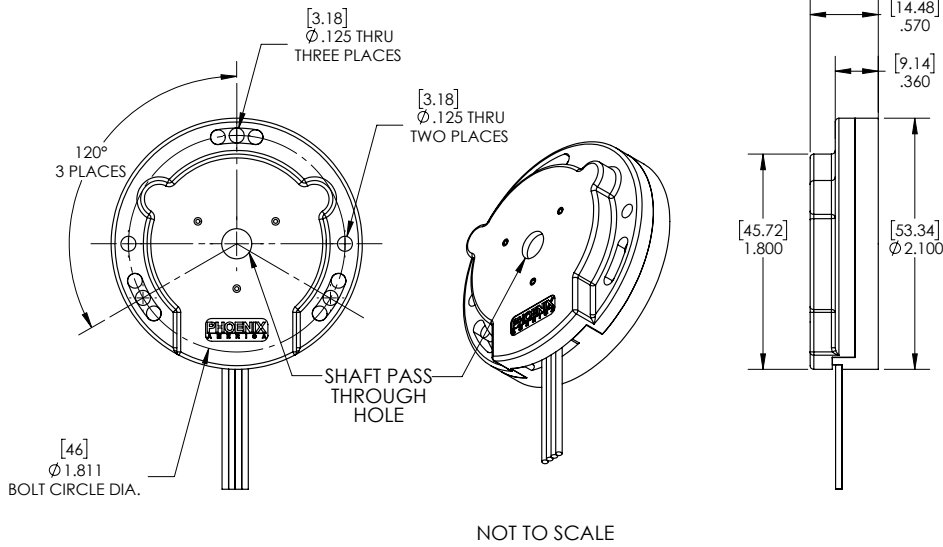

**Table 4.1**

Motor Shaft Diameter	Shaft Pass Through Hole Size (options/recommendation)	
	No Hole	
-	No Hole	
2 mm	2.06 mm	0.081 in
3 mm	3.06 mm	0.120 in
1/8 in	3.26 mm	0.127 in
5/32 in	4.06 mm	0.160 in
4 mm	4.06 mm	0.160 in
3/16 in	4.83 mm	0.190 in
5 mm	5.06 mm	0.199 in
6 mm	6.06 mm	0.239 in
1/4 in	6.40 mm	0.252 in
7 mm	7.06 mm	0.278 in
5/16 in	8.05 mm	0.317 in
8 mm	8.05 mm	0.317 in
3/8 in	9.59 mm	0.378 in
10 mm	10.06 mm	0.396 in
12 mm	12.06 mm	0.475 in
1/2 in	12.76 mm	0.502 in

Other shaft pass through hole sizes available upon request. Contact [sales@phoenixamerica.com](mailto:sales@phoenixamerica.com).

**Encoder Mounting Guidelines**

Concentricity of the encoder housing to the target magnet is critical for optimal encoder performance. Considering the following during the design phase will ensure concentricity and ease of assembly.

- Tight molding tolerances allow for the outside diameter of the encoder to be used to locate the encoder housing concentric to the motor shaft and target magnet. A machined pocket on the motor endbell works well for alignment. Recommended pocket is 0.015" to 0.020" deep and 2.11" in diameter.
- Extending the shaft through the optional shaft pass through hole is an easy way to align the encoder housing to the motor shaft and target magnet. Simply position the encoder so that the shaft is centered concentrically in the shaft pass through hole.
- If previous two methods of alignment are not used it is recommended that the encoder be fastened to the motor using #5-40 or M3 mounting screws. The slightly larger diameter of the #5-40 and M3 screws will compensate for some of the tolerance allowed when using the standard recommended #4-40 or M2.5 mounting screws.

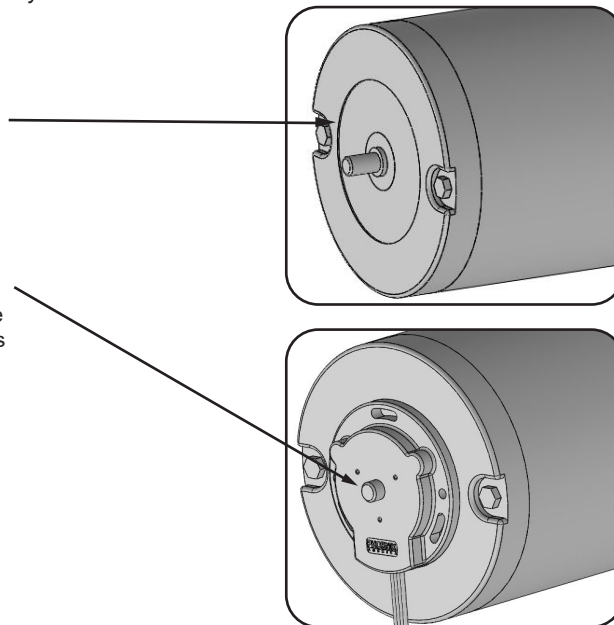

**Target Magnet Physical Outline - AS Molded (Mounting Style A)**

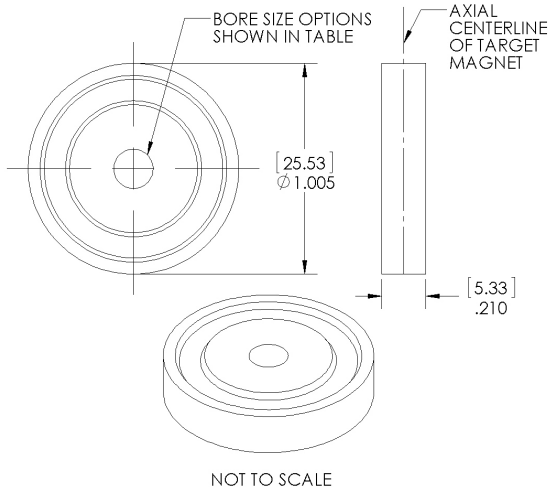

**Table 5.1**

Bore Size (.inch)	Motor Shaft OD Size (nominal)	NEMA Guide Shaft Tolerance	Magnet Bore MIN. (inch)	Magnet Bore MAX. (inch)
079	2 mm (.0787")	+0.0000"/-0.0005"	.0777	.0807
118	3 mm (.1181")		.1171	.1201
125	1/8 in (.1250")		.1240	.1270
156	5/32 in (.1563")		.1553	.1583
157	4 mm (.1575")		.1565	.1595
188	3/16 in (.1875")		.1865	.1895
197	5 mm (.1969")		.1959	.1989
236	6 mm (.2364")		.2354	.2384
250	1/4 in (.2500")		.2490	.2520
276	7 mm (.2758")		.2747	.2777
313	5/16 in (.3125")		.3115	.3145
315	8 mm (.3150")		.3140	.3170
375	3/8 in (.3750")		.3740	.3770
394	10 mm (.3940")		.3930	.3960
473	12 mm (.4728")		.4718	.4748
500	1/2 in (.5000")		.4990	.5020

Other bore sizes available upon request.  
Contact [sales@phoenixamerica.com](mailto:sales@phoenixamerica.com).

**Target Magnet Mounting Guidelines - Molded (Mounting Style A) For Slip Fit Application**

- Proper alignment of the magnet rotor to the encoder sensing element is critical for optimal encoder performance. Insure that the target magnet is mounted to the specified height shown in the diagram below.
- A machined step on the motor shaft provides a quick and repeatable method for positioning the target magnet. Spacers or other fixturing should be used to properly position the magnet if no mechanical locating features are on the shaft.
- Various adhesives can be used to bond the target magnet to the motor shaft. Shaft alloys, operating environment, and shaft speed and acceleration should be taken into consideration when selecting an appropriate bonding agent. Loctite threadlockers and retaining compounds have proven effective in bonding the target magnet to the motor shaft. Loctite 263 and 2760 threadlockers and Loctite 638 and 680 retaining compounds are good candidates. These materials have been effective in past experience; testing under actual operating conditions should be used to qualify any bonding material.
- For best results, the motor shaft should be clean and free of any oils, lubricants, or solvents.
- Apply adhesive around the leading edge of the shaft and inside the hole in the rotor. Use a rotating motion when assembling the target magnet to the shaft to insure good adhesive coverage.
- The use of primers and activators can be used to improve bond strength and cure rate.
- For non-critical applications or for fast bonding for evaluation, a cyanoacrylate adhesive (super glue) can be used. Loctite 401 and 410 have proven effective for quick bonding applications.

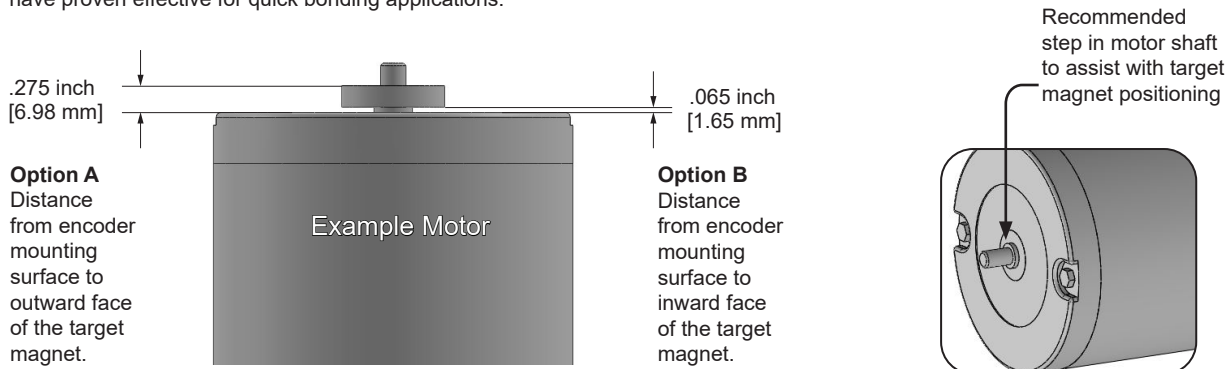

**Target Magnet Physical Outline - Universal Hub (Mounting Style U)**

A universal hub kit is available to provide a range of bore sizes to fit several popular industry shaft diameters.

Kit contents (*not shown to scale*)

Includes 2 of each size for closed cover option.

Includes 3 of each size for shaft pass through option.

Hubs

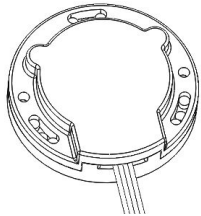
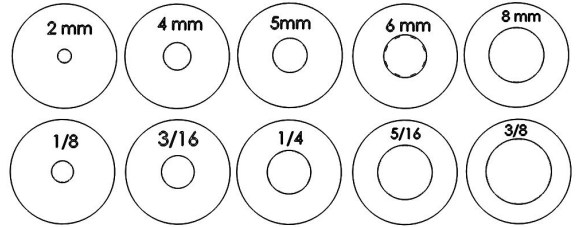

Encoder



Magnet Insertion Tool

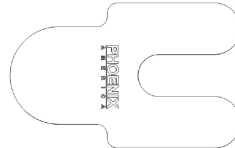

Spacer Gap Tool

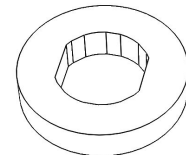

Target Magnet

**Assembly Guidelines**

**Without shaft pass-through option**

Step 1

Attach two of the desired hub size on each side of the magnet. Make sure the flats are in-line with each other.

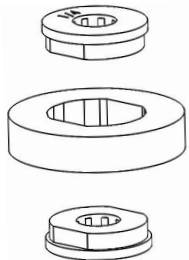

Step 2

Use the insertion tool to push the magnet assembly **straight** onto the shaft until the bottom face of the hub is resting on the gap tool.

*tip* - Support the bottom of the motor with a fixture or holding clamp.

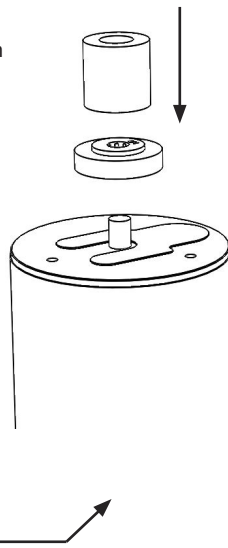

Step 3

Place the encoder onto the motor and secure with #4 or M3 screws.

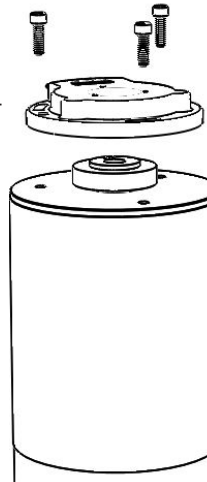

Step 4

Manually spin the shaft to verify that the shaft/magnet is not interfering with the encoder.

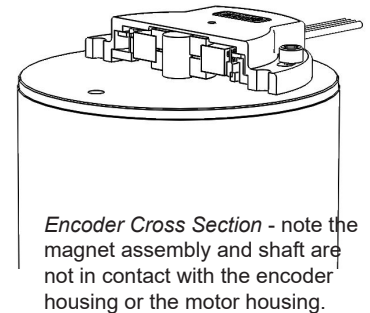

**With shaft pass-through option**

*For applications that require the shaft to pass through the encoder, an optional hole is located in the top of the encoder housing.*

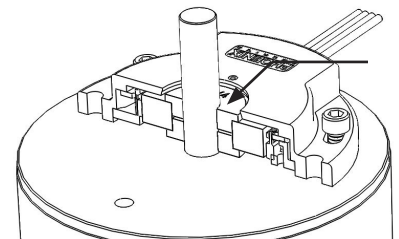
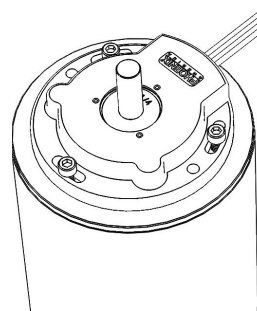
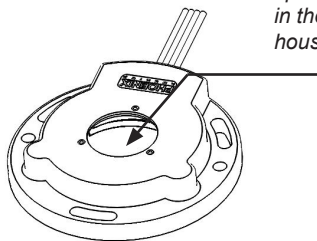



**Connector Options**

Molex Mini-Fit Jr. (Male)

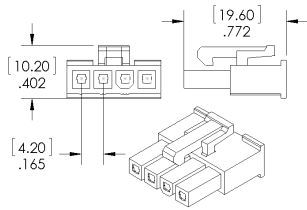

Molex Mini-Fit Jr. (Female)

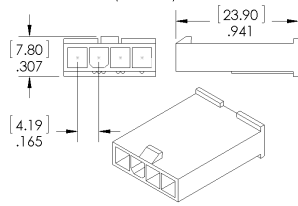

TE AmpModu MTE (Male)

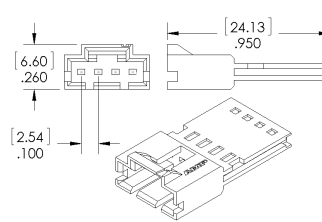

TE AmpModu MTE (Female)

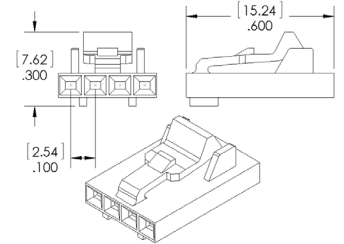

Need a different connector? Contact [sales@phoenixamerica.com](mailto:sales@phoenixamerica.com).

**Part Number Description**

**L8 - 0030 - 0188 - 05 - N - C - N - A - F - B - XX**

Series	PPR	Bore Size	Supply Voltage	Index	Output Type	Shaft Pass Through Hole	Target Magnet Mounting	Wiring	Length (Meters)	Connector
L8	0001 0016 0002 0017 0003 0018 0004 0019 0005 0020 0006 0022 0007 0025 0008 0026 0009 0030 0010 0012 0014 0015	0000 Universal Hub 0079 2 mm 0118 3 mm 0125 1/8 in 0156 5/32 in 0157 4 mm 0188 3/16 in (default) 0197 5 mm 0236 6 mm 0250 1/4 in 0276 7 mm 0313 5/16 in 0315 8 mm 0375 3/8 in 0394 10 mm 0473 12 mm 0500 1/2 in	05 5V (default)	N No (default) Y Yes	C Open Collector (default)  S Open Collector with Internal 4.7k Pull Up Resistor	N None (default)  Y Size will match bore shown in Table 4.1	A AS Molded (default)  U Universal Hub	F Flying Leads (default)  C Cable	A .5 (19.685") B 0.914 (36") (default) C 1 (39.370") D 2 (78.740")	XX None (default) A1 TE AmpModu MTE (Male) A2 TE AmpModu MTE (Female) M1 Molex Mini-Fit Jr. (Male) M2 Molex Mini-Fit Jr. (Female)

Example: L8-0030-0188-05-N-C-N-A-F-B-M2

单击下面可查看定价，库存，交付和生命周期等信息

[>>Phoenix Contact\(菲尼克斯\)](#)