

# ILB IB 24 DO16-DSUB



**Inline Block IO Module  
for INTERBUS With 16 Digital Outputs;  
Bus Connection via D-SUB Connectors**

**AUTOMATIONWORX**

Data Sheet  
7119\_en\_02

© PHOENIX CONTACT - 03/2007

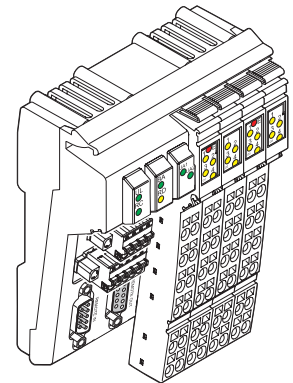

## Description

The ILB IB 24 DO16-DSUB module is designed for use within an INTERBUS network. It is used to output digital signals.

### INTERBUS Features

- Remote bus connection via D-SUB connector
- 500 kbps transmission speed
- Diagnostic and status indicators

### Output Features

- Connections for 16 digital actuators
- Connection of actuators in 2 and 3-wire technology
- Nominal current per output: 0.5 A
- Total current of all outputs: 8 A
- Short-circuit and overload protected outputs
- Diagnostic and status indicators



Please refer to the "Mounting and Removing Inline Block IO Modules" application note (see "Ordering Data" on page 2).



Make sure you always use the latest documentation.  
It can be downloaded at [www.download.phoenixcontact.com](http://www.download.phoenixcontact.com).

A conversion table is available on the Internet at  
[www.download.phoenixcontact.com/general/7000\\_en\\_00.pdf](http://www.download.phoenixcontact.com/general/7000_en_00.pdf).

## Ordering Data

### Product

Description	Type	Order No.	Pcs./Pkt.
Inline Block IO module for INTERBUS with 16 digital outputs; bus connection via D-SUB connectors	ILB IB 24 DO16-DSUB	2878528	1

### Accessories: Connectors

Description	Type	Order No.	Pcs./Pkt.
D-SUB connector (female connector), solder connection	SUBCON 9/F-SH	2761499	1
D-SUB connector (male connector), solder connection	SUBCON 9/M-SH	2761509	1

### Accessories: Connectors as Replacement Item

Description	Type	Order No.	Pcs./Pkt.
Connector for the supply (4-pos. MINI COMBICON)	FK-MCP 1,5/5-STF-3,81	1851258	50
Connector for the supply (5-pos. MINI COMBICON)	FK-MCP 1,5/6-STF-3,81	1851261	50
Connector for digital 4-channel or 16-channel Inline output terminals, with color print	IB IL SCN-12-OCF	2727624	10

### Accessories: Other

Description	Type	Order No.	Pcs./Pkt.
Recommended end clamp; placed both to the right and left of the module to secure it on the DIN rail	CLIPFIX 35-5	3022276	50

### Documentation

Description	Type	Order No.	Pcs./Pkt.
"Mounting and Removing Inline Block IO Modules" application note	AH ILB INSTALLATION	9014931	1
"INTERBUS Addressing" data sheet	DB GB IBS SYS ADDRESS	9000990	1
"Addressing of 16-Channel ILB Modules" application note	AH ILB 24 DI/DO 16 ADDRESS	9014962	1
"General Introduction to the INTERBUS System" user manual	IBS SYS INTRO G4 UM E	2745211	1
"Configuring and Installing INTERBUS" user manual	IBS SYS PRO INST UM E	2743802	1
"Configuring and Installing the INTERBUS Inline Product Range" user manual	IB IL SYS PRO UM E	2743048	1

## Technical Data

### General Data

Housing dimensions with connectors (width x height x depth)	95 mm x 55 mm x 141 mm
Weight	254 g (with connectors)
Operating mode	Process data mode with 1 word
Transmission speed	500 kbps
Connection method for actuators	2 and 3-wire technology

### Housing Dimensions

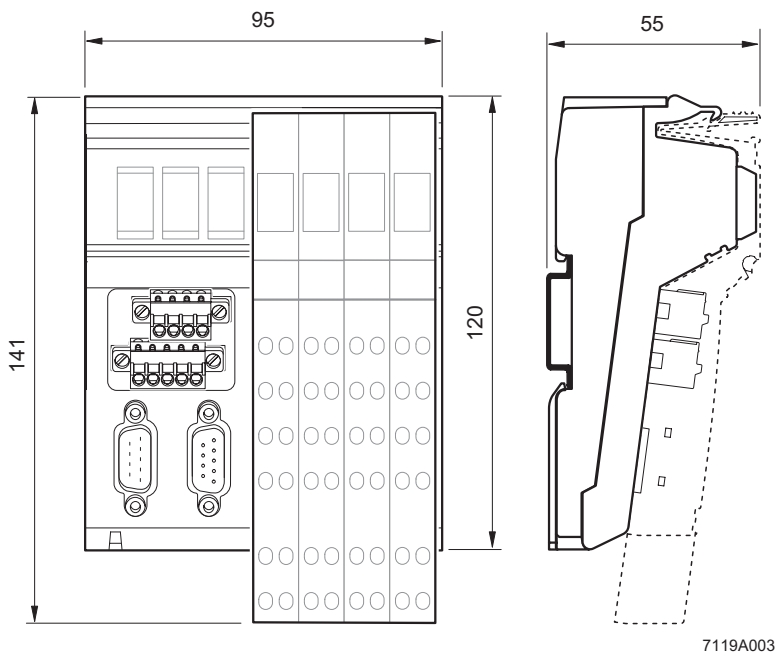

Figure 1 Housing dimensions of the module (dimensions in mm)

### Ambient Conditions

Regulations	Developed according to VDE 0160/EN 50178/IEC 62103, UL 508
Ambient temperature (operation)	-25°C to +60°C
Ambient temperature (storage/transport)	-25°C to +85°C
Humidity (operation/storage/transport)	10% to 95%, according to EN 61131-2
Air pressure (operation)	80 kPa to 108 kPa (up to 2000 m above sea level)
Air pressure (storage/transport)	66 kPa to 108 kPa (up to 3500 m above sea level)
Degree of protection according to IEC 60529	IP20
Class of protection	Class 3 according to VDE 0106/IEC 60536
Air and creepage distances	According to DIN VDE 0110/IEC 60664, IEC 60664A, DIN VDE 0160/EN 50178/IEC 62103
Housing material	Plastic, PVC-free, PBT, self-extinguishing (V0)
Pollution degree according to EN 60664-1/IEC 60664-1, EN 61131-2/IEC 61131-2	2; condensation not permitted during operation
Surge voltage class	II

**Electrical Isolation/Isolation of the Voltage Areas**

Test Distance	Test Voltage
Incoming remote bus / outgoing remote bus	500 V AC, 50 Hz, 1 min
Incoming remote bus / I/O	500 V AC, 50 Hz, 1 min
Incoming remote bus / functional earth ground	500 V AC, 50 Hz, 1 min
Outgoing remote bus / I/O	500 V AC, 50 Hz, 1 min
Outgoing remote bus / functional earth ground	500 V AC, 50 Hz, 1 min
I/O / functional earth ground	500 V AC, 50 Hz, 1 min

**Mechanical Requirements**

Vibration test, sinusoidal vibrations according to EN 60068-2-6/IEC 60068-2-6	5g load, 2.5 hours in each space direction
Shock test according to EN 60068-2-27/IEC 60068-2-27	25g load for 11 ms, half sinusoidal wave, 3 shocks in each space direction and orientation
Broadband noise according to EN 60068-2-64/IEC 60068-2-64	0.78g load, 2.5 hours in each space direction

**Conformance With EMC Directive 89/336/EEC**

**Noise Immunity Test According to EN 61000-6-2**

Electrostatic discharge (ESD)	EN 61000-4-2 IEC 61000-4-2	Criterion B 6 kV contact discharge 8 kV air discharge
Electromagnetic fields	EN 61000-4-3 IEC 61000-4-3	Criterion A Field strength: 10 V/m
Fast transients (burst)	EN 61000-4-4/ IEC 61000-4-4	Criterion B Remote bus: 2 kV Power supply: 2 kV I/O cables: 2 kV Criterion A All interfaces: 1 kV
Surge voltage	EN 61000-4-5 IEC 61000-4-5	Criterion B DC supply lines: ± 0.5 kV/± 1.0 kV (symmetrical/asymmetrical) Signal lines: ± 0.5 kV/± 0.5 kV (symmetrical/asymmetrical)
Conducted interference	EN 61000-4-6 IEC 61000-4-6	Criterion A Test voltage 10 V

**Noise Emission Test According to EN 61000-6-4**

Noise emission of housing	EN 55022	Class B (residential)
---------------------------	----------	-----------------------

**Interface: INTERBUS**

Incoming remote bus	Copper cable (RS-422), connected via 9-pos. D-SUB connector; supply electrically isolated; shielding connected with a capacitor to functional earth ground
Outgoing remote bus	Copper cable (RS-422), connected via 9-pos. D-SUB connector; supply electrically isolated; shielding directly connected to functional earth ground
Recommended cable lengths	See INTERBUS system data in the IBS SYS INTRO G4 UM E user manual

**24 V Module Supply (Communications Power and Actuator Supply; U<sub>L</sub> and U<sub>A</sub>)**

Nominal value	24 V DC
Tolerance	- 15%/+ 20% according to EN 61131-2
Ripple	±5% according to EN 61131-2
Permissible range	19.2 V DC to 30.0 V DC
Current consumption at U <sub>L</sub>	70 mA
Current consumption at U <sub>A1</sub> and U <sub>A2</sub>	8 A
Safety equipment for communications power	Surge protection and protection against polarity reversal
Safety equipment for actuator supply	Surge protection
Connection	Via MINI-COMBICON connector

**Digital Outputs**

Number	16
Connection method for actuators	2 and 3-wire technology
Nominal output voltage U <sub>OUT</sub>	24 V DC
Differential voltage at I <sub>nom</sub>	≤ 1 V
Nominal current I <sub>nom</sub> per channel	0.5 A
Total current	2 x 4 A
Protection	Short-circuit and overload protection
Nominal load	
Ohmic	48 Ω / 12 W
Lamp	12 W
Inductive	12 VA (1.2 H, 50 Ω)
Switching frequency with nominal inductive load	0.5 Hz (1.2 H, 50 Ω), maximum
Overload response	Auto restart
Response with inductive overload	Output may be damaged
Reverse voltage protection against short pulses	Protected against reverse voltages
Resistance to permanently applied reverse voltages	Protected against reverse voltages, permissible current 2 A, maximum
Validity of output data after connecting the 24 V voltage supply (power up)	1 ms, typical
Response upon power down	The output follows the supply voltage without delay.
Limitation of the voltage induced on circuit interruption	-41.0 V
One-time unsolicited energy	1 J, maximum
Protective circuit type	Integrated free running circuit in the output chip
Overcurrent shutdown	0.7 A, minimum
Maximum output current when switched off	10 μA



When not loaded, a voltage can be measured even at an output that is not set.

**Typical Power Dissipation With 24 V Supply Voltage**

**Formula to Calculate the Power Dissipation of the Electronics**

$P_{TOT} = 1.68 \text{ W} + \sum_{i=1}^n (0.11 \text{ W} + I_{Li}^2 \times 0.28 \text{ } \Omega)$	Where P <sub>TOT</sub> Total power dissipation of the module i Continuous index n Number of set outputs (n = 1 to 16) I <sub>Li</sub> Load current of output i
---	--

**Limitation of Simultaneity, Derating**

Ambient Temperature (TA)	Maximum Load Current (I) at 100% Simultaneity	Maximum Load Current (I) at 50% Simultaneity
-25°C to +45°C	16 x 0.5 A	8 x 0.5 A
+46°C to +60°C	$I_{tot} = 8 \text{ A} - ((TA - 45^\circ\text{C}) \times 0.267 \text{ A}/^\circ\text{C})$	8 x 0.5 A

With an ambient operating temperature of up to 45°C and 100% simultaneity, a load current of 0.5 A per channel is permissible.

If all four channels are used at a temperature of > 45°C, the permissible working point must be defined according to the above formula. An example can be found in the "Configuring and Installing the INTERBUS Inline Product Range" user manual IB IL SYS PRO UM E.

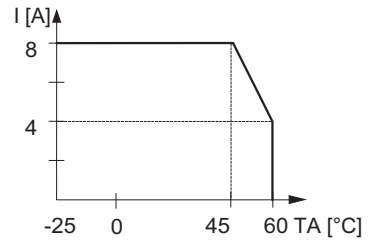

6891A012

**Approvals**

For the latest approvals, please visit [www.download.phoenixcontact.com](http://www.download.phoenixcontact.com).

### Internal Circuit Diagram

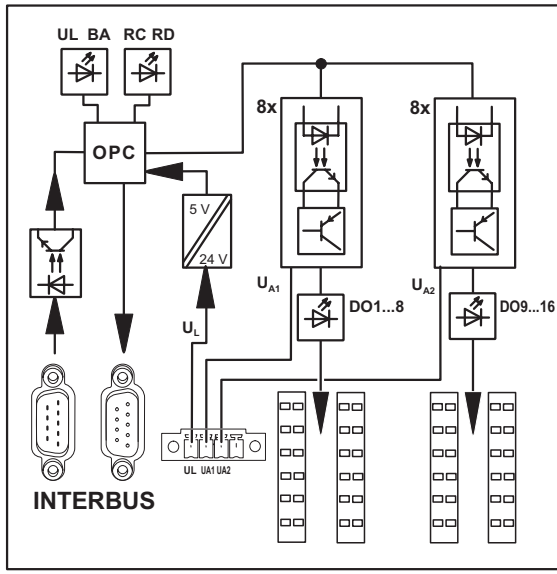







Figure 2 Internal wiring of the terminal points

Key:

-  LED
-  Protocol chip (bus logic)
-  Power supply unit with electrical isolation
-  Optocoupler
-  Short-circuit-proof output

### Local Diagnostic and Status Indicators

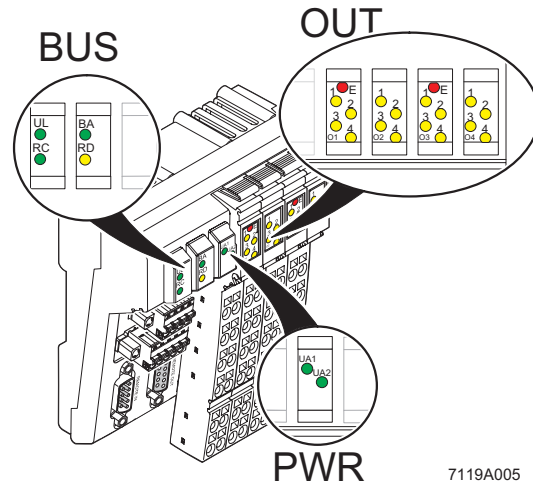

Figure 3 Diagnostic and status indicators of the ILB IB 24 DO16-DSUB module

Designation	Color	Meaning
<b>BUS</b>		
<b>UL</b>	Green	Communications power
<b>RC</b>	Green	Remote bus cable check
<b>BA</b>	Green	Bus active
<b>RD</b>	Yellow	Outgoing remote bus disabled
<b>PWR</b>		
<b>UA1</b>	Green	Actuator supply 1 (connector 5 and connector 6 for actuators)
<b>UA2</b>	Green	Actuator supply 2 (connector 7 and connector 8 for actuators)
<b>OUT</b>		
<b>E</b>	Red	Short circuit or overload at one of the outputs
<b>1 to 4</b>	Yellow	Status indicators of the outputs



If the error LED (E) of a group of eight outputs lights up (e.g., connector 5 and connector 6), this indicates that a short circuit or overload is present at one or more of the outputs in this group.

### Connecting INTERBUS, the Supply, and Actuators

### Terminal Point Assignment of the MINI COMBICON Connectors for the Connection of the Supply Voltages (Connectors X1 and X2 in Figure 4 on page 8)

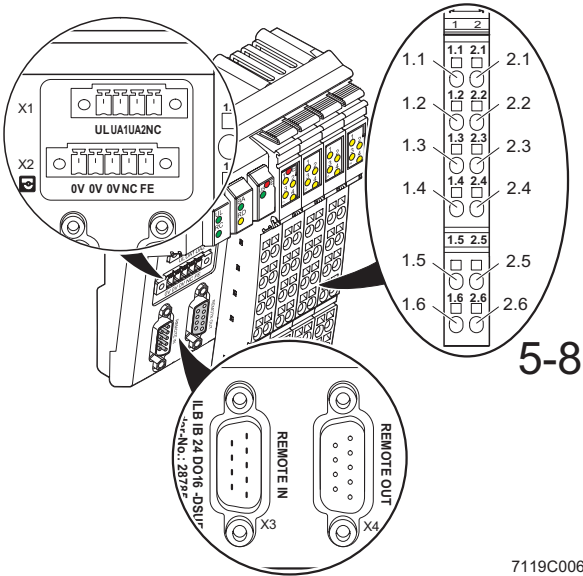

Figure 4 Terminal point assignment of the connectors

Terminal Point	Assignment
UL	24 V communications power $U_L$
UA1	24 V actuator supply $U_{A1}$
UA2	24 V actuator supply $U_{A2}$
NC	Not used

Terminal Point	Assignment
0V	GND
0V	GND
0V	GND
NC	Not used
FE	Functional earth ground



The terminal points for GND (0V) can have a total current of 8 A per terminal point. The maximum current carrying capacity of 8 A must not be exceeded. If the total output current in your application is > 8 A, the module is to be supplied via a minimum of two GND terminal points (0V).



The supply points have the same ground potential. All ground supplies on a module are electrically connected with one another. The communications power is also electrically connected via all contacts. In this way it can supply all potentials with just one supply without the need for additional terminals, see "Connection example" on page 10.



Terminal Point Assignment of the INTERBUS Connectors (Connectors X 3 and X4 in Figure 4 on page 8)

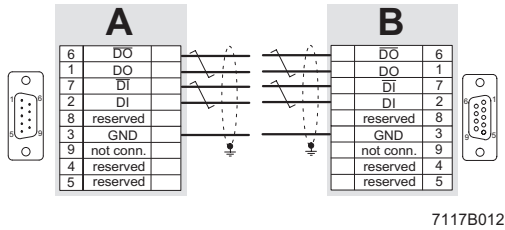

7117B012

Figure 5 Assignment of the remote bus interfaces (D-SUB connector)

- A Remote OUT (outgoing remote bus)
- B Remote IN (incoming remote bus)

Assignment	Remark/Wire Color in the INTERBUS Standard Cable	
DO	Receive	Green
DO	Receive	Yellow
DI	Transmit	Pink
DI	Transmit	Gray
GND	Reference potential	Brown
Shield (incoming remote bus)	Shield potential is connected <b>with a capacitor</b> to functional earth ground (FE) of the potential jumper.	
Shield (outgoing remote bus)	Shield potential is <b>directly</b> connected to functional earth ground (FE) of the potential jumper.	



In order to assemble the connectors, proceed as described in the IBS SYS PRO INST UM E user manual.

Terminal Point Assignment of the Output Connectors (Connectors 5 to 8 in Figure 4 on page 8)

Terminal Point				Assignment
Connector 5 (O1)	Connector 6 (O2)	Connector 7 (O3)	Connector 8 (O4)	
1.1, 2.1	1.1, 2.1	1.1, 2.1	1.1, 2.1	Signal output (OUT)
1.2, 2.2	1.2, 2.2	1.2, 2.2	1.2, 2.2	Ground contact (GND) for 2 and 3-wire termination
1.3, 2.3	1.3, 2.3	1.3, 2.3	1.3, 2.3	FE connection for 3-wire termination
1.4, 2.4	1.4, 2.4	1.4, 2.4	1.4, 2.4	Signal output (OUT)
1.5, 2.5	1.5, 2.5	1.5, 2.5	1.5, 2.5	Ground contact (GND) for 2 and 3-wire termination
1.6, 2.6	1.6, 2.6	1.6, 2.6	1.6, 2.6	FE connection for 3-wire termination

### Connection Example

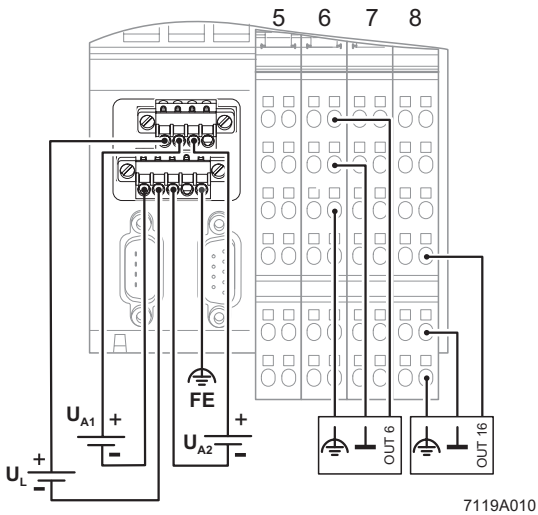

Figure 6 Connection example



The numbers above the module illustration identify the connector slots.



When connecting the actuators observe the assignment of the terminal points to the process data (see "Process Data" on page 11).



The module has an FE spring (metal clip) on the bottom of the electronics base. This spring creates an electrical connection to the DIN rail. Use grounding terminals to connect the DIN rail to protective earth ground. The module is grounded when it is snapped onto the DIN rail.

To ensure reliable functional earth grounding of the module even when the DIN rail is dirty or the metal clip is damaged, Phoenix Contact also recommends grounding the module via one of the FE terminal points.

## Programming Data

ID code	01 <sub>hex</sub> (01 <sub>dec</sub> )
Length code	01 <sub>hex</sub>
Process data channel	16 bits
Input address area	0 words
Output address area	1 word
Parameter channel (PCP)	0 words
Register length (bus)	1 word

## Process Data



For the assignment of the illustrated (byte.bit) view to your control or computer system, please refer to the DB GB IBS SYS ADDRESS data sheet.  
Please refer to the application note for addressing 16-channel ILB modules.  
The documentation can be downloaded at [www.download.phoenixcontact.com](http://www.download.phoenixcontact.com).

### Assignment of the Terminal Points to the OUT Process Data Word (Slots 5 to 8)

(Word.bit) view	Word	Word 0															
	Bit	15	14	13	12	11	10	9	8	7	6	5	4	3	2	1	0
(Byte.bit) view	Byte	Byte 0								Byte 1							
	Bit	7	6	5	4	3	2	1	0	7	6	5	4	3	2	1	0
Module	Slot	6 (O2)				5 (O1)				8 (O4)				7 (O3)			
	Terminal point (signal)	2.4	1.4	2.1	1.1	2.4	1.4	2.1	1.1	2.4	1.4	2.1	1.1	2.4	1.4	2.1	1.1
	Terminal point (GND)	2.5	1.5	2.2	1.2	2.5	1.5	2.2	1.2	2.5	1.5	2.2	1.2	2.5	1.5	2.2	1.2
	Terminal point FE	2.6	1.6	2.3	1.3	2.6	1.6	2.3	1.3	2.6	1.6	2.3	1.3	2.6	1.6	2.3	1.3
Status indicator	Slot	6				5				8				7			
	LED	4	3	2	1	4	3	2	1	4	3	2	1	4	3	2	1

## Diagnostics

### Error Table With Diagnostic Data and Status Indicators

Error Type	Diagnostic Data	Status indicators
Actuator supply U <sub>A1</sub> or U <sub>A2</sub> too low	No response	UA1 and UA2 LEDs are off
Short circuit of a digital output	I/O error message	LED E of the affected output group is red

© PHOENIX CONTACT 03/2007

单击下面可查看定价，库存，交付和生命周期等信息

[>>Phoenix Contact\(菲尼克斯\)](#)