

# Flush-type connector - SACC-DSIV-MS-8CON-L90 SCO - 1436961

Please be informed that the data shown in this PDF Document is generated from our Online Catalog. Please find the complete data in the user's documentation. Our General Terms of Use for Downloads are valid (<http://download.phoenixcontact.com>)



Sensor/actuator flush-type connector, connector, 8-pos., M12 SPEEDCON, A-coded, rear/screw mounting with M12 thread, with polarity protection, with angled solder connection



## Key commercial data

Packing unit	1 pc
Minimum order quantity	10 pc
Weight per Piece (excluding packing)	0.012 GRM
Custom tariff number	85366990
Country of origin	Germany

## Technical data

### Ambient conditions

Ambient temperature (operation)	-25 °C ... 85 °C (Plug / socket)
Degree of protection	IP67

### General

Rated current at 40°C	2 A
Rated voltage	30 V
Number of positions	8
Contact resistance	≤ 3 mΩ
Insulation resistance	≥ 100 MΩ
Coding	A - standard
Status display	No
Surge voltage category	II
Pollution degree	3
Connection method	Solder pins
Mounting type	Rear mounting M12 x 1 With flat nut

# Flush-type connector - SACC-DSIV-MS-8CON-L90 SCO - 1436961

## Technical data

### Material

Inflammability class according to UL 94	V0
Contact material	CuZn
Contact surface material	Au
Contact carrier material	PA 66
Material, knurls	Zinc die-cast, nickel-plated
Sealing material	NBR

## Classifications

### eCl@ss

eCl@ss 4.0	27250313
eCl@ss 4.1	27250313
eCl@ss 5.0	27143423
eCl@ss 5.1	27143423
eCl@ss 6.0	27143423
eCl@ss 7.0	27449001
eCl@ss 8.0	27449001

### ETIM

ETIM 3.0	EC002061
ETIM 4.0	EC002061
ETIM 5.0	EC002061

### UNSPSC

UNSPSC 6.01	31251501
UNSPSC 7.0901	31251501
UNSPSC 11	31251501
UNSPSC 12.01	31251501
UNSPSC 13.2	31251501

## Approvals

### Approvals

Approvals

UL Recognized

# Flush-type connector - SACC-DSIV-MS-8CON-L90 SCO - 1436961

## Approvals

Ex Approvals

Approvals submitted

## Approval details

UL Recognized	
mm <sup>2</sup> /AWG/kcmil	26-20
Nominal current I <sub>N</sub>	2 A
Nominal voltage U <sub>N</sub>	30 V

## Drawings

Schematic diagram

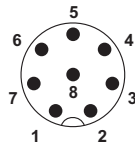

Pin assignment M12 plug, 8-pos., A-coded, view plug side

Drilling diagram

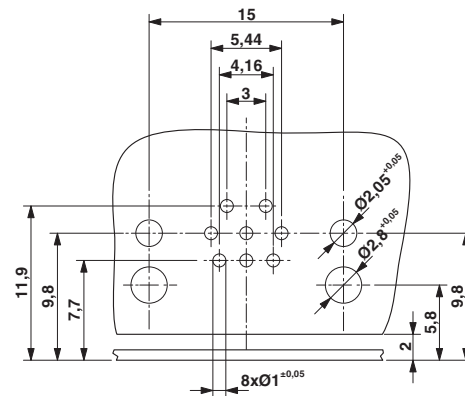

Drilling diagram

# Flush-type connector - SACC-DSIV-MS-8CON-L90 SCO - 1436961

Dimensioned drawing

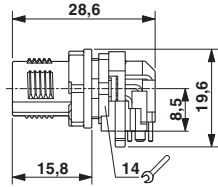

M12 flush-type connector, connector, side view

Dimensioned drawing

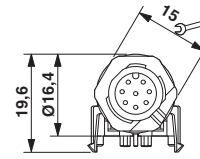

M12 flush-type connector, connector, front view

Dimensioned drawing

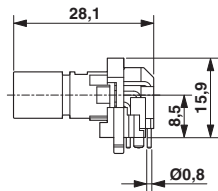

M12 flush-type connector, plug, contact carrier, side view

Dimensioned drawing

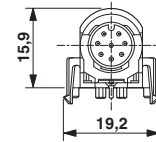

M12 flush-type connector, plug, contact carrier, front view

Dimensioned drawing

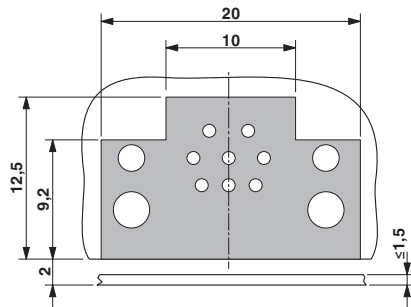

Locked area on the PCB

Dimensioned drawing

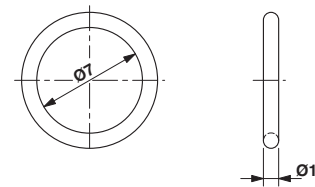

Optionally with O-ring (green) for tight seal when plugged in.  
- the axial mating force of 80 N per connector may not be exceeded when using with assembled O-ring!  
- Avoid radial forces!



单击下面可查看定价，库存，交付和生命周期等信息

[>>Phoenix Contact \(菲尼克斯\)](#)