



Web Panels with TFT-Display

User manual

User manual

Web Panels with TFT-Display

2018-10-12

Designation: UM EN BWP 2XXXX

Revision: 00

Order No.: —

This user manual is valid for:

Designation	Order No.
BWP 2043W	1060549
BWP 2070W	1060632
BWP 2102W	1060630

How to contact us

Internet

Up-to-date information on Phoenix Contact products and our Terms and Conditions can be found on the Internet at:

phoenixcontact.com

Make sure you always use the latest documentation.

It can be downloaded at:

phoenixcontact.net/products

Subsidiaries

If there are any problems that cannot be solved using the documentation, please contact your Phoenix Contact subsidiary.

Subsidiary contact information is available at phoenixcontact.com.

Published by

PHOENIX CONTACT GmbH & Co. KG
Flachsmarktstraße 8
32825 Blomberg
GERMANY

Should you have any suggestions or recommendations for improvement of the contents and layout of our manuals, please send your comments to

tecdoc@phoenixcontact.com

General terms and conditions of use for technical documentation

Phoenix Contact reserves the right to alter, correct, and/or improve the technical documentation and the products described in the technical documentation at its own discretion and without giving prior notice, insofar as this is reasonable for the user. The same applies to any technical changes that serve the purpose of technical progress.

The receipt of technical documentation (in particular user documentation) does not constitute any further duty on the part of Phoenix Contact to furnish information on modifications to products and/or technical documentation. You are responsible to verify the suitability and intended use of the products in your specific application, in particular with regard to observing the applicable standards and regulations. All information made available in the technical data is supplied without any accompanying guarantee, whether expressly mentioned, implied or tacitly assumed.

In general, the provisions of the current standard Terms and Conditions of Phoenix Contact apply exclusively, in particular as concerns any warranty liability.

This manual, including all illustrations contained herein, is copyright protected. Any changes to the contents or the publication of extracts of this document is prohibited.

Phoenix Contact reserves the right to register its own intellectual property rights for the product identifications of Phoenix Contact products that are used here. Registration of such intellectual property rights by third parties is prohibited.

Other product identifications may be afforded legal protection, even where they may not be indicated as such.

BWP 2XXXX

PHOENIX CONTACT

Table of Contents

1	Important Notes	7
1.1	Symbols	7
1.2	Safety Notes	7
1.3	Security in the network	8
1.4	Intended Use	8
1.5	Target Group	9
1.6	Licensing information on open source software	9
1.7	Retrieving the source code	9
2	Installation and Commissioning	11
2.1	Unpacking the Device	11
2.2	Mounting the Device	11
2.2.1	Mounting Cutout	13
2.2.2	Side View, Mounting Depth	16
2.3	Connecting the Device	19
2.3.1	Supply Voltage	19
2.4	Switching On	20
2.5	Identification	20
3	Control and Display Elements	21
3.1	Touchscreen	21
3.2	Display	21
4	Interfaces of the Device	23
4.1	USB (HOST)	23
4.1.1	Cable	23
4.2	Ethernet	24
4.2.1	Pin Assignment	24
4.2.2	Cable	24
5	Maintenance and Servicing	25
5.1	Front Panel	25
6	Technical Data	27
6.1	General	27
6.2	BWP 2043W	29
6.3	BWP 2070W	30
6.4	BWP 2102W	31

1 Important Notes

1.1 Symbols

The symbols in this manual are used to draw your attention on notes and dangers.



This symbol indicates hazards that could lead to personal injury.

There are three signal words indicating the severity of a potential injury.

DANGER

Indicates a hazard with a high risk level. If this hazardous situation is not avoided, it will result in death or serious injury.

WARNING

Indicates a hazard with a medium risk level. If this hazardous situation is not avoided, it could result in death or serious injury.

CAUTION

Indicates a hazard with a low risk level. If this hazardous situation is not avoided, it could result in minor or moderate injury.



This symbol together with the **NOTE** signal word alerts the reader to a situation which may cause damage or malfunction to the device, hardware/software, or surrounding property.



Here you will find additional information or detailed sources of information.

1.2 Safety Notes

- Read this manual carefully before using the operating device. Keep this manual in a place where it is always accessible to all users.
- Proper transportation, handling and storage, placement and installation of this product are prerequisites for its subsequent flawless and safe operation.
- This user manual contains the most important information for the safe operation of the device.
- The user manual, in particular the safety notes, must be observed by all personnel working with the device.
- Observe the accident prevention rules and regulations that apply to the operating site.
- Installation and operation must only be carried out by qualified and trained personnel.

1.3 Security in the network

**NOTE: Risk of unauthorized network access**

Connecting devices to a network via Ethernet always entails the risk of unauthorized access to the network.

Therefore, please check your application for any option of deactivating active communication channels. Setting passwords to prevent third parties from accessing the controller without authorization and modifying the system.

Because of the controller's communication interfaces, we advise against using the controller in safety-critical applications without additional security appliances.

Please take additional protective measures according to the IT security requirements and the standards applicable to your application (for instance virtual networks (VPN) for remote maintenance access, firewalls, etc.) for protection against unauthorized network access.

On first request, you shall release Phoenix Contact and the companies associated with Phoenix Contact GmbH & Co. KG, Flachsmarktstraße 8, 32825 Blomberg in accordance with §§ 15 ff. AktG or German Stock Corporation Act (hereinafter collectively referred to as "Phoenix Contact") from all third-party claims that are made due to improper use.

For the protection of networks for remote maintenance via VPN, Phoenix Contact offers the mGuard product series security appliances which you can find described in the latest Phoenix Contact catalog (phoenixcontact.net/products).

Additional measures for protection from unauthorized network access can be found in the AH EN INDUSTRIAL SECURITY application note. The application note can be downloaded at phoenixcontact.net/products.

1.4 Intended Use

- The device is designed for use in the industry.
- The device is state-of-the art and has been built to the latest standard safety requirements. However, dangerous situations or damage to the machine itself or other property can arise from the use of this device.
- The device fulfills the requirements of the EMC directives and harmonized European standards. Any modifications to the system can influence the EMC behavior.
- If the device is used in a manner not specified by the manufacturer, the protection provided by the equipment may be impaired.

**NOTICE: Radio Interference**

Operation of this device may cause radio interference in residential areas.

1.5 Target Group

The use of products described in this manual is oriented exclusively to:

- Qualified electricians or persons instructed by them. The users must be familiar with the relevant safety concepts of automation technology as well as applicable standards and other regulations.
- Qualified application programmers and software engineers. The users must be familiar with the relevant safety concepts of automation technology as well as applicable standards and other regulations.

1.6 Licensing information on open source software

The operating device works with a Linux operating system. License information for the individual Linux packages can be found in the web-based management of the operating device.

1.7 Retrieving the source code

This product contains software components which are licensed by the rights holder as free software or Open-source software under the GNU General Public License, version 2. You may retrieve the source code for these software components from Phoenix Contact using an appropriate storage medium (CD or DVD-ROM), by contacting After Sales Service at the address below. This must be carried out no more than three years after delivery of the product. A processing charge of 50 euros will be required in this case.

PHOENIX CONTACT GmbH & Co. KG
After Sales Service
Flachsmarktstraße 8
32825 Blomberg
GERMANY

Subject: Source code BWP 2XXXX

2 Installation and Commissioning

2.1 Unpacking the Device

Unpack all parts carefully and check the contents for any visible damage in transit. Also check whether the shipment matches the specifications on your delivery note.

If you notice damages in transit or discrepancies, please contact us immediately.

2.2 Mounting the Device

**NOTICE: Damage**

When installing the device, leave a gap of at least 30 mm (1.181") around the device to ensure sufficient air circulation.

**NOTICE: Damage**

When the operating device is installed horizontally, please note that additional sources of heat beneath the operating device may result in heat accumulation.

Make sure to allow sufficient heat dissipation!

Please observe the permissible temperature range specified in the technical data when operating the device.

**NOTICE: Damage**

In order to ensure the degree of protection specified in the technical data, observe the following points:

- A tolerance of +0,5 / -0 mm is maintained for the mounting cutout.
- The seal lies flat against the mounting surface.
- All mounting brackets are used.
- The threaded pins of the mounting brackets are tightened uniformly to a maximum torque of 0,4 Nm.

The device enables quick and easy mounting. A panel thickness of 1 mm to 6 mm is permitted for proper mounting.

1. Cut the mounting cutout in the housing for the device size to be installed.

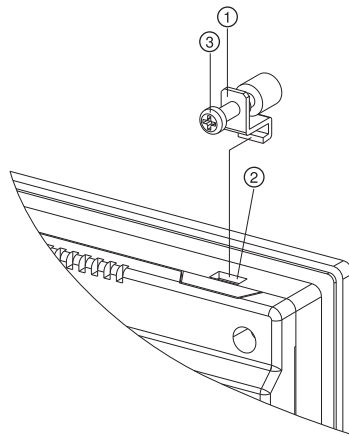

Figure 2-1 Mounting the device using a mounting clamp

2. Push the device from the front through the mounting cutout.
3. Ensure that the gasket is properly positioned in the groove and against the panel.
4. Insert the mounting clamps (1) into the recesses (2) provided.
5. Tighten the screws (3) on all mounting clamps, alternating from one side to the other until the front bezel is secure against the installation surface. Torque the screws to 0,4 Nm.

2.2.1 Mounting Cutout

2.2.1.1 BWP 2043W

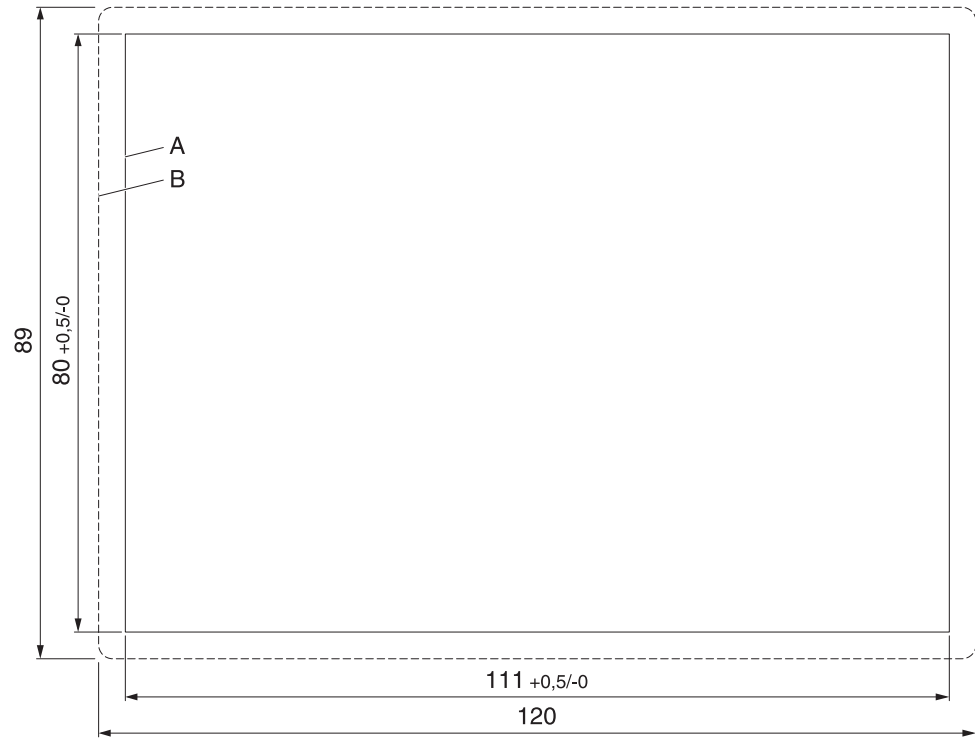

Figure 2-2 Mounting cutout (dimensions in mm)

A Mounting Cutout

B Front Panel

2.2.1.2 BWP 2070W

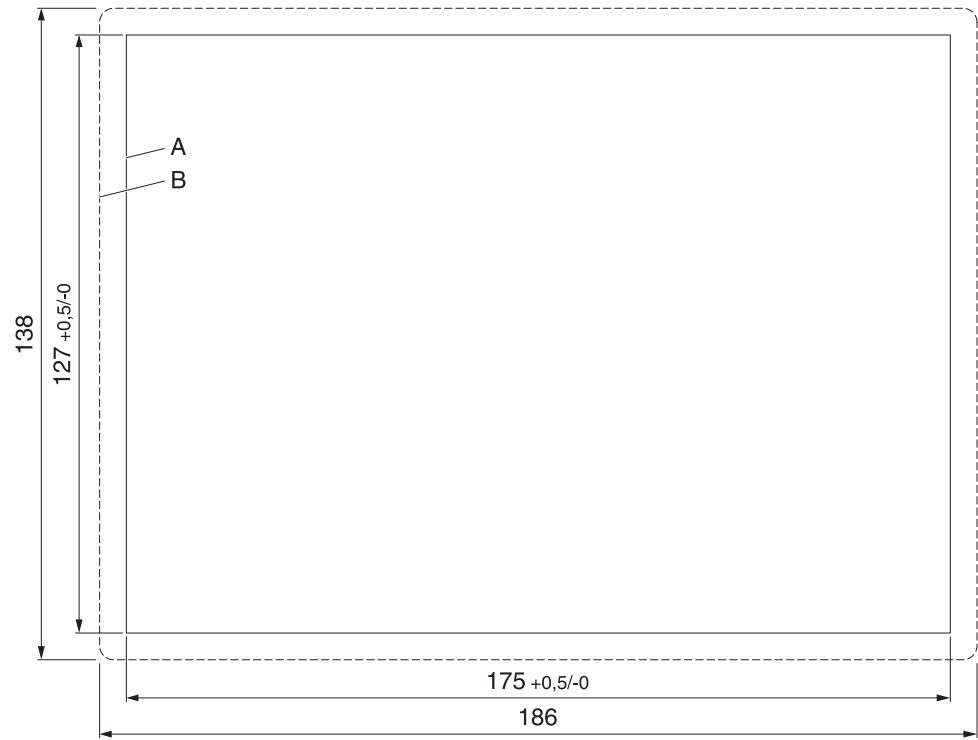

Figure 2-3 Mounting cutout (dimensions in mm)

- A Mounting Cutout
- B Front Panel

2.2.1.3 BWP 2102W

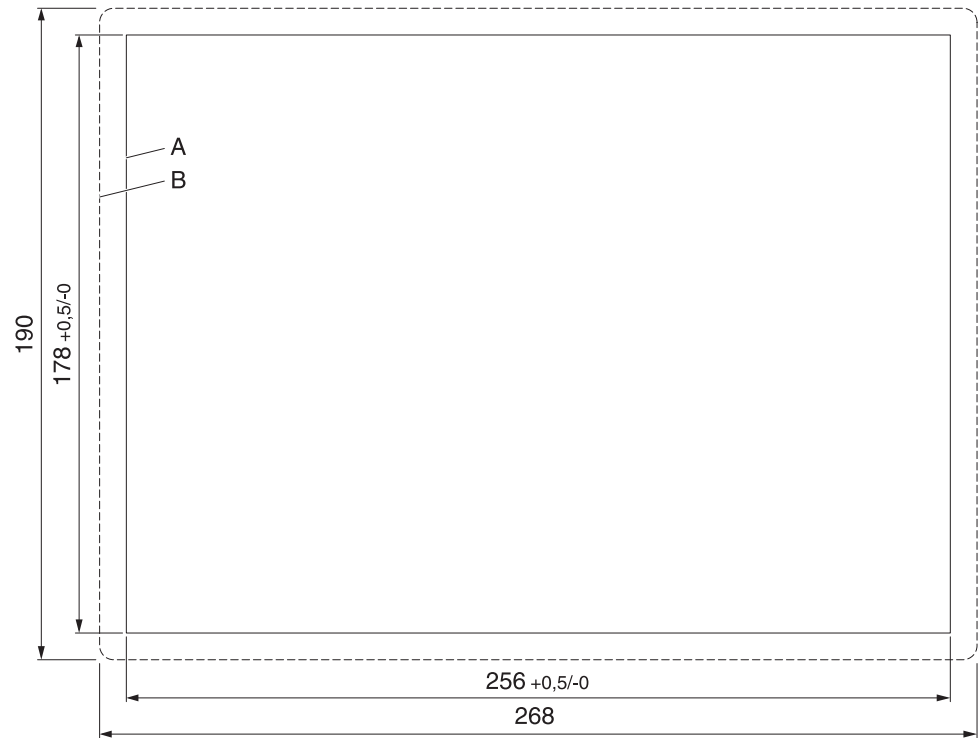

Figure 2-4 Mounting cutout (dimensions in mm)

- A** Mounting Cutout
- B** Front Panel

2.2.2 Side View, Mounting Depth

2.2.2.1 BWP 2043W

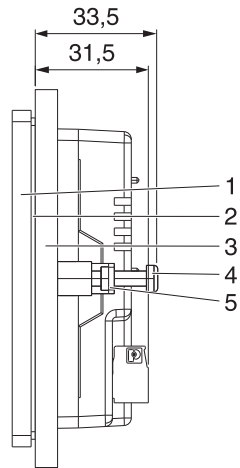

Figure 2-5 Mounting depth (dimensions in mm)

- 1 Front Panel
- 2 Circumferential Seal
- 3 Mounting Surface Thickness 1 mm to 6 mm
- 4 Screw
- 5 Mounting Bracket

2.2.2.2 BWP 2070W

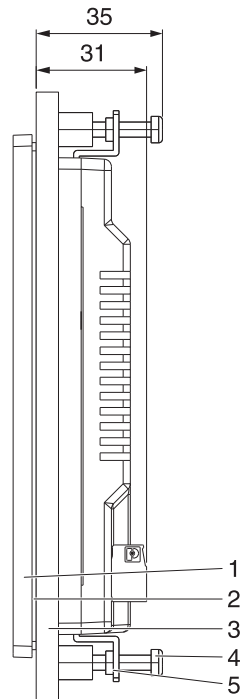

Figure 2-6 Mounting depth (dimensions in mm)

- 1 Front Panel
- 2 Circumferential Seal
- 3 Mounting Surface Thickness 1 mm to 6 mm
- 4 Screw
- 5 Mounting Bracket

2.2.2.3 BWP 2102W

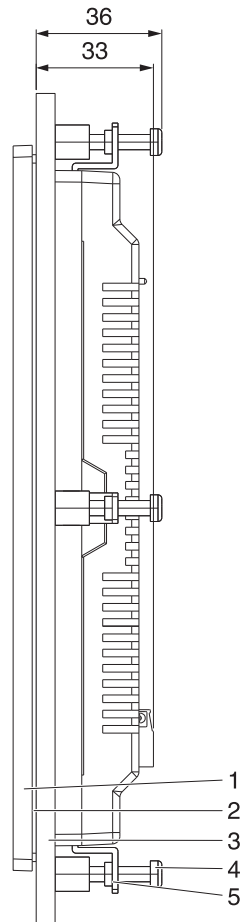

Figure 2-7 Mounting depth (dimensions in mm)

- 1 Front Panel
- 2 Circumferential Seal
- 3 Mounting Surface Thickness 1 mm to 6 mm
- 4 Screw
- 5 Mounting Bracket

2.3 Connecting the Device

2.3.1 Supply Voltage

The supply voltage is supplied via pin strip. A suitable socket strip is supplied.

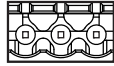

1

Figure 2-8 3 pin male connector

Refer to the technical data for the permissible supply voltage of the operating device.



The device has reverse polarity protection. In case of wrong polarity, the device will not operate.

Connector in the operating device: 3 pin male connector

Table 2-1 Pin assignment supply voltage

Pin	Function
24V	Supply voltage $\overline{\text{---}}$ 24 V
0V	Supply voltage 0 V
\oplus	Protective ground



DANGER: Hazardous voltages

Hazardous voltages can exist inside electrical installations that can pose a danger to humans. Coming in contact with live parts may result in electric shock!



NOTICE: Damage

Cables with finely stranded copper conductors with a minimum cross-section of 0.75 mm² (18 AWG) and a maximum cross-section of 2.5 mm² (14 AWG) must be used for the supply voltage.

You must adhere to the following torques at the connector:

Screw connection of terminal blocks: 0.5 Nm (minimal) to 0.6 Nm (maximum)

Use the following procedure to connect the device to the supply voltage:

1. Strip approx. 30 mm (1.181") off the outer cable sheath and approx. 5 mm (0.197") off the wires.

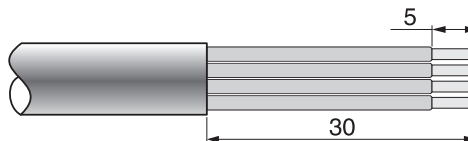

Figure 2-9 Preparing the cable

2. Fit the wires with wire end ferrules and connect the wires to the socket strip.
3. Plug the socket strip into the pin strip on the operating device.
4. Secure the socket strip against slipping out with screws.

2.4 Switching On

When switching on the operating system loads.



Please also pay attention to the further information in the user manual of your software option at phoenixcontact.net/products.

2.5 Identification

The operating device can be identified using the nameplate on the rear of the device.



Figure 2-10 Nameplate (example)

- 1 Article number, device type
- 2 MAC-Adress
- 3 Voltage and power specification

3 Control and Display Elements

3.1 Touchscreen

The device is equipped with a resistive 4 wire touch screen. You operate the device using this touch screen.

**NOTICE: Damage**

Pointed or sharp objects, such as pens or fingernails, can lead to irreparable damages of the touch screen. Exclusively therefore use the fingertips or the aids indicated in the technical data for the operation.

3.2 Display

**DANGER: Toxic**

If the display is damaged, avoid touching, swallowing or breathing in the liquids or gases which may leak out!

**DANGER: Corrosive**

If the display is damaged, avoid touching, swallowing or breathing in the liquids or gases which may leak out!



Pixel failures, which can occur with TFT displays, are due to production and no complaint reason!

The operating device is equipped with different displays (see technical data) depending on variant.

4 Interfaces of the Device

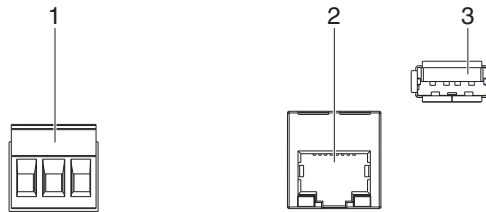

Figure 4-1 Interfaces of the device

- 1 Connector 24 V (Supply Voltage)
- 2 Connector ETHERNET (10/100 MBit)
- 3 Connector HOST (USB 2.0 - Type A)

4.1 USB (HOST)

A USB interface is available at the operating device to connect periphery equipment (for example: Mass memory, printer, scanner, mouse, keyboard etc.).



NOTICE:

Using hardware not suitable for industrial use (for example keyboard, mouse, memory card) in industrial environments may decrease safety of operation. This includes hardware intended for home and office use.

4.1.1 Cable



For the specification of a suitable cable, please refer to the „Universal Serial Bus Specification“.



NOTICE:

Use industrial-suited USB cables with a length of maximally 2.5 m (8.202 feet).

4.2 Ethernet

A 10/100 Base-T Ethernet interface is available at the operating device.

4.2.1 Pin Assignment

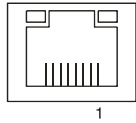

Figure 4-2 Ethernet connector

Connector in the operating device: RJ45 female connector.

Table 4-1 Assignment of the Ethernet interface

Pin	Designation	Function
1	Tx+	Transmitted Data, Positive Polarity
2	Tx-	Transmitted Data, Negative Polarity
3	Rx+	Received Data, Positive Polarity
4	n.c.	Not Connected
5	n.c.	Not Connected
6	Rx-	Received Data, Negative Polarity
7	n.c.	Not Connected
8	n.c.	Not Connected

4.2.2 Cable



NOTICE

Use a twisted pair cable of category 5 (CAT 5). The maximum cable length is 100 m (328.084 feet).



See the IEEE 802.3 standard for further information.

5 Maintenance and Servicing

5.1 Front Panel

Only use a damp cloth to remove any dirt from the front panel.

6 Technical Data

6.1 General

Touch Screen

Type Analog resistive, 4 wire technology

USB

Corresponds to the „Universal serial bus specification Rev. 2.0“

Host	Min.: 1,5 Mbit/s Max.: 12 Mbit/s
------	-------------------------------------

Ethernet

Ethernet 10/100 Mbit/s

Central Processing Unit

Central processing unit	Arm® Cortex®-A9
Clock frequency	1 GHz

Memory

RAM	1 GByte
Mass storage	4 GByte eMMC

Connection System

Male connector strip Phoenix COMBICON, 3 pin

RJ45 male connector

USB male connector type A

Environmental Conditions

Temperature during operation	0 °C to 50 °C (32 °F to 122 °F)
Temperature during storage, transport	- 20 °C to + 85 °C (- 4 °F to 185 °F)
Relative air humidity for operation and storage	10 % to 95 %, no condensation
Vibration resistance	5 to 150 Hz (X, Y, Z direction, 3G) according to IEC60068-2-6

Standards and Guidelines

Interference immunity	IEC 61000-4-2 IEC 61000-4-3 IEC 61000-4-4 IEC 61000-4-5 IEC 61000-4-6
Emitted interference	IEC 61000-6-4 EN 55011 limit value class A
Equipment requirements	DIN EN 61131-2
Storage and transportation	DIN EN 61131-2
Power supply	DIN EN 61131-2
Impact load, shocks	IEC 60068-2-27
Sinusoidal vibrations	IEC 60068-2-6



NOTICE: Radio Interference

Operation of this device may cause radio interference in residential areas.

Approvals

CE

6.2 BWP 2043W

Display

Size (diagonal) in cm (inch)	10.92 (4.3)
Type	TFT (color)
Resolution (pixels)	480 x 272
Colors	16.77 million
Viewing angle (left / right / up / down) in °	70 / 70 / 50 / 70
Half-life backlighting	20,000 h
Brightness in cd/m ²	400
Display area (H x W) in mm (Inch)	53.8 x 95 (2.118 x 3.74)

Electrical Data

Supply voltage	24 V DC (+/- 15%)
Power consumption (typical at 24 V)	0.22 A
Connected load	5.3 W

Front Panel and Enclosure

Enclosure	Plastic (black)
Front panel (H x W x D) in mm (Inch)	89 x 120 x 5 (3.5 x 4.724 x 0.196)
Seal	Circumferential rubber seal on the rear
Mounting cutout (H x W) in mm (Inch)	80 x 111 (3.149 x 4.37)
Mounting brackets	2
Mounting depth in mm (Inch)	About 31.5 (1.24)
Degree of protection	Front: IP66 Rear: IP20
Total weight	About 200 g

6.3 BWP 2070W

Display

Size (diagonal) in cm (inch)	17.78 (7)
Type	TFT (color)
Resolution (pixels)	800 x 480
Colors	16.77 million
Viewing angle (left / right / up / down) in °	70 / 70 / 50 / 70
Half-life backlighting	25,000 h
Brightness in cd/m ²	350
Display area (H x W) in mm (Inch)	154.08 x 85.92 (6.066 x 3.382)

Electrical Data

Supply voltage	24 V DC (+/- 15%)
Power consumption (typical at 24 V)	0.25 A
Connected load	6 W

Front Panel and Enclosure

Enclosure	Plastic (black)
Front panel (H x W x D) in mm (Inch)	138 x 186 x 5 (5.433 x 7.322 x 0.196)
Seal	Circumferential rubber seal on the rear
Mounting cutout (H x W) in mm (Inch)	127 x 175 (5 x 6.889)
Mounting brackets	4
Mounting depth in mm (Inch)	About 31 (1.22)
Degree of protection	Front: IP66 Rear: IP20
Total weight	About 400 g

6.4 BWP 2102W

Display

Size (diagonal) in cm (inch)	25.9 (10.2)
Type	TFT (color)
Resolution (pixels)	1024 x 600
Colors	16.77 million
Viewing angle (left / right / up / down) in °	65 / 65 / 45 / 65
Half-life backlighting	25,000 h
Brightness in cd/m ²	350
Display area (H x W) in mm (Inch)	222.72 x 125.28 (8.768 x 4.932)

Electrical Data

Supply voltage	24 V DC (+/- 15%)
Power consumption (typical at 24 V)	0.35 A
Connected load	8.4 W

Front Panel and Enclosure

Enclosure	Plastic (black)
Front panel (H x W x D) in mm (Inch)	190 x 268 x 5 (7.48 x 10.551 x 0.196)
Seal	Circumferential rubber seal on the rear
Mounting cutout (H x W) in mm (Inch)	178 x 256 (7 x 10.078)
Mounting brackets	6
Mounting depth in mm (Inch)	About 33 (1.299)
Degree of protection	Front: IP66 Rear: IP20
Total weight	About 900 g

A 1 Index

C

Cable	
Ethernet.....	24
USB.....	23
Connecting.....	19

D

Dimensions	
Cutout.....	13
Display.....	21

I

Identification.....	20
Intended use.....	8
Interface	
Ethernet.....	24
USB.....	23

M

Maintenance.....	25
Mounting.....	11
Mounting cutout	
BWP 2043W.....	13
BWP 2070W.....	14
BWP 2102W.....	15
Mounting depth	
BWP 2043W.....	16
BWP 2070W.....	17
BWP 2102W.....	18

N

Nameplate.....	20
----------------	----

P

Pin assignment	
Ethernet.....	24

S

Safety notes.....	7
Servicing.....	25

Side view

BWP 2043W.....	16
BWP 2070W.....	17
BWP 2102W.....	18
Standards.....	28
Supply Voltage.....	19
Switching on.....	20
Symbols.....	7

T

Target group.....	9
Technical data.....	27
BWP 2043W.....	29
BWP 2070W.....	30
BWP 2102W.....	31
Touchscreen.....	21

U

Unpacking.....	11
----------------	----

单击下面可查看定价，库存，交付和生命周期等信息

[>>Phoenix Contact\(菲尼克斯\)](#)