

## Bus system cable - SAC-4P-MINMR/20,0-960/MINFRVA - 1429978

Please be informed that the data shown in this PDF Document is generated from our Online Catalog. Please find the complete data in the user's documentation. Our General Terms of Use for Downloads are valid (<http://download.phoenixcontact.com>)



Bus system cable, FOUNDATION Fieldbus, Foundation Fieldbus, 3-position, PVC, orange RAL 2003, shielded, Plug angled 7/8"-16UNF, A-coded, on Socket angled 7/8"-16UNF, A-coded, Cable length: 20 m



### Key commercial data

Packing unit	1 1
Weight per Piece (excluding packing)	222.22 GRM
Custom tariff number	85444290
Country of origin	Germany

### Technical data

#### Dimensions

Length of cable	20 m
-----------------	------

#### Ambient conditions

Ambient temperature (operation)	-40 °C ... 105 °C (Plug / socket)
Degree of protection	IP67

#### General

Rated current at 40°C	5.2 A
Rated voltage	300 V
Number of positions	3
Contact resistance	≤ 5 mΩ
Insulation resistance	≥ 10 MΩ
Coding	A - standard
Signal type/category	FOUNDATION Fieldbus
Status display	No

## Bus system cable - SAC-4P-MINMR/20,0-960/MINFRVA - 1429978

### Technical data

#### General

Surge voltage category	II
Pollution degree	2
Torque	0.8 Nm (7/8" connectors)

#### Material

Inflammability class according to UL 94	HB
Contact material	CuZn
Contact surface material	AU
Contact carrier material	PA 66
Material of grip body	TPU
Material, knurls	High-grade steel

#### Cable

Cable type	FOUNDATION Fieldbus orange
Cable type (abbreviation)	960
Cable structure	2xAWG18/7 + 1xAWG20/7
Conductor cross section	2x 0.75 mm <sup>2</sup> (signal line)
	1x 0.5 mm <sup>2</sup> (Drain wire)
AWG signal line	18
Conductor structure signal line	7x 0.40 mm
Core diameter including insulation	2.24 mm ±0.05 mm
Thickness, insulation	0.5 mm (Core insulation)
	1 mm (Outer cable sheath)
Wire colors	Blue, orange
Twisted pairs	2 cores to the pair
Overall twist	One pair with one drain wire and fillers for core
Shielding	Plastic-coated aluminum foil with a drain wire
Optical shield covering	100 %
External sheath, color	orange RAL 2003
External cable diameter	7.42 mm
External cable diameter D	7.5 mm ±0.25 mm
Smallest bending radius, fixed installation	75 mm
Cable weight	56.552 kg/km
Outer sheath, material	PVC
Material conductor insulation	PO (signal line)
Conductor material	Tin-plated Cu litz wires
Conductor resistance	19.2 Ω/km (signal line)
	26 Ω/km (shield)

## Bus system cable - SAC-4P-MINMR/20,0-960/MINFRVA - 1429978

### Technical data

#### Cable

Working capacitance	148 nF (core-shield)
	78 nF (core-core)
Wave impedance	100 Ω (At 31.25 kHz)
Signal speed	0.66 c
Nominal voltage, cable	300 V
Special properties	UL standards PLTC-ER and ITC
Flame resistance	UL 1685 (CSA FT 4)
Ambient temperature (operation)	-30 °C ... 105 °C (Cable)

### Classifications

#### eCl@ss

eCl@ss 4.0	27060306
eCl@ss 4.1	27060306
eCl@ss 5.0	27061801
eCl@ss 5.1	27061801
eCl@ss 6.0	27061801
eCl@ss 7.0	27061801
eCl@ss 8.0	27061801

#### ETIM

ETIM 3.0	EC001855
ETIM 4.0	EC001855
ETIM 5.0	EC001855

#### UNSPSC

UNSPSC 6.01	31251501
UNSPSC 7.0901	31251501
UNSPSC 11	31251501
UNSPSC 12.01	31251501
UNSPSC 13.2	31251501

### Approvals

#### Approvals

#### Approvals

UL Listed / cUL Listed / GOST / cULus Listed

# Bus system cable - SAC-4P-MINMR/20,0-960/MINFRVA - 1429978

## Approvals

Ex Approvals

Approvals submitted

## Approval details

UL Listed	
Nominal current IN	5.2 A
Nominal voltage UN	300 V

cUL Listed	
Nominal current IN	5.2 A
Nominal voltage UN	300 V

GOST	
------	--

cULus Listed	
--------------	--

## Drawings

Schematic diagram

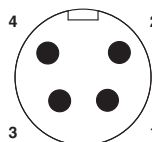

Pin assignment, plug, 7/8"-16UNF, 4-pos., view of male side

Schematic diagram

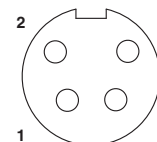

Pin assignment, socket, 7/8"-16UNF, 4-pos., view of female side

# Bus system cable - SAC-4P-MINMR/20,0-960/MINFRVA - 1429978

Cable cross section



FOUNDATION Fieldbus orange [960]

Dimensioned drawing

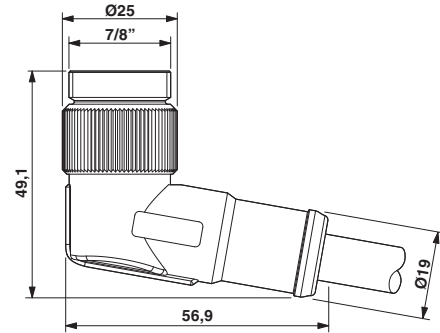

7/8"-16UNF plug, angled

Dimensioned drawing

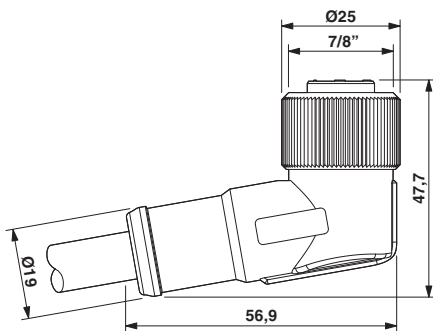

7/8"-16UNF socket, angled

Circuit diagram

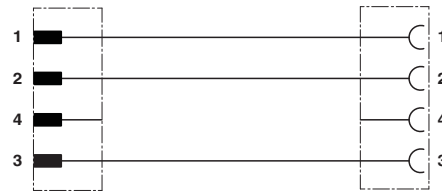

Contact assignment of the 7/8" connector and the 7/8" socket

单击下面可查看定价，库存，交付和生命周期等信息

[>>Phoenix Contact\(菲尼克斯\)](#)