

Power supply unit - TRIO-PS67/1AC/24DC/8/INC - 1065976

Please be informed that the data shown in this PDF Document is generated from our Online Catalog. Please find the complete data in the user's documentation. Our General Terms of Use for Downloads are valid (<http://phoenixcontact.com/download>)



TRIO POWER primary-switched power supply in IP67 die-cast housing, 7/8" circular connector, input: 1-phase, output: 24 V DC/8 A



Key Commercial Data

Packing unit	1 pc
GTIN	 4 055626 731032
GTIN	4055626731032
Weight per Piece (excluding packing)	1,700.000 g
Custom tariff number	85044082
Country of origin	China

Technical data

Dimensions

Width	136 mm
Height	240 mm
Depth	53 mm

Ambient conditions

Degree of protection	IP67
Inflammability class in acc. with UL 94 (housing / terminal blocks)	V0
Ambient temperature (operation)	-25 °C ... 70 °C (Derating >60°C: 2.5 %/K)
Ambient temperature (start-up type tested)	-25 °C
Ambient temperature (storage/transport)	-40 °C ... 85 °C
Max. permissible relative humidity (operation)	≤ 100 % (at 25 °C, non-condensing)

Power supply unit - TRIO-PS67/1AC/24DC/8/INC - 1065976

Technical data

Ambient conditions

Permissible humidity (operation)	≤ 100 % (at 25 °C, non-condensing)
Climatic class	3K3 (in acc. with EN 60721)
Degree of pollution	3
Installation height	≤ 4000 m (> 2000 m, Derating: 10 %/1000 m)

Input data

Nominal input voltage range	100 V AC ... 240 V AC
	110 V DC ... 250 V DC
Input voltage range	100 V AC ... 240 V AC #10 %
	110 V DC ... 250 V DC ±10 %
Dielectric strength maximum	≤ 300 V AC 15 s
AC frequency range	50 Hz ... 60 Hz ±10 %
Frequency range (f _N)	50 Hz ... 60 Hz ±10 %
Discharge current to PE	< 3.5 mA
Current consumption	2.2 A (100 V AC)
	0.9 A (240 V AC)
Nominal power consumption	285 VA
Inrush current	≤ 25 A (typical)
Mains buffering time	> 15 ms (120 V AC)
	> 15 ms (230 V AC)
Input fuse	6.3 A (internal (device protection))
Recommended breaker for input protection	6 A ... 16 A (US/CAN: branch circuit protection < 20 A) (Characteristic B, C, D, K or comparable)
Power factor (cos phi)	> 0.93
Type of protection	Transient surge protection
Protective circuit/component	Varistor

Output data

Nominal output voltage	24 V DC ±1 %
Nominal output current (I _N)	8 A
Dynamic Boost (I _{Dyn.Boost})	12 A (5 s)
Derating	> 60 °C ... 70 °C (2.5%/K)
Connection in parallel	no
Connection in series	No
Feedback voltage resistance	≤ 35 V DC
Protection against overvoltage at the output (OVP)	≤ 30 V DC
Control deviation	< 1 % (change in load, static 10 % ... 90 %)
	< 3 % (Dynamic load change 10 % ... 90 %, 10 Hz)

Power supply unit - TRIO-PS67/1AC/24DC/8/INC - 1065976

Technical data

Output data

	< 0.1 % (change in input voltage ± 10 %)
Residual ripple	≤ 10 mV _{PP}
Output power	192 W
Maximum power dissipation in no-load condition	< 8 W (120 V AC)
	< 5 W (230 V AC)
Power loss nominal load max.	< 18 W (120 V AC)
	< 14 W (230 V AC)

General

Net weight	1.5 kg
Efficiency	typ. 91 % (120 V AC)
	typ. 93 % (230 V AC)
MTBF (IEC 61709, SN 29500)	> 1800000 h (25 °C)
	> 1000000 h (40 °C)
	> 480000 h (60 °C)
Insulation voltage input/output	3 kV AC (type test)
	1.5 kV AC (routine test)
Degree of protection	IP67
Protection class	I
Inflammability class in acc. with UL 94 (housing / terminal blocks)	V0
Assembly instructions	Alignable: 20 mm horizontally, 50 mm vertically above, 100 mm vertically below

Connection data, input

Connection method	7/8" circular connector
Type of locking	Screw locking
Range of positions	3 Plug

Connection data, output

Connection method	7/8" circular connector
Type of locking	screw locking
Range of positions	4 Socket

Standards

Standard designation	Electrical safety
Standards/regulations	IEC 61010-1 (SELV)
Standard designation	Protective extra-low voltage
Standards/regulations	IEC 61010-1 (SELV)
	IEC 61010-2-201 (PELV)
Standard designation	Safe isolation

Power supply unit - TRIO-PS67/1AC/24DC/8/INC - 1065976

Technical data

Standards

Standards/regulations	IEC 61558-2-16
Standard designation	Low-voltage power supplies, DC output
Standards/regulations	EN 61204-3
Standard designation	Safety requirements for electrical equipment for measurement, control, and laboratory use
Standards/regulations	IEC 61010-1
Standard designation	Limit values for harmonic currents
Standards/regulations	EN 61000-3-2
Standard designation	Degrees of protection provided by enclosures (IP code)
Standards/regulations	EN/IEC 60529
Overvoltage category EN 61010-1	III (≤ 2000 m)
	II (≤ 4000 m)

EMC data

Electromagnetic compatibility	Conformance with EMC Directive 2014/30/EU
Low Voltage Directive	Conformance with Low Voltage Directive 2014/35/EC
Conducted noise emission	EN 55016
	EN 61000-6-3 (Class B)
Noise emission	EN 55016
	EN 61000-6-3 (Class B)
Harmonic currents	EN 61000-3-2
	EN 61000-3-2 (Class A)
Electrostatic discharge	EN 61000-4-2
Contact discharge	6 kV (Test Level 3)
Electromagnetic HF field	EN 61000-4-3
Frequency range	80 MHz ... 1 GHz
Test field strength	10 V/m (Test Level 3)
Frequency range	1 GHz ... 2 GHz
Test field strength	10 V/m (Test Level 3)
Frequency range	2 GHz ... 6 GHz
Test field strength	10 V/m (Test Level 3)
Comments	Criterion A
Fast transients (burst)	EN 61000-4-4
Input	4 kV (Test Level 3 - asymmetrical)
Output	2 kV (Test Level 3 - asymmetrical)
Signal	2 kV (Test Level 3 - asymmetrical)
Comments	Criterion A
Surge voltage load (surge)	EN 61000-4-5

Power supply unit - TRIO-PS67/1AC/24DC/8/INC - 1065976

Technical data

EMC data

Input	2 kV (Test Level 4 - symmetrical)
	4 kV (Test Level 4 - asymmetrical)
Output	1 kV (Test Level 3 - symmetrical)
	2 kV (Test Level 3 - asymmetrical)
Signal	1 kV (Test Level 2 - asymmetrical)
Comments	Criterion A
Conducted interference	EN 61000-4-6
Frequency range	0.15 MHz ... 80 MHz
Voltage	10 V (Test Level 3)
Comments	Criterion A
Voltage dips	EN 61000-4-11
Voltage	230 V AC
Frequency	50 Hz
Voltage dip	70 %
Number of periods	25 periods
Comments	Criterion A
Voltage dip	40 %
Number of periods	10 periods
Comments	Criterion A
Voltage dip	0 %
Number of periods	1 period
Comments	Criterion A
Criterion A	Normal operating behavior within the specified limits.
Criterion B	Temporary impairment to operational behavior that is corrected by the device itself.
Criterion C	Temporary adverse effects on the operating behavior, which the device corrects automatically or which can be restored by actuating the operating elements.

Environmental Product Compliance

REACH SVHC	Lead 7439-92-1
------------	----------------

Drawings

Power supply unit - TRIO-PS67/1AC/24DC/8/INC - 1065976

Block diagram

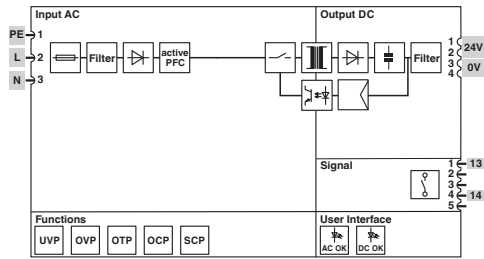

Diagram

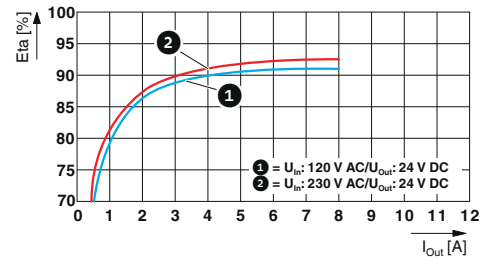

Diagram

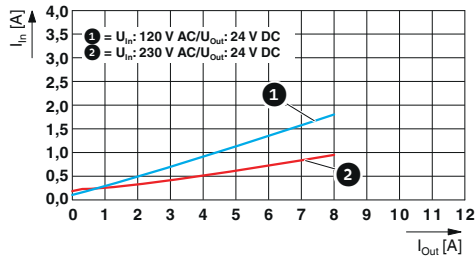

Diagram

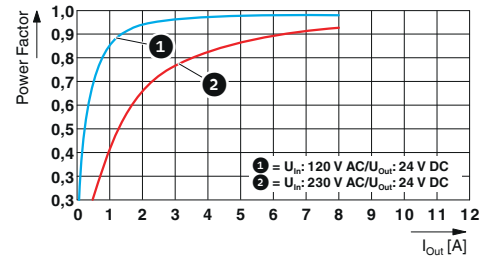

Diagram

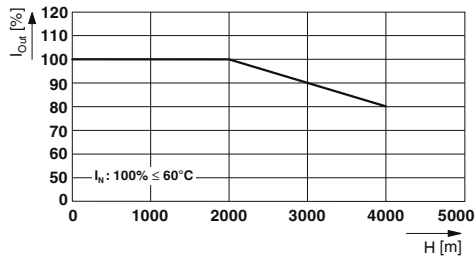

Diagram

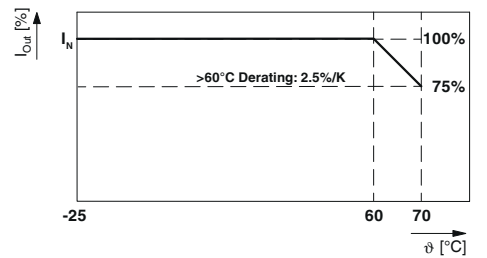

Power supply unit - TRIO-PS67/1AC/24DC/8/INC - 1065976

Dimensional drawing

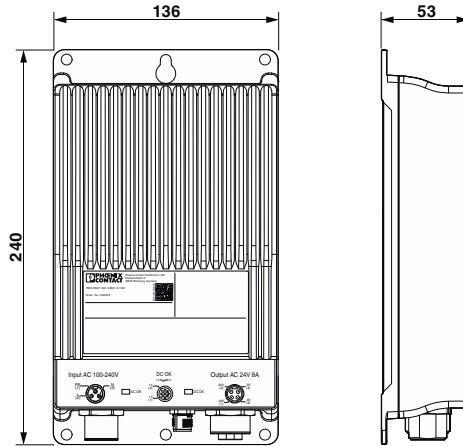

Classifications

eCl@ss

eCl@ss 11.0	27040701
eCl@ss 9.0	27040701

ETIM

ETIM 7.0	EC002540
----------	----------

Approvals

Approvals

Approvals

cULus Listed / IECCEB CB Scheme

Ex Approvals

Approval details

cULus Listed		http://database.ul.com/cgi-bin/XYV/template/LISEXT/1FRAME/index.htm	FILE E 123528
--------------	--	---	---------------

Power supply unit - TRIO-PS67/1AC/24DC/8/INC - 1065976

Approvals

IECEE CB Scheme



<http://www.iecee.org/>

DK-113104-UL

Accessories

Accessories

Circular connector (cable-side)

Connector - SACC-MINFS-3CON-PG 9 - 1521300



Connector, Universal, 3-position, Socket straight 7/8"-UNF, Coding: A, Screw connection, knurl material: Zinc die-cast, nickel-plated, cable gland Pg9, external cable diameter 6 mm ... 8 mm

Connector - SACC-MINFS-3CON-PG13 - 1521313



Connector, Universal, 3-position, Socket straight 7/8"-UNF, Coding: A, Screw connection, knurl material: Zinc die-cast, nickel-plated, cable gland Pg13,5, external cable diameter 10 mm ... 12 mm

Connector - SACC-MINMS-4CON-PG 9 - 1521326



Connector, Universal, 4-position, Plug straight 7/8"-UNF, Coding: A, Screw connection, knurl material: Zinc die-cast, nickel-plated, cable gland Pg9, external cable diameter 6 mm ... 8 mm, Contact 4 leading

Connector - SACC-MINMS-4CON-PG13 - 1521339



Connector, Universal, 4-position, Plug straight 7/8"-UNF, Coding: A, Screw connection, knurl material: Zinc die-cast, nickel-plated, cable gland Pg13,5, external cable diameter 10 mm ... 12 mm, Contact 4 leading

Power supply unit - TRIO-PS67/1AC/24DC/8/INC - 1065976

Accessories

Connector - SACC-M12FS-5PL M - 1424652



Connector, Universal, 5-position, unshielded, Socket straight M12, Coding: A, Push-lock spring connection, knurl material: Zinc die-cast, nickel-plated, external cable diameter 4 mm ... 8 mm

Sensor/actuator cable

Sensor/actuator cable - SAC-5P- 1,5-PUR/M12FS - 1669822



Sensor/actuator cable, 5-position, PUR halogen-free, black-gray RAL 7021, free cable end, on Socket straight M12, coding: A, cable length: 1.5 m

单击下面可查看定价，库存，交付和生命周期等信息

[>>Phoenix Contact \(菲尼克斯\)](#)