

PTSM 0,5/ 4-P-2,5 WH - PCB connector



1704857

<https://www.phoenixcontact.com/pc/products/1704857>

Please be informed that the data shown in this PDF document is generated from our online catalog. Please find the complete data in the user documentation. Our general terms of use for downloads are valid.

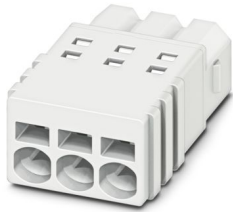

PCB connector, nominal cross section: 0.5 mm², color: white, nominal current: 6 A, rated voltage (III/2): 160 V, contact surface: Tin, contact connection type: Socket, number of potentials: 4, number of rows: 1, number of positions: 4, number of connections: 4, product range: PTSM 0,5/..-P WH, pitch: 2.5 mm, connection method: Push-in spring connection, conductor/PCB connection direction: 0 °, plug-in system: COMBICON PTSM, locking: without, mounting: without, type of packaging: packed in cardboard

Your advantages

- White design: Stable color when welding and during use
- Time saving push-in connection, tools not required
- Defined contact force ensures that contact remains stable over the long term
- High current carrying capacity of 6 A in very compact dimensions

Commercial data

Item number	1704857
Packing unit	250 pc
Minimum order quantity	250 pc
Product key	AAAFPA
Catalog page	Page 395 (C-1-2013)
GTIN	4046356740821
Weight per piece (including packing)	1.122 g
Weight per piece (excluding packing)	1.096 g
Customs tariff number	85366990
Country of origin	IN

PTSM 0,5/ 4-P-2,5 WH - PCB connector



1704857

<https://www.phoenixcontact.com/pc/products/1704857>

Technical data

Product properties

Product type	PCB connector
Product family	PTSM 0,5/...-P WH
Product line	COMBICON Connectors XS
Type	Standard
Number of positions	4
Pitch	2.5 mm
Number of connections	4
Number of rows	1
Number of potentials	4
Mounting flange	without

Electrical properties

Nominal current I_N	6 A
Nominal voltage U_N	160 V
Contact resistance	2.4 mΩ
Rated voltage (III/3)	100 V
Rated surge voltage (III/3)	2.5 kV
Rated voltage (III/2)	160 V
Rated surge voltage (III/2)	2.5 kV
Rated voltage (II/2)	320 V
Rated surge voltage (II/2)	2.5 kV

Connection data

Connection technology

Type	Standard
Connector system	COMBICON PTSM
Nominal cross section	0.5 mm ²
Contact connection type	Socket

Interlock

Locking type	without
Mounting flange	without

Conductor connection

Connection method	Push-in spring connection
Conductor/PCB connection direction	0 °
Conductor cross section rigid	0.14 mm ² ... 0.5 mm ²
Conductor cross section flexible	0.2 mm ² ... 0.5 mm ² (up to 0.75 mm ² supported, with a stripping length of 7.5 mm and a rated insulation voltage of 32 V at III/2)
Conductor cross section AWG	24 ... 20
Conductor cross section flexible, with ferrule without plastic	0.25 mm ² ... 0.5 mm ²

PTSM 0,5/ 4-P-2,5 WH - PCB connector



1704857

<https://www.phoenixcontact.com/pc/products/1704857>

sleeve	
Conductor cross section, flexible, with ferrule, with plastic sleeve	0.25 mm ² ... 0.34 mm ² (possible from 0.14 mm ² , when using ferrule AI 0.14- 6 GY in combination with crimping pliers CRIMPFOX 10T-F)
Cylindrical gauge a x b / diameter	- / 1.2 mm
Stripping length	6 mm

Material specifications

Material data - contact

Note	WEEE/RoHS-compliant, free of whiskers according to IEC 60068-2-82/JEDEC JESD 201
Contact material	Cu alloy
Surface characteristics	hot-dip tin-plated
Metal surface terminal point (top layer)	Tin (4 - 8 µm Sn)
Metal surface contact area (top layer)	Tin (4 - 8 µm Sn)

Material data - housing

Color (Housing)	white (9010)
Insulating material	PA
Insulating material group	I
CTI according to IEC 60112	600
Flammability rating according to UL 94	V0
Glow wire flammability index GWFI according to EN 60695-2-12	850
Glow wire ignition temperature GWIT according to EN 60695-2-13	775
Temperature for the ball pressure test according to EN 60695-10-2	125 °C

Dimensions

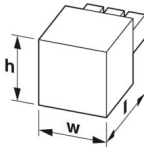
Dimensional drawing	
Pitch	2.5 mm
Width [w]	11.1 mm
Height [h]	5 mm
Length [l]	15 mm

Mechanical tests

Conductor connection

Specification	IEC 60999-1:1999-11
Result	Test passed

Test for conductor damage and slackening

PTSM 0,5/ 4-P-2,5 WH - PCB connector



1704857

<https://www.phoenixcontact.com/pc/products/1704857>

Specification	IEC 60999-1:1999-11
Result	Test passed

Repeated connection and disconnection

Specification	IEC 60999-1:1999-11
Result	Test passed

Pull-out test

Specification	IEC 60999-1:1999-11
Conductor cross section/conductor type/tractive force setpoint/actual value	0.14 mm ² / solid / > 10 N
	0.2 mm ² / flexible / > 10 N
	0.5 mm ² / solid / > 20 N
	0.75 mm ² / flexible / > 30 N

Insertion and withdrawal forces

Result	Test passed
No. of cycles	10
Insertion strength per pos. approx.	5 N
Withdraw strength per pos. approx.	3 N

Resistance of inscriptions

Specification	IEC 60068-2-70:1995-12
Result	Test passed

Polarization and coding

Specification	IEC 60512-13-5:2006-02
Result	Test passed

Visual inspection

Specification	IEC 60512-1-1:2002-02
Result	Test passed

Dimension check

Specification	IEC 60512-1-2:2002-02
Result	Test passed

Environmental and real-life conditions

Vibration test

Specification	IEC 60068-2-6:2007-12
Frequency	10 - 150 - 10 Hz
Sweep speed	1 octave/min
Amplitude	0.35 mm (10 Hz ... 60.1 Hz)
Acceleration	5g (60.1 Hz ... 150 Hz)
Test duration per axis	2.5 h

Durability test

Specification	IEC 60512-9-1:2010-03
---------------	-----------------------

PTSM 0,5/ 4-P-2,5 WH - PCB connector



1704857

<https://www.phoenixcontact.com/pc/products/1704857>

Impulse withstand voltage at sea level	2.95 kV
Contact resistance R ₁	2.4 mΩ
Contact resistance R ₂	2.3 mΩ
Insertion/withdrawal cycles	10
Insulation resistance, neighboring positions	> 5 MΩ

Climatic test

Specification	ISO 6988:1985-02
Corrosive stress	0.2 dm ³ SO ₂ on 300 dm ³ /40 °C/1 cycle
Thermal stress	100 °C/168 h
Power-frequency withstand voltage	1.39 kV

Ambient conditions

Ambient temperature (operation)	-40 °C ... 100 °C (dependent on the derating curve)
Ambient temperature (storage/transport)	-40 °C ... 70 °C
Relative humidity (storage/transport)	30 % ... 70 %
Ambient temperature (assembly)	-5 °C ... 100 °C

Electrical tests

Thermal test | Test group C

Specification	IEC 60512-5-1:2002-02
Tested number of positions	8

Insulation resistance

Specification	IEC 60512-3-1:2002-02
Insulation resistance, neighboring positions	> 5 MΩ

Temperature cycles

Specification	IEC 60999-1:1999-11
Result	Test passed

Air clearances and creepage distances |

Specification	IEC 60664-1:2007-04
Insulating material group	I
Comparative tracking index (IEC 60112)	CTI 600
Rated insulation voltage (III/3)	100 V
Rated surge voltage (III/3)	2.5 kV
minimum clearance value - non-homogenous field (III/3)	1.5 mm
minimum creepage distance (III/3)	1.8 mm
Rated insulation voltage (III/2)	160 V
Rated surge voltage (III/2)	2.5 kV
minimum clearance value - non-homogenous field (III/2)	1.5 mm
minimum creepage distance (III/2)	1.5 mm
Rated insulation voltage (II/2)	320 V
Rated surge voltage (II/2)	2.5 kV
minimum clearance value - non-homogenous field (II/2)	1.5 mm

PTSM 0,5/ 4-P-2,5 WH - PCB connector



1704857

<https://www.phoenixcontact.com/pc/products/1704857>

minimum creepage distance (II/2)	1.6 mm
----------------------------------	--------

Packaging specifications

Type of packaging	packed in cardboard
-------------------	---------------------

Drawings

Diagram

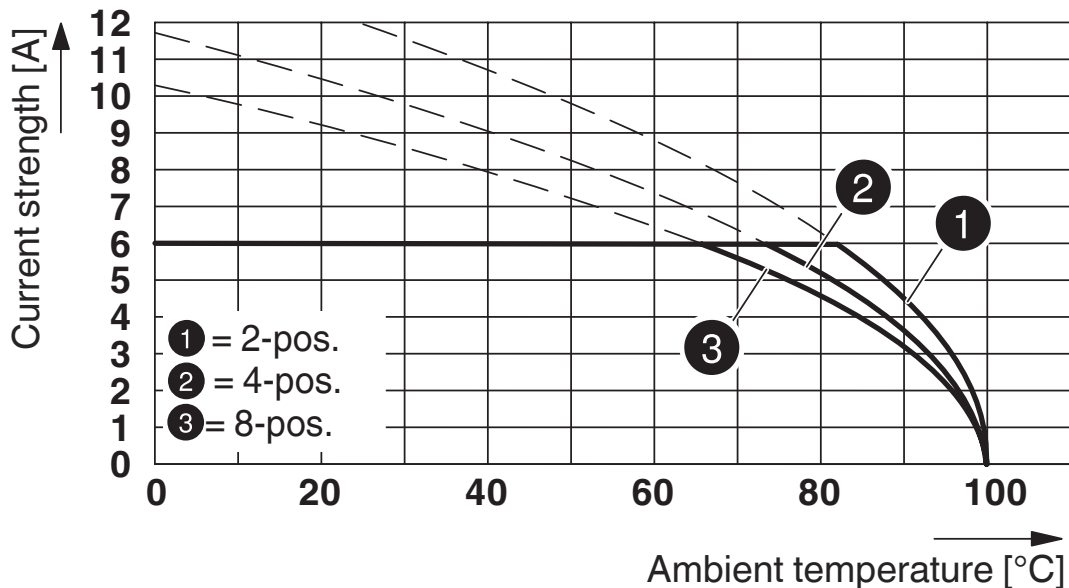

Type: PTSM 0,5/...-P-2,5 WH... with PTSM 0,5/...-HV-2,5-THR WH R...

Diagram

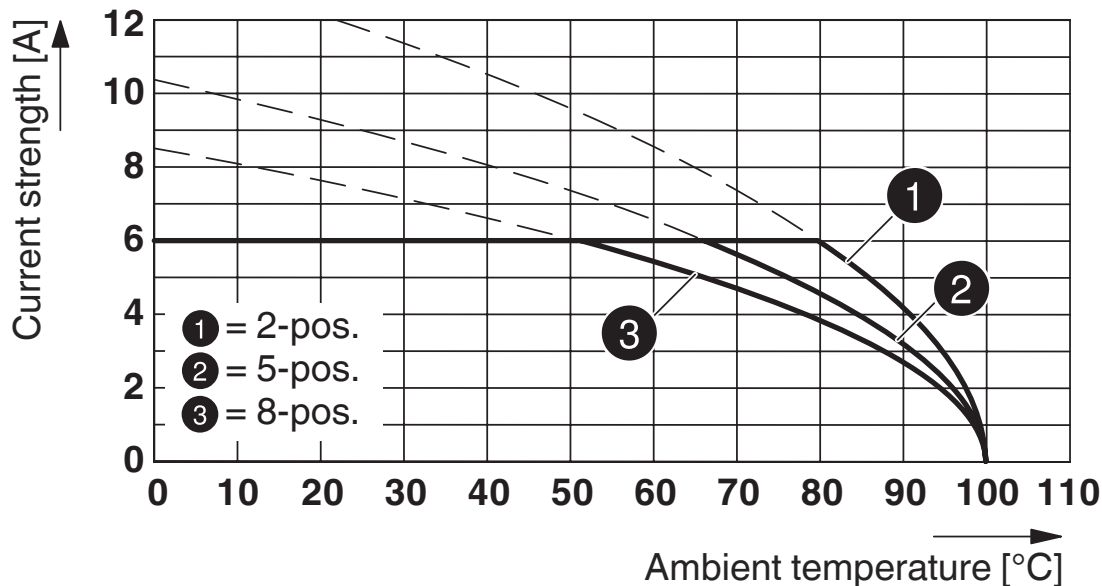

Type: PTSM 0,5/...-P-2,5 WH... with PTSM 0,5/...-HV-2,5-SMD WH R...

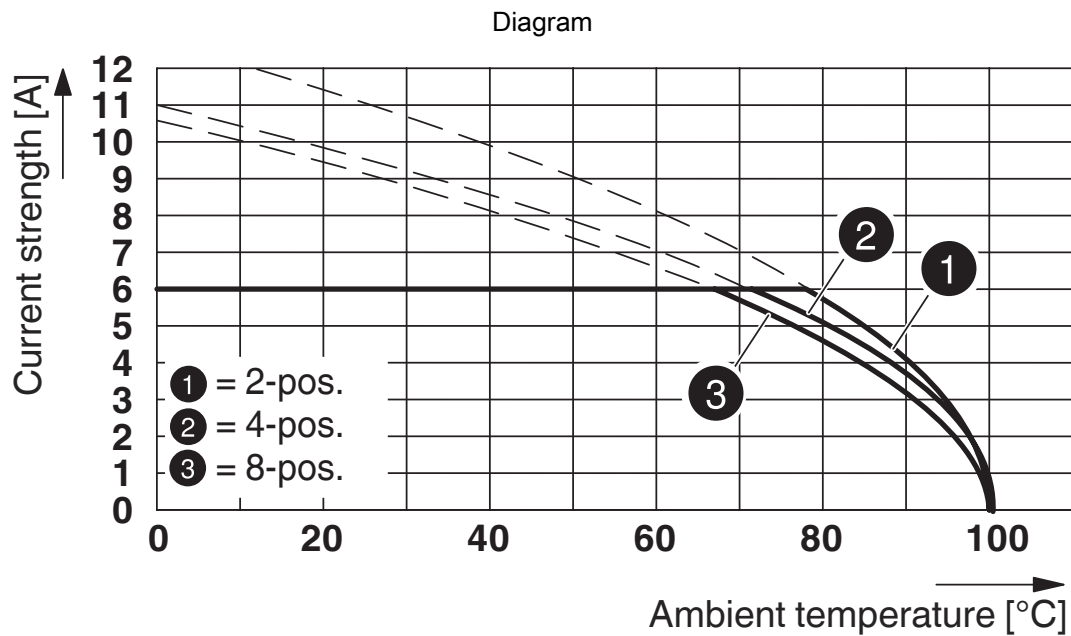

Type: PTSM 0,5/...-P-2,5 WH... with PTSM 0,5/...-HH-2,5-THR WH R...

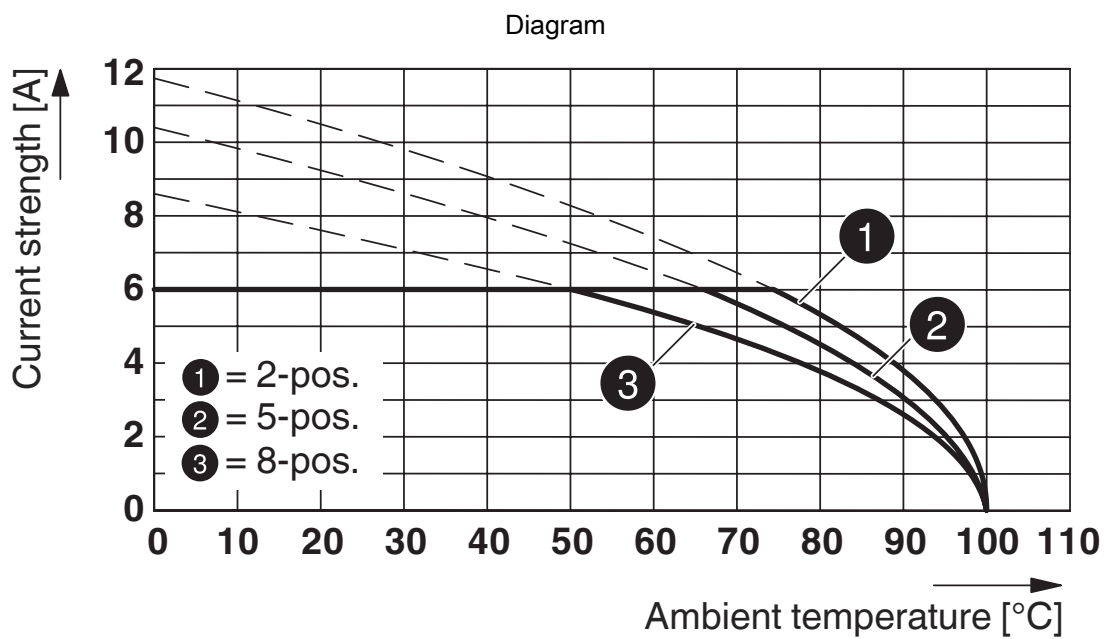

Type: PTSM 0,5/...-P-2,5 WH with PTSM 0,5/...-HTB-2,5-SMD WH R...

PTSM 0,5/ 4-P-2,5 WH - PCB connector

1704857

<https://www.phoenixcontact.com/pc/products/1704857>

Dimensional drawing

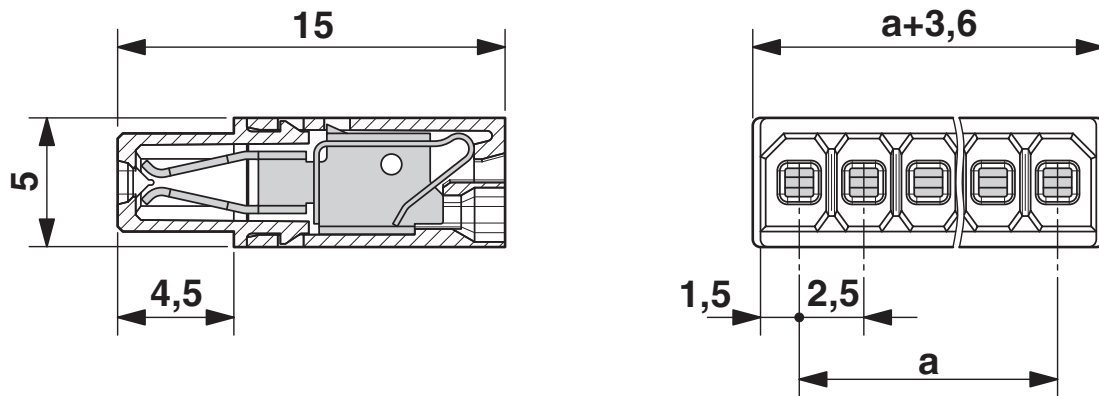

Diagram

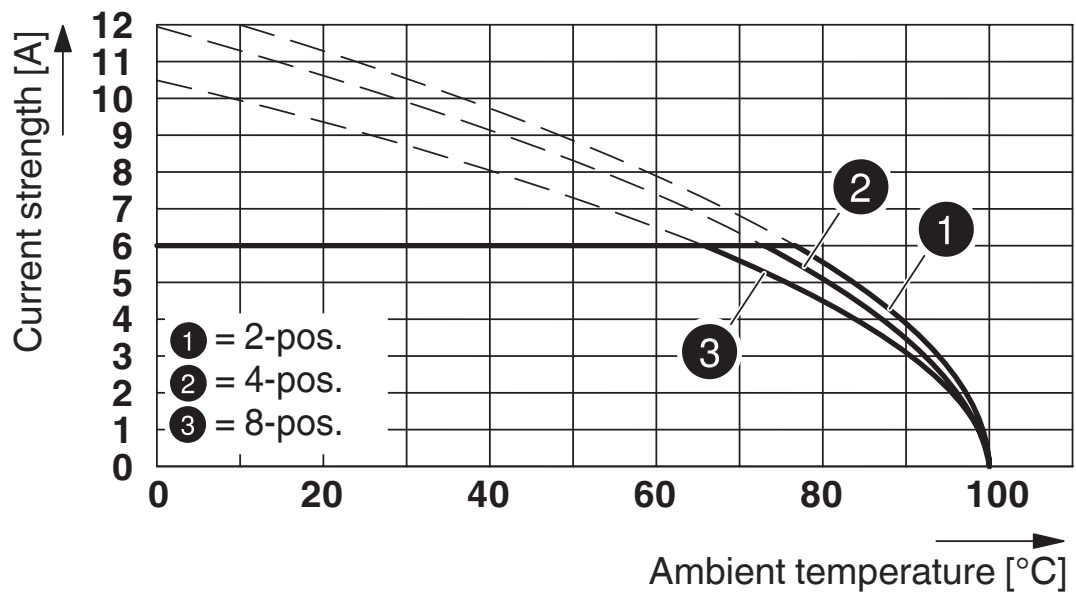

Type: PTSM 0,5/...-P-2,5 WH... with PTSM 0,5/...-HH0-2,5-SMD WH R...

PTSM 0,5/ 4-P-2,5 WH - PCB connector





1704857

<https://www.phoenixcontact.com/pc/products/1704857>

Approvals

To download certificates, visit the product detail page: <https://www.phoenixcontact.com/pc/products/1704857>

 UL Recognized Approval ID: E118976-20130619				
	Nominal voltage U_N	Nominal current I_N	Cross section AWG	Cross section mm^2
Use group B				
	150 V	5 A	26 - 18	-

 cULus Recognized Approval ID: E60425-20101209				
	Nominal voltage U_N	Nominal current I_N	Cross section AWG	Cross section mm^2
Use group B				
	150 V	5 A	26 - 20	-

 VDE Zeichengenehmigung Approval ID: 40048497				
	Nominal voltage U_N	Nominal current I_N	Cross section AWG	Cross section mm^2
	160 V	6 A	-	0.14 - 0.5

PTSM 0,5/ 4-P-2,5 WH - PCB connector



1704857

<https://www.phoenixcontact.com/pc/products/1704857>

Classifications

ECLASS

ECLASS-11.0	27460202
ECLASS-12.0	27460202
ECLASS-13.0	27460202

ETIM

ETIM 9.0	EC002638
----------	----------

UNSPSC

UNSPSC 21.0	39121400
-------------	----------

PTSM 0,5/ 4-P-2,5 WH - PCB connector



1704857

<https://www.phoenixcontact.com/pc/products/1704857>

Environmental product compliance

EU RoHS

Fulfills EU RoHS substance requirements	Yes, No exemptions
---	--------------------

China RoHS

Environment friendly use period (EFUP)	EFUP-E
	No hazardous substances above the limits

EU REACH SVHC

REACH candidate substance (CAS No.)	No substance above 0.1 wt%
-------------------------------------	----------------------------

EF3.0 Climate Change

CO2e kg	0.028 kg CO2e
---------	---------------

PTSM 0,5/ 4-P-2,5 WH - PCB connector



1704857

<https://www.phoenixcontact.com/pc/products/1704857>

Accessories

SZS 0,4X2,0 - Screwdriver

1205202

<https://www.phoenixcontact.com/pc/products/1205202>



Micro screwdriver, bladed, size: 0.4 x 2.0 x 60 mm, 2-component grip, with non-slip grip and twist cap

AI 0,25- 6 BU - Ferrule

3203040

<https://www.phoenixcontact.com/pc/products/3203040>



Ferrule, sleeve length: 6 mm, color: blue

PTSM 0,5/ 4-P-2,5 WH - PCB connector

1704857

<https://www.phoenixcontact.com/pc/products/1704857>

AI 0,25- 6 YE - Ferrule

3203024

<https://www.phoenixcontact.com/pc/products/3203024>



Ferrule, sleeve length: 6 mm, color: yellow

AI 0,34- 6 TQ - Ferrule

3203053

<https://www.phoenixcontact.com/pc/products/3203053>



Ferrule, sleeve length: 6 mm, color: turquoise

PTSM 0,5/ 4-P-2,5 WH - PCB connector

1704857

<https://www.phoenixcontact.com/pc/products/1704857>

PTSM 0,5/ 4-HH0-2,5-SMD WH R32 - PCB header

1814935

<https://www.phoenixcontact.com/pc/products/1814935>

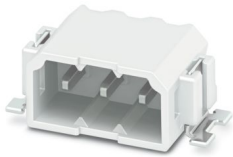

PCB headers, nominal cross section: 0.5 mm², color: signal white, nominal current: 6 A, rated voltage (III/2): 160 V, contact surface: Tin, contact connection type: Pin, number of potentials: 4, number of rows: 1, number of positions: 4, number of connections: 4, product range: PTSM 0,5/..-HH-SMD WH, pitch: 2.5 mm, mounting: SMD soldering, pin layout: Linear pad geometry, number of solder pins per potential: 1, plug-in system: COMBICON PTSM, Pin connector pattern alignment: Standard, locking: without, mounting: without, type of packaging: 32 mm wide tape

PTSM 0,5/ 4-HV-2,5-SMD WH R44 - PCB header

1778719

<https://www.phoenixcontact.com/pc/products/1778719>



PCB headers, nominal cross section: 0.5 mm², color: signal white, nominal current: 6 A, rated voltage (III/2): 160 V, contact surface: Tin, contact connection type: Pin, number of potentials: 4, number of rows: 1, number of positions: 4, number of connections: 4, product range: PTSM 0,5/..-HV-SMD WH, pitch: 2.5 mm, mounting: SMD soldering, pin layout: Linear pad geometry, solder pin [P]: 2 mm, number of solder pins per potential: 1, plug-in system: COMBICON PTSM, Pin connector pattern alignment: Standard, locking: without, mounting: without, type of packaging: 44 mm wide tape, Article with anti-rotation pin

PTSM 0,5/ 4-P-2,5 WH - PCB connector



1704857

<https://www.phoenixcontact.com/pc/products/1704857>

PTSM 0,5/ 4-HV0-2,5-SMD WH R44 - PCB header

1839211

<https://www.phoenixcontact.com/pc/products/1839211>



PCB headers, nominal cross section: 0.5 mm², color: signal white, nominal current: 6 A, rated voltage (III/2): 160 V, contact surface: Tin, contact connection type: Pin, number of potentials: 4, number of rows: 1, number of positions: 4, number of connections: 4, product range: PTSM 0,5/...-HV-SMD WH, pitch: 2.5 mm, mounting: SMD soldering, pin layout: Linear pad geometry, number of solder pins per potential: 1, plug-in system: COMBICON PTSM, Pin connector pattern alignment: Standard, locking: without, mounting: without, type of packaging: 44 mm wide tape

PTSM 0,5/ 4-HTB-2,5-SMD WH R44 - PCB header

1830142

<https://www.phoenixcontact.com/pc/products/1830142>

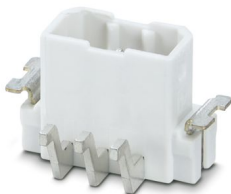

PCB headers, nominal cross section: 0.5 mm², color: signal white, nominal current: 6 A, rated voltage (III/2): 160 V, contact surface: Tin, contact connection type: Pin, number of potentials: 4, number of rows: 1, number of positions: 4, number of connections: 4, product range: PTSM 0,5/...-HTB-SMD WH, pitch: 2.5 mm, mounting: SMD soldering, pin layout: Linear pad geometry, number of solder pins per potential: 1, plug-in system: COMBICON PTSM, Pin connector pattern alignment: Standard, locking: without, mounting: without, type of packaging: 44 mm wide tape

PTSM 0,5/ 4-P-2,5 WH - PCB connector

1704857

<https://www.phoenixcontact.com/pc/products/1704857>

PTSM 0,5/ 4-HH-2,5-THR WH R32 - PCB header

1814867

<https://www.phoenixcontact.com/pc/products/1814867>

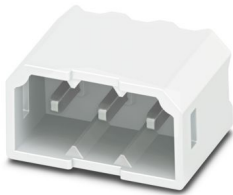

PCB headers, nominal cross section: 0.5 mm², color: signal white, nominal current: 6 A, rated voltage (III/2): 160 V, contact surface: Tin, contact connection type: Pin, number of potentials: 4, number of rows: 1, number of positions: 4, number of connections: 4, product range: PTSM 0,5/...-HH-THR WH, pitch: 2.5 mm, mounting: THR soldering / wave soldering, pin layout: Linear pinning, solder pin [P]: 2.1 mm, number of solder pins per potential: 1, plug-in system: COMBICON PTSM, Pin connector pattern alignment: Standard, locking: without, mounting: without, type of packaging: 32 mm wide tape

PTSM 0,5/ 4-HV-2,5-THR WH R32 - PCB header

1815280

<https://www.phoenixcontact.com/pc/products/1815280>

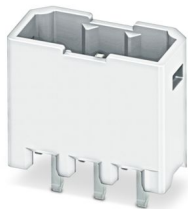

PCB headers, nominal cross section: 0.5 mm², color: signal white, nominal current: 6 A, rated voltage (III/2): 160 V, contact surface: Tin, contact connection type: Pin, number of potentials: 4, number of rows: 1, number of positions: 4, number of connections: 4, product range: PTSM 0,5/...-HV-THR WH, pitch: 2.5 mm, mounting: THR soldering / wave soldering, pin layout: Linear pinning, solder pin [P]: 2 mm, number of solder pins per potential: 1, plug-in system: COMBICON PTSM, Pin connector pattern alignment: Standard, locking: without, mounting: without, type of packaging: 32 mm wide tape

PTSM 0,5/ 4-P-2,5 WH - PCB connector



1704857

<https://www.phoenixcontact.com/pc/products/1704857>

PTSM 0,5/ 4-HH-2,5-SMD WH R32 - PCB header

1708007

<https://www.phoenixcontact.com/pc/products/1708007>

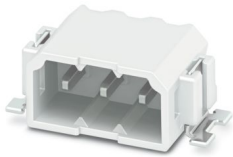

PCB headers, nominal cross section: 0.5 mm², color: signal white, nominal current: 6 A, rated voltage (III/2): 160 V, contact surface: Tin, contact connection type: Pin, number of potentials: 4, number of rows: 1, number of positions: 4, number of connections: 4, product range: PTSM 0,5/..-HH-SMD WH, pitch: 2.5 mm, mounting: SMD soldering, pin layout: Linear pad geometry, solder pin [P]: 2 mm, number of solder pins per potential: 1, plug-in system: COMBICON PTSM, Pin connector pattern alignment: Standard, locking: without, mounting: without, type of packaging: 32 mm wide tape, Article with anti-rotation pin

PTSM 0,5/ 4-PI-2,5 WH - PCB connectors

1709452

<https://www.phoenixcontact.com/pc/products/1709452>



PCB connector, nominal cross section: 0.5 mm², color: white, nominal current: 6 A, rated voltage (III/2): 160 V, contact surface: Tin, contact connection type: Pin, number of potentials: 4, number of rows: 1, number of positions: 4, number of connections: 4, product range: PTSM 0,5/..-PI WH, pitch: 2.5 mm, connection method: Push-in spring connection, conductor/PCB connection direction: 0 °, plug-in system: COMBICON PTSM, locking: without, mounting: without, type of packaging: packed in cardboard

Phoenix Contact 2024 © - all rights reserved
<https://www.phoenixcontact.com>

PHOENIX CONTACT GmbH & Co. KG
Flachsmarktstraße 8
D-32825 Blomberg
+49 (0) 5235-3 00
info@phoenixcontact.com

单击下面可查看定价，库存，交付和生命周期等信息

[>>Phoenix Contact\(菲尼克斯\)](#)