

Printed-circuit board connector - PTSM 0,5/ 2-P-2,5 WH



1704853

<https://www.phoenixcontact.com/in/products/1704853>

Please be informed that the data shown in this PDF document is generated from our Online Catalog. Please find the complete data in the user documentation. Our General Terms of Use for Downloads are valid.



PCB connector, nominal cross section: 0.5 mm², color: white, nominal current: 6 A, rated voltage (III/2): 160 V, contact surface: Tin, type of contact: Female connector, number of potentials: 2, number of rows: 1, number of positions: 2, number of connections: 2, product range: PTSM 0,5/..-P WH, pitch: 2.5 mm, connection method: Push-in spring connection, conductor/PCB connection direction: 0 °, plug-in system: COMBICON COMPACT PTSM, Locking: without, mounting: without, type of packaging: packed in cardboard

Your advantages

- White design: Stable color when welding and during use
- Time saving push-in connection, tools not required
- Defined contact force ensures that contact remains stable over the long term
- High current carrying capacity of 6 A in very compact dimensions

Printed-circuit board connector - PTSM 0,5/ 2-P-2,5 WH



1704853

<https://www.phoenixcontact.com/in/products/1704853>

Commercial Data

Order Key	1704853
Packing unit	250 pc
Minimum order quantity	250 pc
Sales Key	AAC
Product Key	AAAFPA
Catalog Page	Page 395 (C-1-2013)
GTIN	4046356740807
Weight per Piece (including packing)	0.604 g
Weight per Piece (excluding packing)	0.598 g
Customs tariff number	85366990
Country of origin	IN

Printed-circuit board connector - PTSM 0,5/ 2-P-2,5 WH



1704853

<https://www.phoenixcontact.com/in/products/1704853>

Technical Data

Product properties

Type	Standard
Number of positions	2
Number of connections	2
Number of rows	1
Connector system	COMBICON COMPACT PTSM
Mounting flange	without
Number of potentials	2

Electrical properties

Maximum load current	6 A
Rated voltage (II/2)	320 V
Rated voltage (III/2)	160 V
Rated surge voltage (II/2)	2.5 kV
Rated surge voltage (III/2)	2.5 kV
Rated surge voltage (III/3)	2.5 kV
Nominal voltage U_N	100 V
Nominal current I_N	6 A
Nominal current I_N	6 A

Connection data

Connection technology

Type	Standard
Connector system	COMBICON COMPACT PTSM
Nominal cross section	0.5 mm ²
Type of contact	Female connector

Interlock

Locking type	without
Mounting flange	without

Conductor connection

Connection method	Push-in spring connection
Conductor cross section solid	0.14 mm ² ... 0.5 mm ²
Conductor cross section flexible	0.2 mm ² ... 0.5 mm ² (up to 0.75 mm ² supported, with a stripping length of 7.5 mm and a rated insulation voltage of 32 V at III/2)
Conductor cross section AWG	24 ... 20
Conductor cross section flexible, with ferrule without plastic sleeve	0.25 mm ² ... 0.5 mm ²
Conductor cross section, flexible, with ferrule, with plastic sleeve	0.25 mm ² ... 0.34 mm ²
Cylindrical gauge a x b / diameter	- / 1.2 mm
Stripping length	6 mm

Printed-circuit board connector - PTSM 0,5/ 2-P-2,5 WH



1704853

<https://www.phoenixcontact.com/in/products/1704853>

Material specifications

Material data - contact

Note	WEEE/RoHS-compliant, free of whiskers according to IEC 60068-2-82/JEDEC JESD 201
Contact material	Cu alloy
Surface characteristics	hot-dip tin-plated
Metal surface terminal point (top layer)	Tin (4 - 8 µm Sn)
Metal surface contact area (top layer)	Tin (4 - 8 µm Sn)

Material data - housing

Housing color	white (9010)
Insulating material	PA
Insulating material group	I
CTI according to IEC 60112	600
Flammability rating according to UL 94	V0
Glow wire flammability index GWFI according to EN 60695-2-12	850
Glow wire ignition temperature GWIT according to EN 60695-2-13	775
Temperature for the ball pressure test according to EN 60695-10-2	125 °C

Dimensions

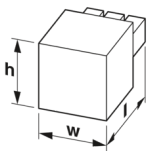
Dimensional drawing	
Width	6.1 mm
Height	5 mm
Length	15 mm
Pitch	2.5 mm

Mechanical tests

Test for conductor damage and slackening

Specification	IEC 60999-1:1999-11
Result	Test passed

Repeated connection and disconnection

Specification	IEC 60999-1:1999-11
Result	Test passed

Pull-out test

Specification	IEC 60999-1:1999-11 0.14 mm ² / solid / > 10 N
---------------	--

Printed-circuit board connector - PTSM 0,5/ 2-P-2,5 WH



1704853

<https://www.phoenixcontact.com/in/products/1704853>

Conductor cross section/conductor type/tractive force setpoint/actual value	0.2 mm ² / flexible / > 10 N
	0.5 mm ² / solid / > 20 N
	0.75 mm ² / flexible / > 30 N

Insertion and withdrawal forces

Result	Test passed
No. of cycles	10
Insertion strength per pos. approx.	5 N
Withdraw strength per pos. approx.	3 N

Contact holder in insert

Specification	IEC 60512-15-1:2008-05
Result	Test passed
Test force per pos.	20 N

Resistance of inscriptions

Specification	IEC 60068-2-70:1995-12
Result	Test passed

Polarization and coding

Specification	IEC 60512-13-5:2006-02
Result	Test passed

Visual inspection

Specification	IEC 60512-1-1:2002-02
Result	Test passed

Dimension check

Specification	IEC 60512-1-2:2002-02
Result	Test passed

Environmental and real-life conditions

Vibration test

Specification	IEC 60068-2-6:2007-12
Frequency	10 - 150 - 10 Hz
Sweep speed	1 octave/min
Amplitude	0.35 mm (10 - 60.1 Hz)
Sweep speed	5g (60.1 - 150 Hz)
Test duration per axis	2.5 h

Durability test

Specification	IEC 60512-9-1:2010-03
Impulse withstand voltage at sea level	2.95 kV
Contact resistance R ₁	2.4 mΩ
Contact resistance R ₂	2.3 mΩ
Insertion/withdrawal cycles	10
Insulation resistance, neighboring positions	> 5 MΩ

Printed-circuit board connector - PTSM 0,5/ 2-P-2,5 WH



1704853

<https://www.phoenixcontact.com/in/products/1704853>

Climatic test

Specification	ISO 6988:1985-02
Corrosive stress	0.2 dm ³ SO ₂ on 300 dm ³ /40 °C/1 cycle
Thermal stress	100 °C/168 h
Power-frequency withstand voltage	1.39 kV

Ambient conditions

Ambient temperature (operation)	-40 °C ... 100 °C (dependent on the derating curve)
Ambient temperature (storage/transport)	-40 °C ... 70 °C
Relative humidity (storage/transport)	30 % ... 70 %
Ambient temperature (assembly)	-5 °C ... 100 °C

Electrical tests

Electrical properties

Rated voltage (III/2)	160 V
Rated surge voltage (III/2)	2.5 kV
Contact resistance	2.4 mΩ
Pollution degree	2

Thermal test | Test group C

Specification	IEC 60512-5-1:2002-02
Tested number of positions	8

Insulation resistance

Specification	IEC 60512-3-1:2002-02
Insulation resistance, neighboring positions	> 5 MΩ

Temperature cycles

Specification	IEC 60999-1:1999-11
Result	Test passed

Air clearances and creepage distances |

Specification	IEC 60664-1:2007-04
Insulating material group	I
Comparative tracking index (IEC 60112:2003-01)	CTI 600
Rated insulation voltage (III/3)	100 V
Rated surge voltage (III/3)	2.5 kV
minimum clearance value - non-homogenous field (III/3)	1.5 mm
minimum creepage distance (III/3)	1.8 mm
Rated insulation voltage (III/2)	160 V
Rated surge voltage (III/2)	2.5 kV
minimum clearance value - non-homogenous field (III/2)	1.5 mm
minimum creepage distance (III/2)	1.5 mm
Rated insulation voltage (II/2)	320 V
Rated surge voltage (II/2)	2.5 kV

Printed-circuit board connector - PTSM 0,5/ 2-P-2,5 WH



1704853

<https://www.phoenixcontact.com/in/products/1704853>

minimum clearance value - non-homogenous field (I/2)	1.5 mm
minimum creepage distance (I/2)	1.6 mm

Packaging specifications

Type of packaging	packed in cardboard
Outer packaging type	Carton

1704853

<https://www.phoenixcontact.com/in/products/1704853>

Drawings

Diagram

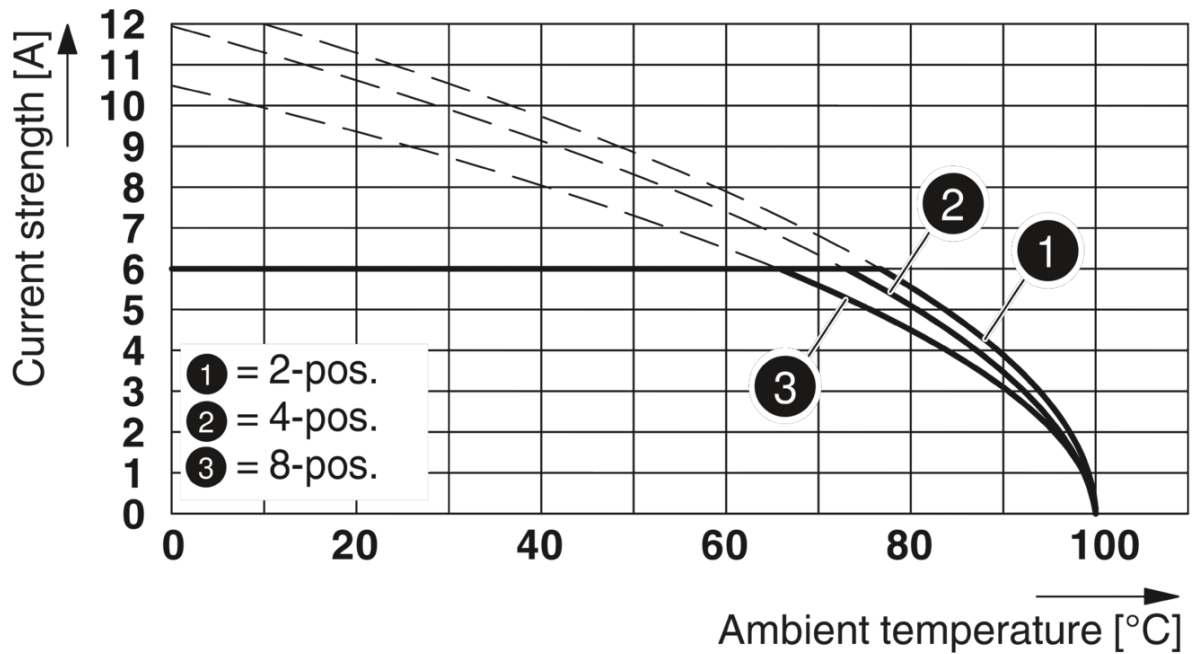

Derating curve for: PTSM 0,5/...-P-2,5 with PTSM 0,5/...-HH-2,5-SMD R..

Diagram

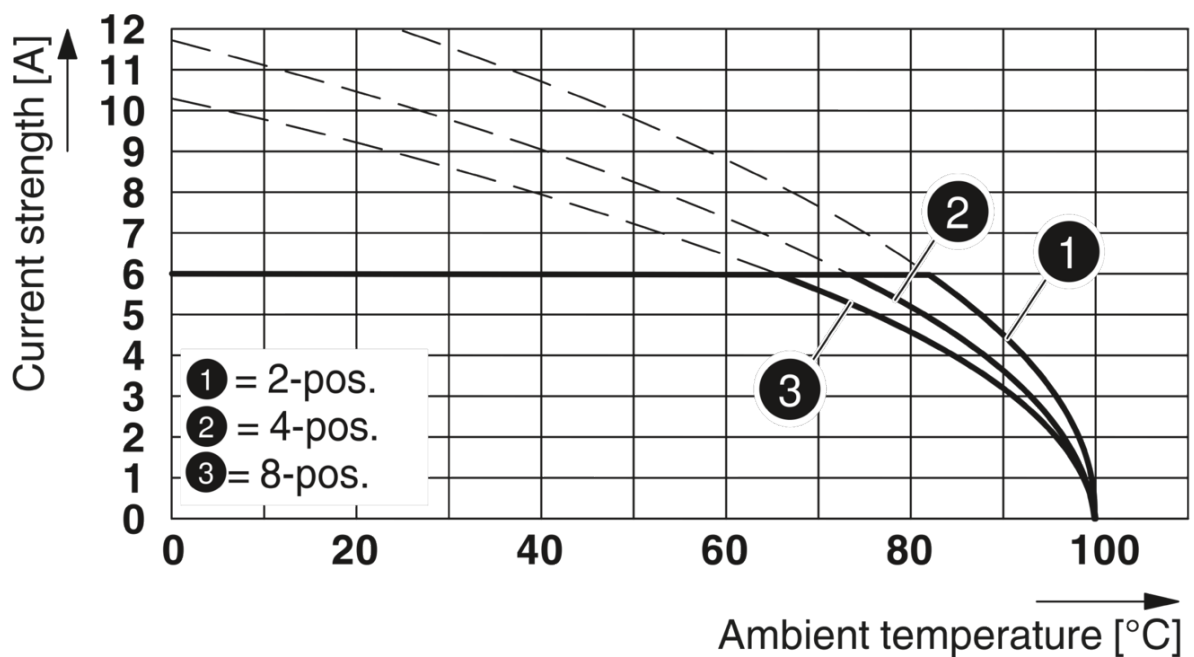

Derating curve for: PTSM 0,5/...-P-2,5 with PTSM 0,5/...-HV-2,5-THR R..

1704853

<https://www.phoenixcontact.com/in/products/1704853>

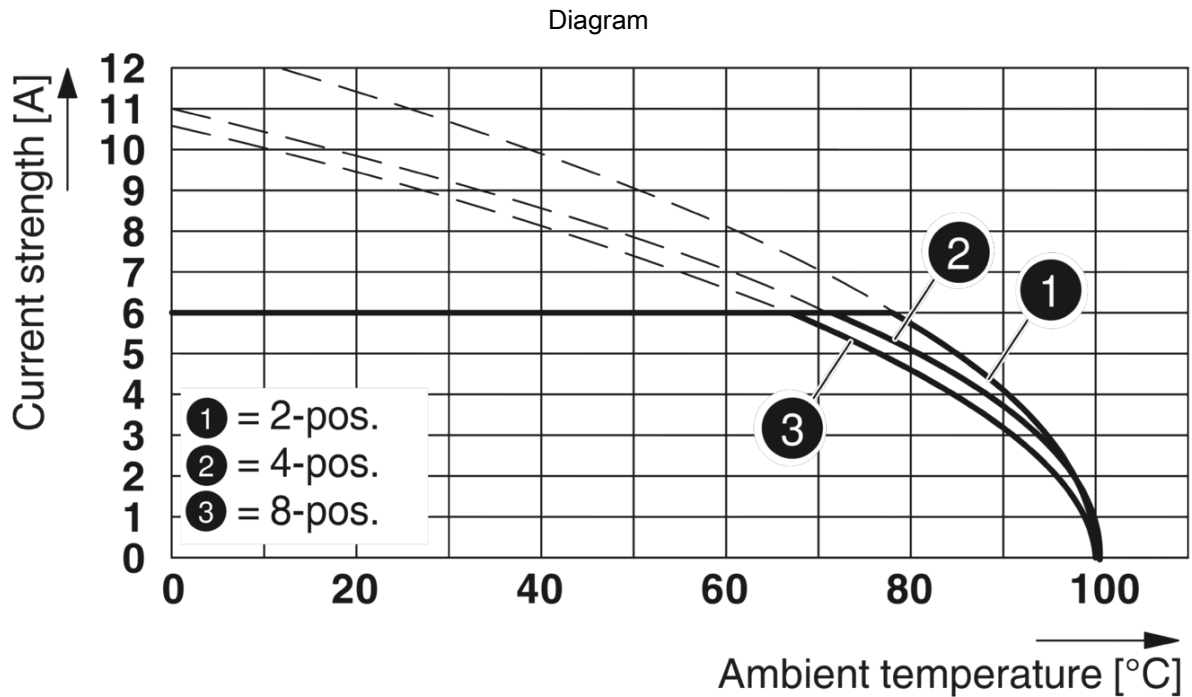

Derating curve for: PTSM 0,5/..-P-2,5 with PTSM 0,5/..-HH-2,5-THR R..

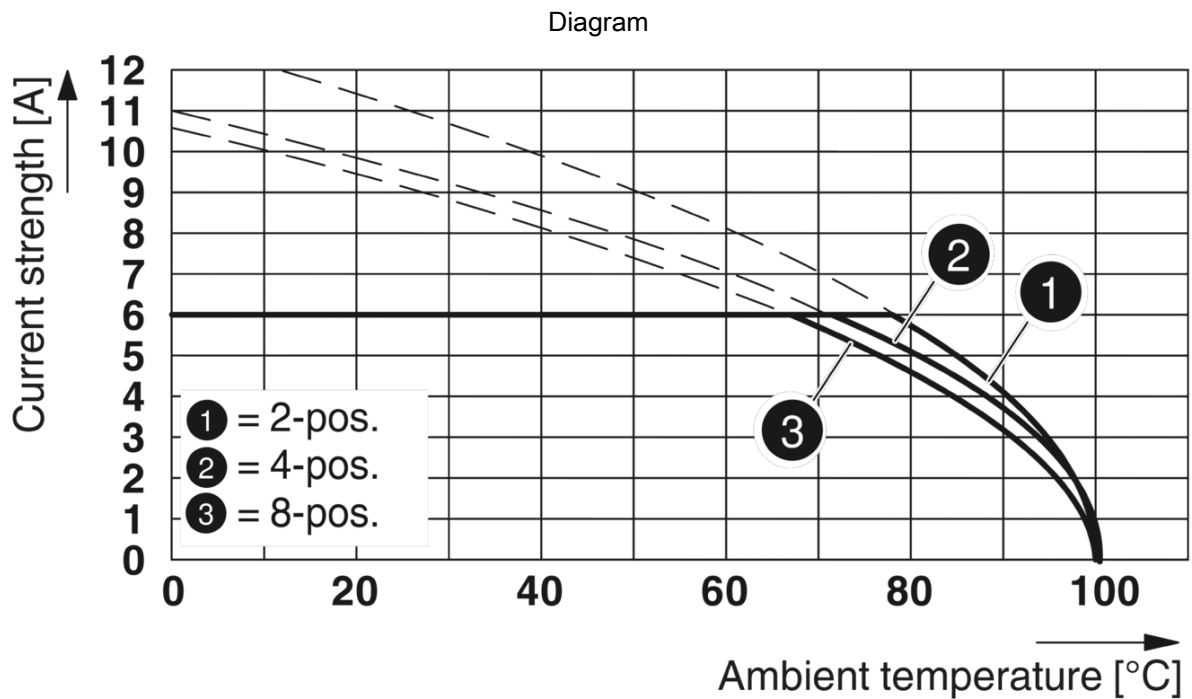

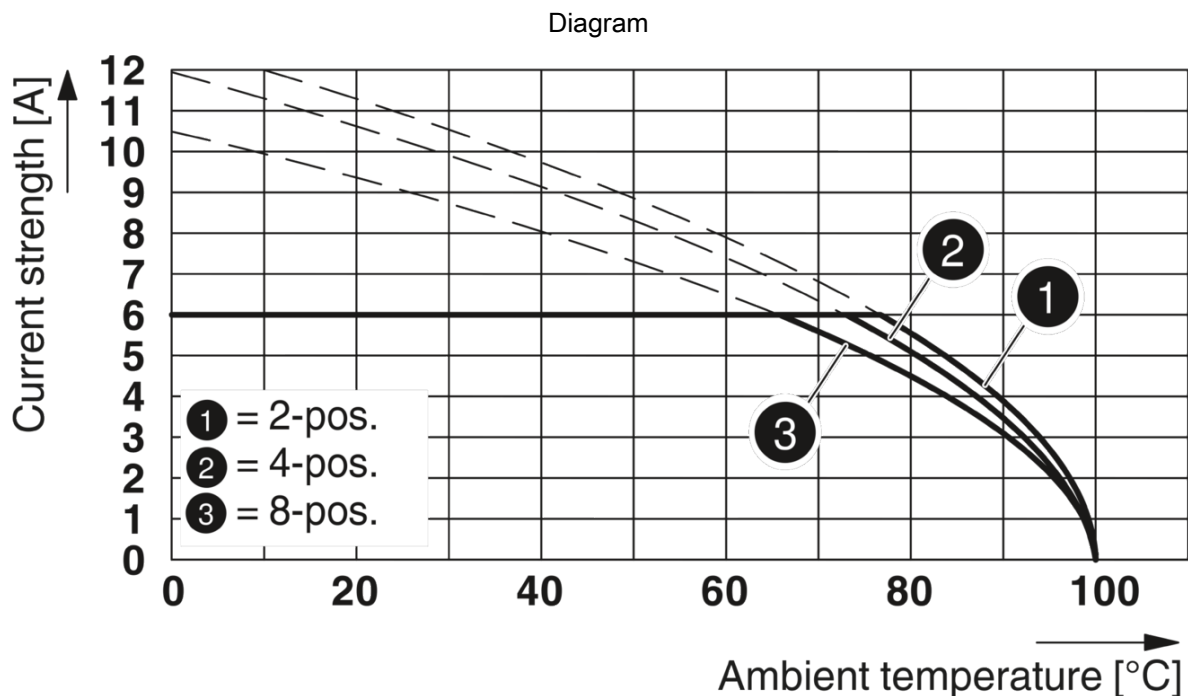
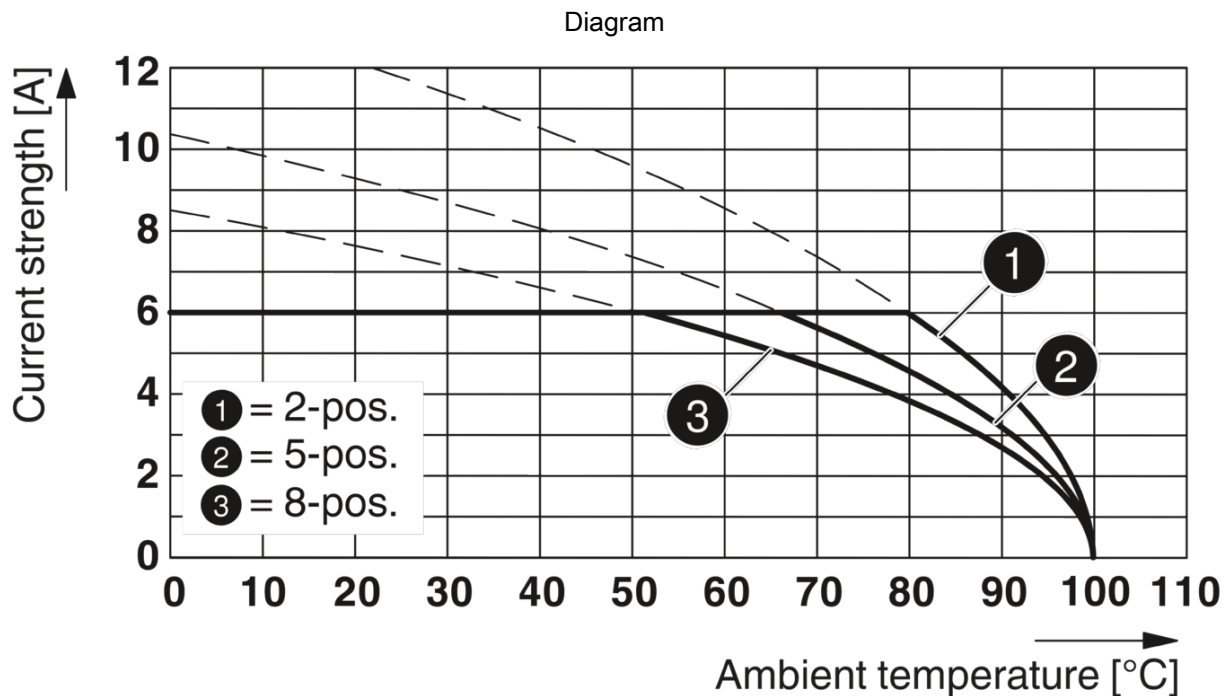

Printed-circuit board connector - PTSM 0,5/ 2-P-2,5 WH



1704853

<https://www.phoenixcontact.com/in/products/1704853>

Dimensional drawing

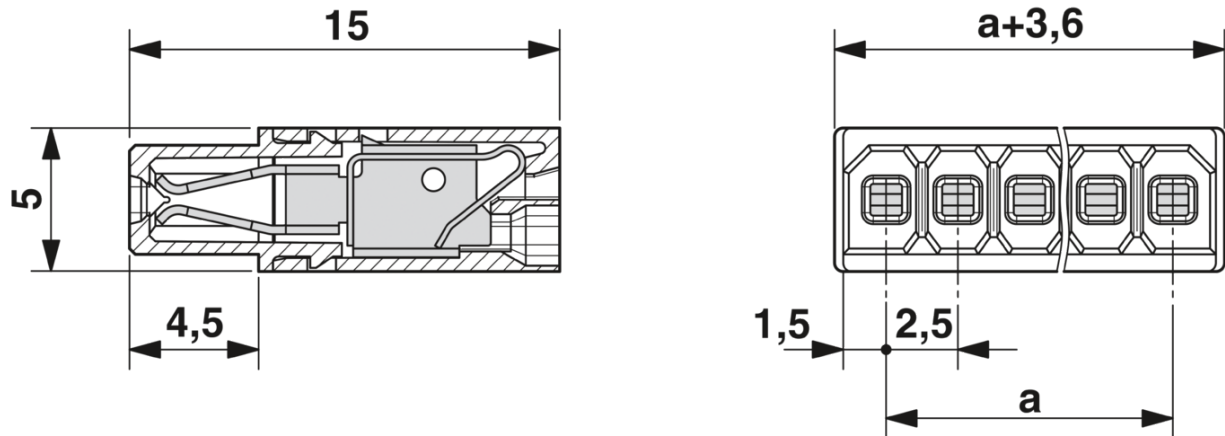

Diagram

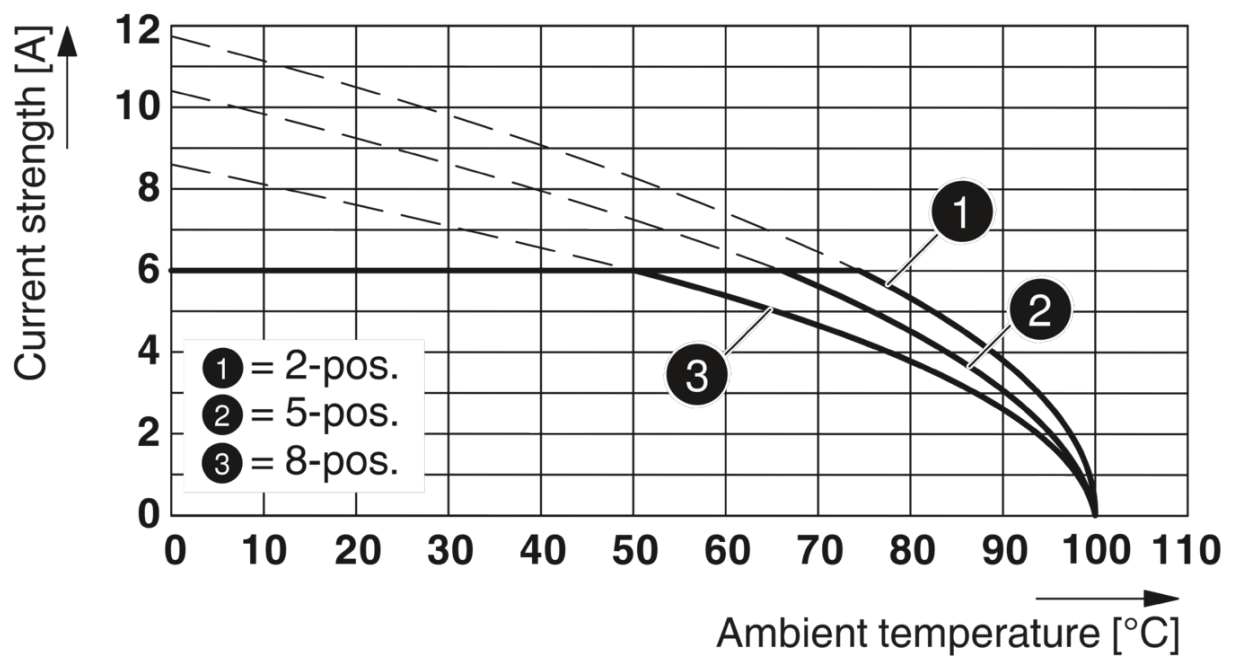

Printed-circuit board connector - PTSM 0,5/ 2-P-2,5 WH



1704853

<https://www.phoenixcontact.com/in/products/1704853>

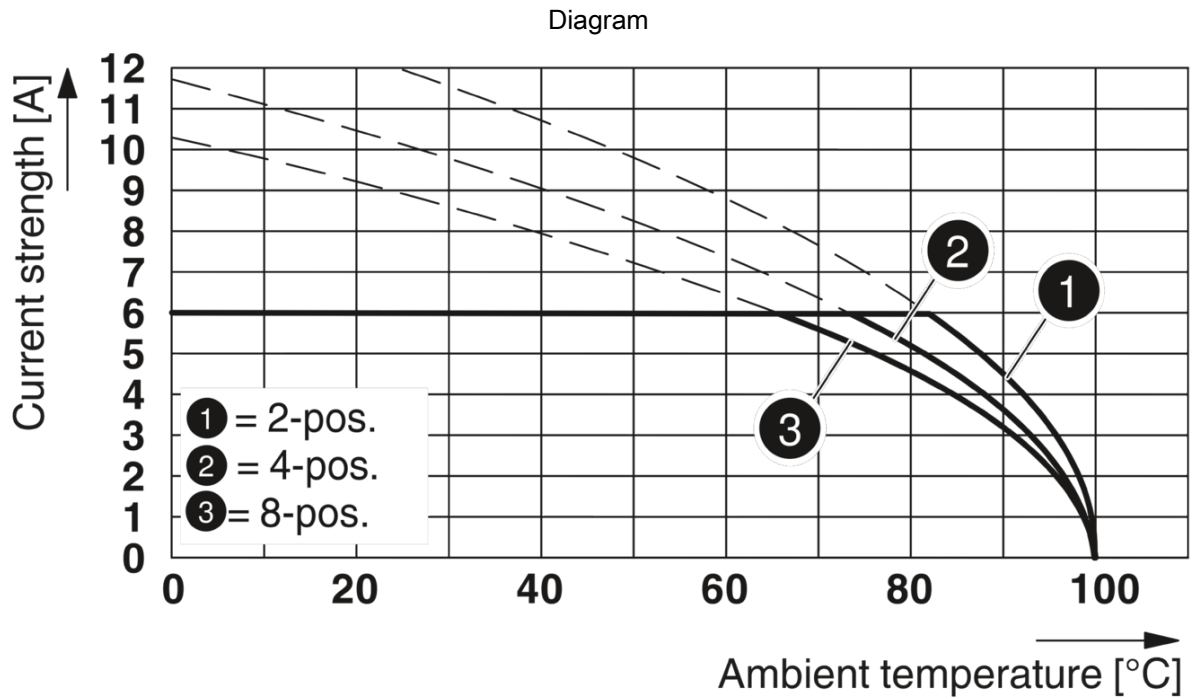

Printed-circuit board connector - PTSM 0,5/ 2-P-2,5 WH



1704853

<https://www.phoenixcontact.com/in/products/1704853>

Approvals

UL Recognized 	Nominal Voltage U_N	Nominal Current I_N	Cross Section AWG	Cross Section mm^2
Use group B				
	150 V	5 A	26 - 18	-

EAC

cULus Recognized 	Nominal Voltage U_N	Nominal Current I_N	Cross Section AWG	Cross Section mm^2
Use group B				
	150 V	5 A	26 - 20	-

VDE Zeichengenehmigung 	Nominal Voltage U_N	Nominal Current I_N	Cross Section AWG	Cross Section mm^2
	160 V	6 A	-	0.14 - 0.5

Printed-circuit board connector - PTSM 0,5/ 2-P-2,5 WH



1704853

<https://www.phoenixcontact.com/in/products/1704853>

Classifications

ECLASS

ECLASS-9.0	27440309
ECLASS-10.0.1	27440309
ECLASS-11.0	27460202

ETIM

ETIM 6.0	EC002638
----------	----------

UNSPSC

UNSPSC 19.0	39121409
UNSPSC 20.0	39121409
UNSPSC 21.0	39121409

Printed-circuit board connector - PTSM 0,5/ 2-P-2,5 WH



1704853

<https://www.phoenixcontact.com/in/products/1704853>

Environmental Product Compliance

China RoHS	Environmentally friendly use period: unlimited = EFUP-e
	No hazardous substances above threshold values

Printed-circuit board connector - PTSM 0,5/ 2-P-2,5 WH



1704853

<https://www.phoenixcontact.com/in/products/1704853>

Accessories

Screwdriver

Screwdriver - SZS 0,4X2,0 - 1205202



Micro screwdriver, bladed, size: 0.4 x 2.0 x 60 mm, 2-component grip, with non-slip grip and twist cap

Ferrule

Ferrule - AI 0,25- 6 BU - 3203040



Ferrule, sleeve length: 6 mm, length: 10.5 mm, color: blue

Printed-circuit board connector - PTSM 0,5/ 2-P-2,5 WH



1704853

<https://www.phoenixcontact.com/in/products/1704853>

Ferrule

Ferrule - AI 0,25- 6 YE - 3203024



Ferrule, sleeve length: 6 mm, length: 10.5 mm, color: yellow

Ferrule

Ferrule - AI 0,34- 6 TQ - 3203053



Ferrule, sleeve length: 6 mm, length: 10.5 mm, color: turquoise

Printed-circuit board connector - PTSM 0,5/ 2-P-2,5 WH



1704853

<https://www.phoenixcontact.com/in/products/1704853>

PCB header

PCB header - PTSM 0,5/ 2-HH-2,5-SMD WH R32 - 1708004

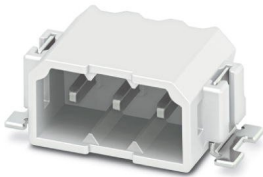

PCB headers, nominal cross section: 0.5 mm², color: signal white, nominal current: 6 A, rated voltage (III/2): 160 V, contact surface: Tin, type of contact: Male connector, number of potentials: 2, number of rows: 1, number of positions: 2, number of connections: 2, product range: PTSM 0,5/..-HH-SMD WH, pitch: 2.5 mm, mounting: SMD soldering, pin layout: Linear pad geometry, solder pin [P]: 2 mm, number of solder pins per potential: 1, plug-in system: COMBICON COMPACT PTSM, Pin connector pattern alignment: Standard, Locking: without, mounting: without, type of packaging: 32 mm wide tape, Article with anti-rotation pin

PCB header

PCB header - PTSM 0,5/ 2-HH0-2,5-SMD WH R32 - 1814919

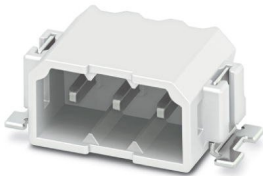

PCB headers, nominal cross section: 0.5 mm², color: signal white, nominal current: 6 A, rated voltage (III/2): 160 V, contact surface: Tin, type of contact: Male connector, number of potentials: 2, number of rows: 1, number of positions: 2, number of connections: 2, product range: PTSM 0,5/..-HH-SMD WH, pitch: 2.5 mm, mounting: SMD soldering, pin layout: Linear pad geometry, number of solder pins per potential: 1, plug-in system: COMBICON COMPACT PTSM, Pin connector pattern alignment: Standard, Locking: without, mounting: without, type of packaging: 32 mm wide tape

Printed-circuit board connector - PTSM 0,5/ 2-P-2,5 WH



1704853

<https://www.phoenixcontact.com/in/products/1704853>

PCB header

PCB header - PTSM 0,5/ 2-HV-2,5-SMD WH R24 - 1778696

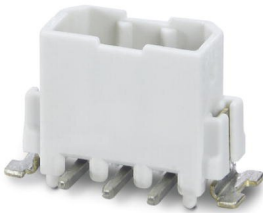

PCB headers, nominal cross section: 0.5 mm², color: signal white, nominal current: 6 A, rated voltage (III/2): 160 V, contact surface: Tin, type of contact: Male connector, number of potentials: 2, number of rows: 1, number of positions: 2, number of connections: 2, product range: PTSM 0,5/..-HV-SMD WH, pitch: 2.5 mm, mounting: SMD soldering, pin layout: Linear pad geometry, solder pin [P]: 2 mm, number of solder pins per potential: 1, plug-in system: COMBICON COMPACT PTSM, Pin connector pattern alignment: Standard, Locking: without, mounting: without, type of packaging: 24 mm wide tape, Article with anti-rotation pin

PCB header

PCB header - PTSM 0,5/ 2-HV0-2,5-SMD WH R24 - 1839198

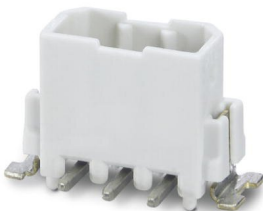

PCB headers, nominal cross section: 0.5 mm², color: signal white, nominal current: 6 A, rated voltage (III/2): 160 V, contact surface: Tin, type of contact: Male connector, number of potentials: 2, number of rows: 1, number of positions: 2, number of connections: 2, product range: PTSM 0,5/..-HV-SMD WH, pitch: 2.5 mm, mounting: SMD soldering, pin layout: Linear pad geometry, number of solder pins per potential: 1, plug-in system: COMBICON COMPACT PTSM, Pin connector pattern alignment: Standard, Locking: without, mounting: without, type of packaging: 24 mm wide tape

Printed-circuit board connector - PTSM 0,5/ 2-P-2,5 WH



1704853

<https://www.phoenixcontact.com/in/products/1704853>

PCB header

PCB header - PTSM 0,5/ 2-HTB-2,5-SMD WH R24 - 1830126

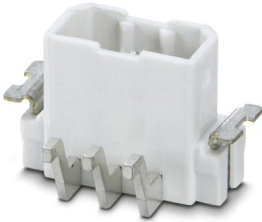

PCB headers, nominal cross section: 0.5 mm², color: signal white, nominal current: 6 A, rated voltage (III/2): 160 V, contact surface: Tin, type of contact: Male connector, number of potentials: 2, number of rows: 1, number of positions: 2, number of connections: 2, product range: PTSM 0,5/..-HTB-SMD WH, pitch: 2.5 mm, mounting: SMD soldering, pin layout: Linear pad geometry, number of solder pins per potential: 1, plug-in system: COMBICON COMPACT PTSM, Pin connector pattern alignment: Standard, Locking: without, mounting: without, type of packaging: 24 mm wide tape

PCB header

PCB header - PTSM 0,5/ 2-HH-2,5-THR WH R16 - 1814841

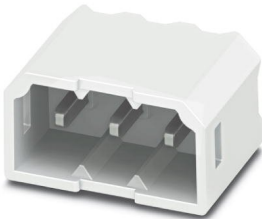

PCB headers, nominal cross section: 0.5 mm², color: signal white, nominal current: 6 A, rated voltage (III/2): 160 V, contact surface: Tin, type of contact: Male connector, number of potentials: 2, number of rows: 1, number of positions: 2, number of connections: 2, product range: PTSM 0,5/..-HH-THR WH, pitch: 2.5 mm, mounting: THR soldering, pin layout: Linear pinning, solder pin [P]: 2.1 mm, number of solder pins per potential: 1, plug-in system: COMBICON COMPACT PTSM, Pin connector pattern alignment: Standard, Locking: without, mounting: without, type of packaging: 16 mm wide tape

Printed-circuit board connector - PTSM 0,5/ 2-P-2,5 WH



1704853

<https://www.phoenixcontact.com/in/products/1704853>

PCB header

PCB header - PTSM 0,5/ 2-HV-2,5-THR WH R32 - 1815264

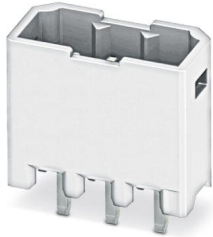

PCB headers, nominal cross section: 0.5 mm², color: signal white, nominal current: 6 A, rated voltage (III/2): 160 V, contact surface: Tin, type of contact: Male connector, number of potentials: 2, number of rows: 1, number of positions: 2, number of connections: 2, product range: PTSM 0,5/..-HV-THR WH, pitch: 2.5 mm, mounting: THR soldering, pin layout: Linear pinning, solder pin [P]: 2 mm, number of solder pins per potential: 1, plug-in system: COMBICON COMPACT PTSM, Pin connector pattern alignment: Standard, Locking: without, mounting: without, type of packaging: 32 mm wide tape

PCB header

PCB header - PTSM 0,5/ 8-HH-2,5-SMD R44 - 1778829



PCB headers, nominal cross section: 0.5 mm², color: black, nominal current: 6 A, rated voltage (III/2): 160 V, contact surface: Tin, type of contact: Male connector, number of potentials: 8, number of rows: 1, number of positions: 8, number of connections: 8, product range: PTSM 0,5/..-HH-SMD, pitch: 2.5 mm, mounting: SMD soldering, pin layout: Linear pad geometry, solder pin [P]: 2 mm, number of solder pins per potential: 1, plug-in system: COMBICON COMPACT PTSM, Pin connector pattern alignment: Standard, Locking: without, mounting: without, type of packaging: 44 mm wide tape, Article with anti-rotation pin

Phoenix Contact 2022 © - all rights reserved
<https://www.phoenixcontact.com>

PHOENIX CONTACT (I) Pvt. Ltd.
A-58/2, Okhla Industrial Area, Phase - II, New Delhi-110 020

+91.1275.71420
info@phoenixcontact.co.in

单击下面可查看定价，库存，交付和生命周期等信息

[>>Phoenix Contact\(菲尼克斯\)](#)