

GMSTB 2,5/ 2-ST-7,62 - PCB connector



1766990

<https://www.phoenixcontact.com/us/products/1766990>

Please be informed that the data shown in this PDF document is generated from our online catalog. Please find the complete data in the user documentation. Our general terms of use for downloads are valid.



PCB connector, nominal cross section: 2.5 mm², color: green, nominal current: 12 A, rated voltage (III/2): 630 V, contact surface: Tin, contact connection type: Socket, number of potentials: 2, number of rows: 1, number of positions: 2, number of connections: 2, product range: GMSTB 2,5/...-ST, pitch: 7.62 mm, connection method: Screw connection with tension sleeve, screw head form: L Slotted, conductor/PCB connection direction: 0 °, locking clip: - Locking clip, plug-in system: COMBICON MSTB 2,5, locking: without, mounting: without, type of packaging: packed in cardboard

Your advantages

- Well-known connection principle allows worldwide use
- Low temperature rise, thanks to maximum contact force
- Larger pitch for increased voltage requirements
- Allows connection of two conductors

Commercial data

| | |
|--------------------------------------|---------------------|
| Item number | 1766990 |
| Packing unit | 1 pc |
| Minimum order quantity | 50 pc |
| Sales key | AA03 |
| Product key | AACAIB |
| Catalog page | Page 334 (C-1-2013) |
| GTIN | 4017918033019 |
| Weight per piece (including packing) | 3.919 g |
| Weight per piece (excluding packing) | 3.712 g |
| Customs tariff number | 85366990 |
| Country of origin | DE |

GMSTB 2,5/ 2-ST-7,62 - PCB connector



1766990

<https://www.phoenixcontact.com/us/products/1766990>

Technical data

Product properties

| | |
|-----------------------|-----------------------|
| Type | Standard |
| Product line | COMBICON Connectors M |
| Product type | PCB connector |
| Product family | GMSTB 2,5/..-ST |
| Number of positions | 2 |
| Pitch | 7.62 mm |
| Number of connections | 2 |
| Number of rows | 1 |
| Mounting flange | without |
| Number of potentials | 2 |

Electrical properties

| | |
|-----------------------------|----------------|
| Nominal current I_N | 12 A |
| Nominal voltage U_N | 630 V |
| Degree of pollution | 3 |
| Contact resistance | 1.3 m Ω |
| Rated voltage (III/3) | 400 V |
| Rated surge voltage (III/3) | 6 kV |
| Rated voltage (III/2) | 630 V |
| Rated surge voltage (III/2) | 6 kV |
| Rated voltage (II/2) | 1000 V |
| Rated surge voltage (II/2) | 6 kV |

Connection data

Connection technology

| | |
|-------------------------|---------------------|
| Type | Standard |
| Connector system | COMBICON MSTB 2,5 |
| Nominal cross section | 2.5 mm ² |
| Contact connection type | Socket |

Interlock

| | |
|-----------------|---------|
| Locking type | without |
| Mounting flange | without |

Conductor connection

| | |
|--|--|
| Connection method | Screw connection with tension sleeve |
| Conductor/PCB connection direction | 0 ° |
| Conductor cross section rigid | 0.2 mm ² ... 2.5 mm ² |
| Conductor cross section flexible | 0.2 mm ² ... 2.5 mm ² |
| Conductor cross section AWG | 24 ... 12 |
| Conductor cross section flexible, with ferrule without plastic | 0.25 mm ² ... 2.5 mm ² |

GMSTB 2,5/ 2-ST-7,62 - PCB connector

1766990

<https://www.phoenixcontact.com/us/products/1766990>

| | |
|---|--|
| sleeve | |
| Conductor cross section, flexible, with ferrule, with plastic sleeve | 0.25 mm ² ... 2.5 mm ² |
| 2 conductors with same cross section, solid | 0.2 mm ² ... 1 mm ² |
| 2 conductors with same cross section, flexible | 0.2 mm ² ... 1.5 mm ² |
| 2 conductors with same cross section, flexible, with ferrule without plastic sleeve | 0.25 mm ² ... 1 mm ² |
| 2 conductors with the same cross section, flexible, with TWIN ferrule with plastic sleeve | 0.5 mm ² ... 1 mm ² |
| Cylindrical gauge a x b / diameter | 2.8 mm x 2.0 mm / 2.4 mm |
| Stripping length | 7 mm |
| Tightening torque | 0.5 Nm ... 0.6 Nm |

Material specifications

Material data - contact

| | |
|--|--|
| Note | WEEE/RoHS-compliant, free of whiskers according to IEC 60068-2-82/JEDEC JESD 201 |
| Contact material | Cu alloy |
| Surface characteristics | hot-dip tin-plated |
| Metal surface terminal point (top layer) | Tin (5 - 7 µm Sn) |
| Metal surface contact area (top layer) | Tin (5 - 7 µm Sn) |

Material data - housing

| | |
|---|--------------|
| Color (Housing) | green (6021) |
| Insulating material | PA |
| Insulating material group | I |
| CTI according to IEC 60112 | 600 |
| Flammability rating according to UL 94 | V0 |
| Glow wire flammability index GWFI according to EN 60695-2-12 | 850 |
| Glow wire ignition temperature GWIT according to EN 60695-2-13 | 775 |
| Temperature for the ball pressure test according to EN 60695-10-2 | 125 °C |

Dimensions

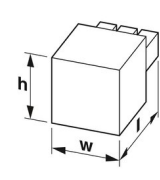
| | |
|---------------------|--|
| Dimensional drawing |  |
| Pitch | 7.62 mm |
| Width [w] | 13.24 mm |
| Height [h] | 15 mm |
| Length [l] | 18.2 mm |

Mounting

GMSTB 2,5/ 2-ST-7,62 - PCB connector



1766990

<https://www.phoenixcontact.com/us/products/1766990>

| | |
|-----------------------|--------------------------------------|
| Drive form screw head | Slotted (L) |
| Connection method | Screw connection with tension sleeve |
| Drive form screw head | Slotted (L) |

Notes

| | |
|--------------------|--|
| Notes on operation | In accordance with IEC 61984, COMBICON connectors have no switching power (COC). During designated use, they must not be plugged in or disconnected when carrying voltage or under load. |
|--------------------|--|

Mechanical tests

Test for conductor damage and slackening

| | |
|---------------|---------------------|
| Specification | IEC 60999-1:1999-11 |
| Result | Test passed |

Pull-out test

| | |
|---|---|
| Specification | IEC 60999-1:1999-11 |
| Conductor cross section/conductor type/tractive force setpoint/actual value | 0.2 mm ² / solid / > 10 N |
| | 0.2 mm ² / flexible / > 10 N |
| | 2.5 mm ² / solid / > 50 N |
| | 2.5 mm ² / flexible / > 50 N |

Insertion and withdrawal forces

| | |
|-------------------------------------|-------------|
| Result | Test passed |
| No. of cycles | 25 |
| Insertion strength per pos. approx. | 8 N |
| Withdraw strength per pos. approx. | 6 N |

Torque test

| | |
|---------------|---------------------|
| Specification | IEC 60999-1:1999-11 |
|---------------|---------------------|

Resistance of inscriptions

| | |
|---------------|------------------------|
| Specification | IEC 60068-2-70:1995-12 |
| Result | Test passed |

Polarization and coding

| | |
|---------------|------------------------|
| Specification | IEC 60512-13-5:2006-02 |
| Result | Test passed |

Visual inspection

| | |
|---------------|-----------------------|
| Specification | IEC 60512-1-1:2002-02 |
| Result | Test passed |

Dimension check

| | |
|---------------|-----------------------|
| Specification | IEC 60512-1-2:2002-02 |
| Result | Test passed |

Environmental and real-life conditions

GMSTB 2,5/ 2-ST-7,62 - PCB connector



1766990

<https://www.phoenixcontact.com/us/products/1766990>

Vibration test

| | |
|------------------------|-----------------------------|
| Specification | IEC 60068-2-6:2007-12 |
| Frequency | 10 - 150 - 10 Hz |
| Sweep speed | 1 octave/min |
| Amplitude | 0.35 mm (10 Hz ... 60.1 Hz) |
| Sweep speed | 5g (60.1 Hz ... 150 Hz) |
| Test duration per axis | 2.5 h |

Durability test

| | |
|--|-----------------------|
| Specification | IEC 60512-9-1:2010-03 |
| Impulse withstand voltage at sea level | 7.3 kV |
| Contact resistance R ₁ | 1.3 mΩ |
| Contact resistance R ₂ | 1.3 mΩ |
| Insertion/withdrawal cycles | 25 |
| Insulation resistance, neighboring positions | > 5 MΩ |

Climatic test

| | |
|-----------------------------------|---|
| Specification | ISO 6988:1985-02 |
| Corrosive stress | 0.2 dm ³ SO ₂ on 300 dm ³ /40 °C/1 cycle |
| Thermal stress | 100 °C/168 h |
| Power-frequency withstand voltage | 3.31 kV |

Ambient conditions

| | |
|---|---|
| Ambient temperature (operation) | -40 °C ... 100 °C (dependent on the derating curve) |
| Ambient temperature (storage/transport) | -40 °C ... 70 °C |
| Relative humidity (storage/transport) | 30 % ... 70 % |
| Ambient temperature (assembly) | -5 °C ... 100 °C |

Electrical tests

Thermal test | Test group C

| | |
|----------------------------|-----------------------|
| Specification | IEC 60512-5-1:2002-02 |
| Tested number of positions | 12 |

Insulation resistance

| | |
|--|-----------------------|
| Specification | IEC 60512-3-1:2002-02 |
| Insulation resistance, neighboring positions | > 5 MΩ |

Air clearances and creepage distances |

| | |
|--|---------------------|
| Specification | IEC 60664-1:2007-04 |
| Insulating material group | I |
| Comparative tracking index (IEC 60112) | CTI 600 |
| Rated insulation voltage (III/3) | 400 V |
| Rated surge voltage (III/3) | 6 kV |
| minimum clearance value - non-homogenous field (III/3) | 5.5 mm |
| minimum creepage distance (III/3) | 5.5 mm |

GMSTB 2,5/ 2-ST-7,62 - PCB connector



1766990

<https://www.phoenixcontact.com/us/products/1766990>

| | |
|--|--|
| Note on connection cross section | With connected conductor 2.5 mm ² (stranded). |
| Rated insulation voltage (III/2) | 630 V |
| Rated surge voltage (III/2) | 6 kV |
| minimum clearance value - non-homogenous field (III/2) | 5.5 mm |
| minimum creepage distance (III/2) | 5.5 mm |
| Rated insulation voltage (II/2) | 1000 V |
| Rated surge voltage (II/2) | 6 kV |
| minimum clearance value - non-homogenous field (II/2) | 5.5 mm |
| minimum creepage distance (II/2) | 5.5 mm |

Packaging specifications

| | |
|-------------------|---------------------|
| Type of packaging | packed in cardboard |
|-------------------|---------------------|

GMSTB 2,5/ 2-ST-7,62 - PCB connector



1766990

<https://www.phoenixcontact.com/us/products/1766990>

Drawings

Diagram

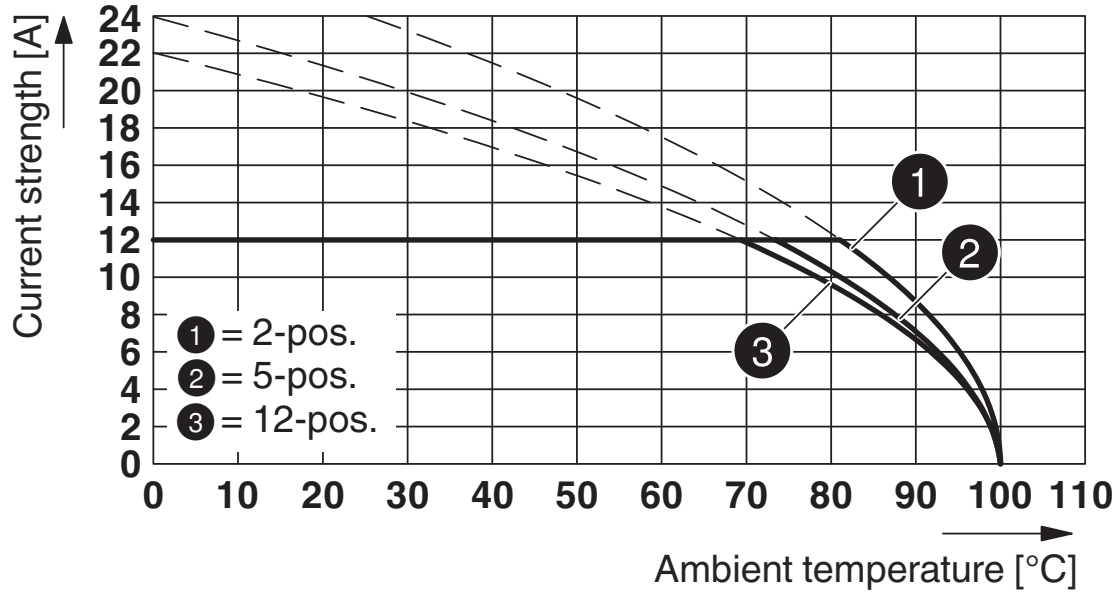

Type: GMSTB 2,5/...-ST-7,62 with GMSTB 2,5/...-G-7,62

Diagram

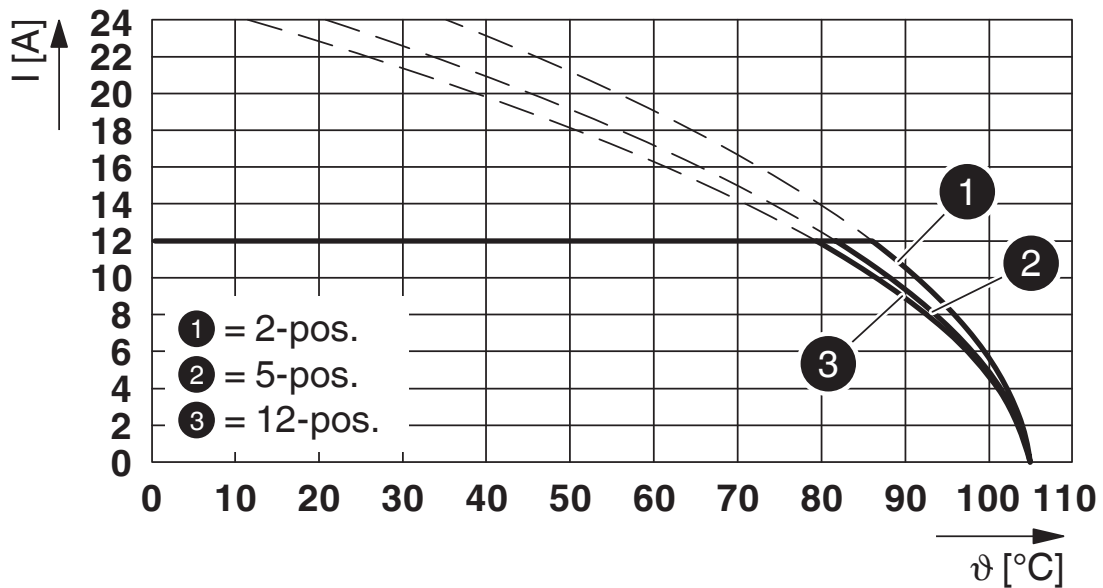

Type: GMSTB 2,5/...-ST-7,62 with GFKIC 2,5/...-ST-7,62

GMSTB 2,5/ 2-ST-7,62 - PCB connector



1766990

<https://www.phoenixcontact.com/us/products/1766990>

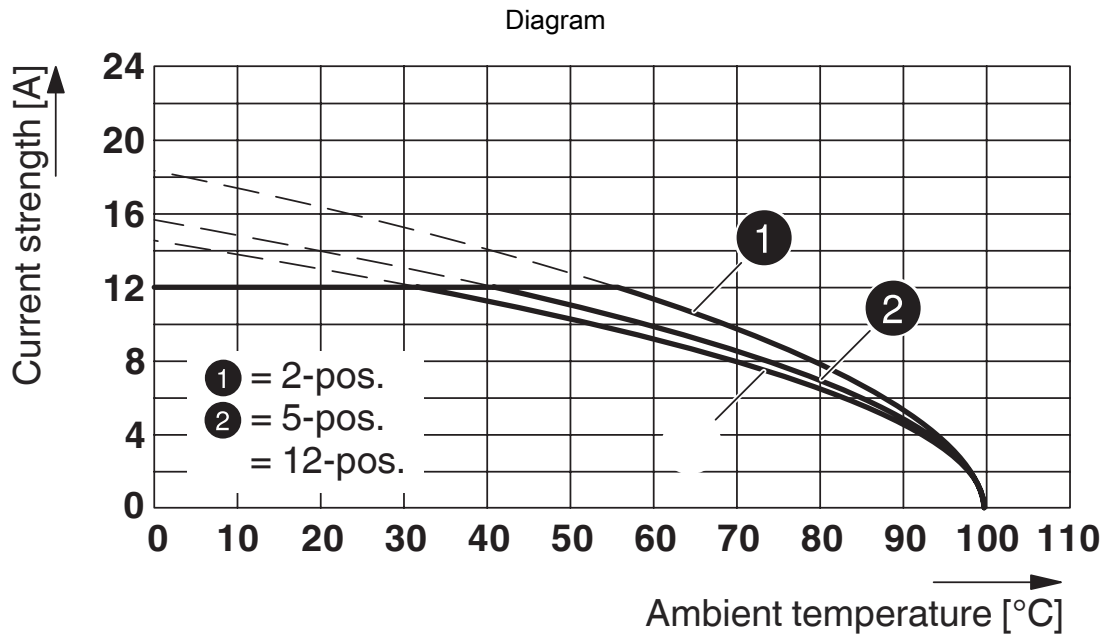

Type: GMSTB 2,5/...-ST-7,62 with GMSTBVA 2,5/...-G-7,62

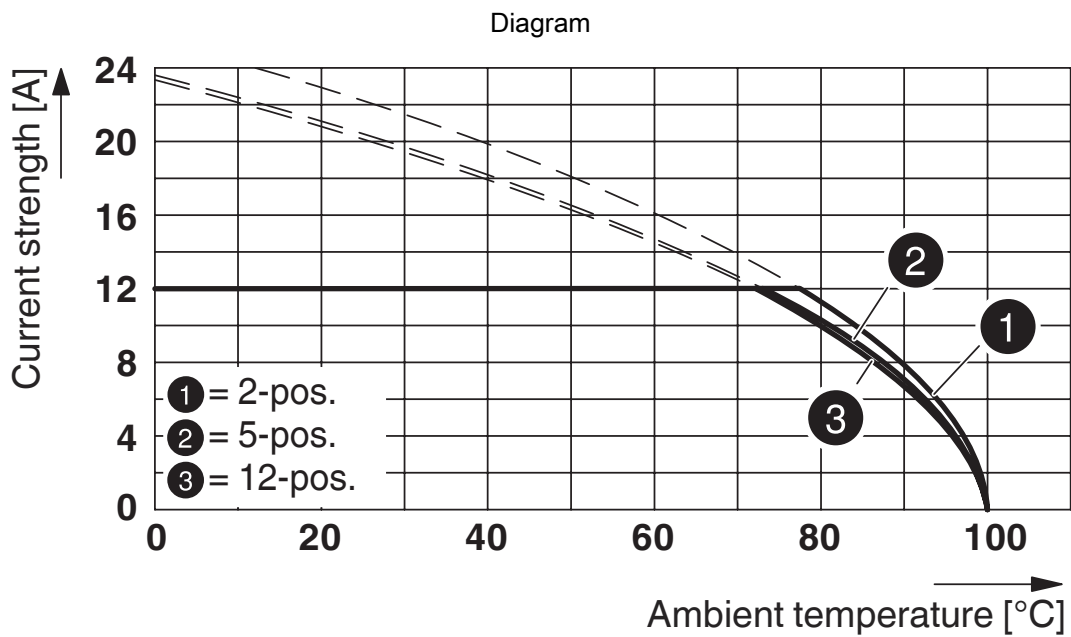

Type: GMSTB 2,5/...-ST-7,62 with GMSTBA 2,5/...-G-7,62

GMSTB 2,5/ 2-ST-7,62 - PCB connector



1766990

<https://www.phoenixcontact.com/us/products/1766990>

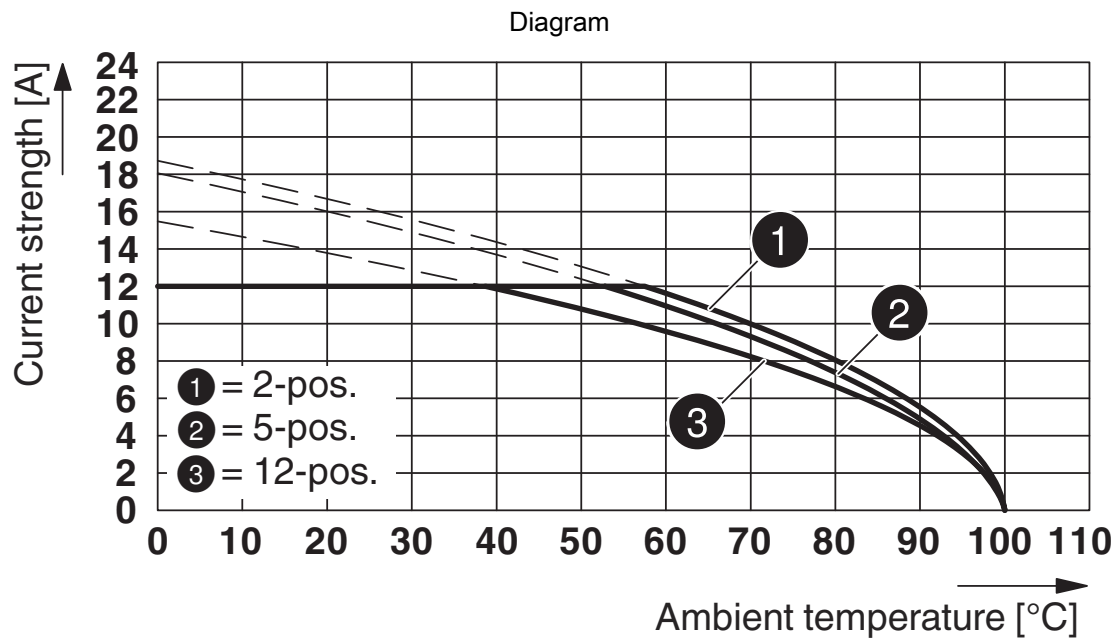

Type: GMSTB 2,5/...-ST-7,62 with GMSTBV 2,5/...-G-7,62

GMSTB 2,5/ 2-ST-7,62 - PCB connector





1766990

<https://www.phoenixcontact.com/us/products/1766990>

Approvals

To download certificates, visit the product detail page: <https://www.phoenixcontact.com/us/products/1766990>

|  CSA Approval ID: 13631 | | | | |
|--|-----------------------|-----------------------|-------------------|-----------------------------|
| | Nominal voltage U_N | Nominal current I_N | Cross section AWG | Cross section mm^2 |
| Use group B | | | | |
| | 300 V | 10 A | 28 - 12 | - |
| Use group D | | | | |
| | 300 V | 10 A | 28 - 12 | - |

|  cULus Recognized Approval ID: E60425-19931013 | | | | |
|---|-----------------------|-----------------------|-------------------|-----------------------------|
| | Nominal voltage U_N | Nominal current I_N | Cross section AWG | Cross section mm^2 |
| Use group B | | | | |
| | 300 V | 15 A | 30 - 12 | - |
| Use group D | | | | |
| | 300 V | 10 A | 30 - 12 | - |

|  VDE Zeichengenehmigung Approval ID: 40050646 | | | | |
|--|-----------------------|-----------------------|-------------------|-----------------------------|
| | Nominal voltage U_N | Nominal current I_N | Cross section AWG | Cross section mm^2 |
| | 400 V | 12 A | - | 0.2 - 2.5 |

GMSTB 2,5/ 2-ST-7,62 - PCB connector



1766990

<https://www.phoenixcontact.com/us/products/1766990>

Classifications

ECLASS

| | |
|-------------|----------|
| ECLASS-11.0 | 27460202 |
| ECLASS-12.0 | 27460202 |
| ECLASS-13.0 | 27460202 |

ETIM

| | |
|----------|----------|
| ETIM 8.0 | EC002638 |
|----------|----------|

UNSPSC

| | |
|-------------|----------|
| UNSPSC 21.0 | 39121400 |
|-------------|----------|

GMSTB 2,5/ 2-ST-7,62 - PCB connector



1766990

<https://www.phoenixcontact.com/us/products/1766990>

Environmental product compliance

| | |
|------------|---|
| China RoHS | Environmentally friendly use period: unlimited = EFUP-e |
| | No hazardous substances above threshold values |

GMSTB 2,5/ 2-ST-7,62 - PCB connector



1766990

<https://www.phoenixcontact.com/us/products/1766990>

Accessories

SZS 0,6X3,5 - Screwdriver

1205053

<https://www.phoenixcontact.com/us/products/1205053>



Actuation tool, for ST terminal blocks, insulated, also suitable for use as a bladed screwdriver, size: 0.6 x 3.5 x 100 mm, 2-component grip, with non-slip grip

CP-MSTB - Coding profile

1734634

<https://www.phoenixcontact.com/us/products/1734634>



Coding profile, is inserted into the slot on the plug or inverted header, red insulating material

GMSTB 2,5/ 2-ST-7,62 - PCB connector

1766990

<https://www.phoenixcontact.com/us/products/1766990>



SK 7,62/3,8:FORTL.ZAHLEN - Marker card

0804549

<https://www.phoenixcontact.com/us/products/0804549>

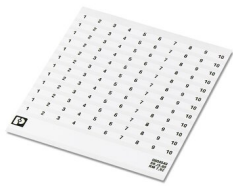

Marker card, white, labeled, horizontal: consecutive numbers 1 ... 10, 11 ... 20, etc. up to 91 ... 100, mounting type: adhesive, for terminal block width: 7.62 mm, lettering field size: 7.62 x 3.8 mm

B-STIFT - Marker pen

1051993

<https://www.phoenixcontact.com/us/products/1051993>



Marker pen, for manual labeling of unprinted Zack strips, smear-proof and waterproof, line thickness 0.5 mm

GMSTB 2,5/ 2-ST-7,62 - PCB connector



1766990

<https://www.phoenixcontact.com/us/products/1766990>

EB 2-CC 7,5 - Insertion bridge

1948048

<https://www.phoenixcontact.com/us/products/1948048>

Insertion bridge, pitch: 7.5 mm, number of positions: 2, length: 17 mm, color: gray



GMSTB 2,5/ 2-G-7,62 - PCB header

1766123

<https://www.phoenixcontact.com/us/products/1766123>



PCB headers, nominal cross section: 2.5 mm², color: green, nominal current: 12 A, rated voltage (III/2): 630 V, contact surface: Tin, contact connection type: Pin, number of potentials: 2, number of rows: 1, number of positions: 2, number of connections: 2, product range: GMSTB 2,5/..-G, pitch: 7.62 mm, mounting: Wave soldering, pin layout: Linear pinning, solder pin [P]: 3.2 mm, number of solder pins per potential: 1, plug-in system: COMBICON MSTB 2,5, Pin connector pattern alignment: Standard, locking: without, mounting: without, type of packaging: packed in cardboard

GMSTB 2,5/ 2-ST-7,62 - PCB connector

1766990

<https://www.phoenixcontact.com/us/products/1766990>

GMSTBA 2,5/ 2-G-7,62 - PCB header

1766233

<https://www.phoenixcontact.com/us/products/1766233>



PCB headers, nominal cross section: 2.5 mm², color: green, nominal current: 12 A, rated voltage (III/2): 630 V, contact surface: Tin, contact connection type: Pin, number of potentials: 2, number of rows: 1, number of positions: 2, number of connections: 2, product range: GMSTBA 2,5/..-G, pitch: 7.62 mm, mounting: Wave soldering, pin layout: Linear pinning, solder pin [P]: 3.2 mm, number of solder pins per potential: 1, plug-in system: COMBICON MSTB 2,5, Pin connector pattern alignment: Standard, locking: without, mounting: without, type of packaging: packed in cardboard

GMSTBV 2,5/ 2-G-7,62 - PCB header

1766563

<https://www.phoenixcontact.com/us/products/1766563>

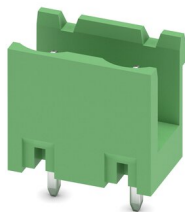

PCB headers, nominal cross section: 2.5 mm², color: green, nominal current: 12 A, rated voltage (III/2): 630 V, contact surface: Tin, contact connection type: Pin, number of potentials: 2, number of rows: 1, number of positions: 2, number of connections: 2, product range: GMSTBV 2,5/..-G, pitch: 7.62 mm, mounting: Wave soldering, pin layout: Linear pinning, solder pin [P]: 3.9 mm, number of solder pins per potential: 1, plug-in system: COMBICON MSTB 2,5, Pin connector pattern alignment: Standard, locking: without, mounting: without, type of packaging: packed in cardboard

GMSTB 2,5/ 2-ST-7,62 - PCB connector



1766990

<https://www.phoenixcontact.com/us/products/1766990>

GMSTBVA 2,5/ 2-G-7,62 - PCB header

1766770

<https://www.phoenixcontact.com/us/products/1766770>

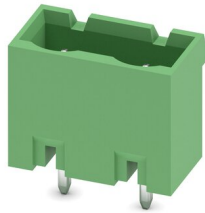

PCB headers, nominal cross section: 2.5 mm², color: green, nominal current: 12 A, rated voltage (III/2): 630 V, contact surface: Tin, contact connection type: Pin, number of potentials: 2, number of rows: 1, number of positions: 2, number of connections: 2, product range: GMSTBVA 2,5/..-G, pitch: 7.62 mm, mounting: Wave soldering, pin layout: Linear pinning, solder pin [P]: 3.9 mm, number of solder pins per potential: 1, plug-in system: COMBICON MSTB 2,5, Pin connector pattern alignment: Standard, locking: without, mounting: without, type of packaging: packed in cardboard

Phoenix Contact 2023 © - all rights reserved

<https://www.phoenixcontact.com>

Phoenix Contact USA
586 Fulling Mill Road
Middletown, PA 17057, United States
(+717) 944-1300
info@phoenixcon.com

单击下面可查看定价，库存，交付和生命周期等信息

[>>Phoenix Contact\(菲尼克斯\)](#)