



PJ79L05SQ

3-Terminal Negative Voltage Regulator

SOT-89

Features

- Maximum output current I_{OM} : 0.1A
- Output voltage V_O : -5V
- Continuous total dissipation P_D : 0.6W ($T_a = 25^\circ\text{C}$)

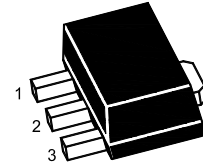

1. Ground 2. Input 3. Output

Absolute Maximum Ratings (operating temperature range applies unless otherwise specified)

Parameter	Symbol	Value	Units
Input Voltage	$-V_I$	30	V
Thermal Resistance from Junction-to-Ambient	$R_{\theta JA}$	208.3	$^\circ\text{C}/\text{W}$
Junction Temperature Range	T_J	150	$^\circ\text{C}$
Operating Temperature Range	T_{OPR}	-40 ~ 125	$^\circ\text{C}$
Storage Temperature Range	T_{STG}	-65 ~ 150	$^\circ\text{C}$

Electrical Characteristics

($-V_I=10\text{V}$, $I_O=40\text{mA}$, $C_i=0.33\mu\text{F}$, $C_o=0.1\mu\text{F}$, unless otherwise specified.)

Parameter	Symbol	Conditions	Min.	Typ.	Max.	Units
Output Voltage	$-V_o$	25°C	4.8	5	5.2	V
		$-7\text{V} \leq V_I \leq -20\text{V}$, $I_O=1\text{mA} \sim 40\text{mA}$	4.75	5	5.25	V
		$0 \sim 125^\circ\text{C}$, $I_O=1\text{mA} \sim 70\text{mA}$	4.75	5	5.25	V
Load Regulation	ΔV_o	$I_O=1\text{mA} \sim 100\text{mA}$, 25°C	--	20	60	mV
		$I_O=1\text{mA} \sim 40\text{mA}$, 25°C	--	10	30	mV
Line Regulation	ΔV_o	$-7\text{V} \leq V_I \leq -20\text{V}$, 25°C	--	15	150	mV
		$-8\text{V} \leq V_I \leq -20\text{V}$, 25°C	--	12	100	mV
Quiescent Current	I_q	25°C	--	--	6	mA
Quiescent Current Change	ΔI_q	$-8\text{V} \leq V_I \leq -20\text{V}$, $0 \sim 125^\circ\text{C}$	--	--	1.5	mA
		$1\text{mA} \leq I_O \leq 40\text{mA}$, $0 \sim 125^\circ\text{C}$	--	--	0.1	mA
Output Noise Voltage	V_N	$10\text{Hz} \leq f \leq 100\text{KHz}$, 25°C	--	40	--	$\mu\text{V}/V_o$
Ripple Rejection	RR	$-8\text{V} \leq V_I \leq -18\text{V}$, $f=120\text{Hz}$, $0 \sim 125^\circ\text{C}$	41	49	--	dB
Dropout Voltage	V_d	25°C	--	1.7	--	V

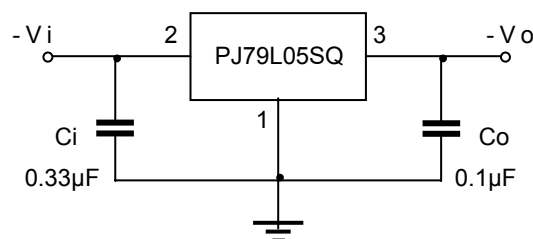



PJ79L05SQ

3-Terminal Negative Voltage Regulator

Electrical Characteristics Curves

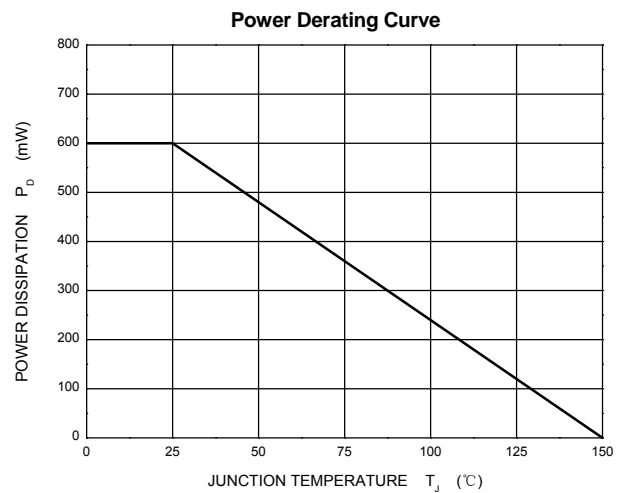
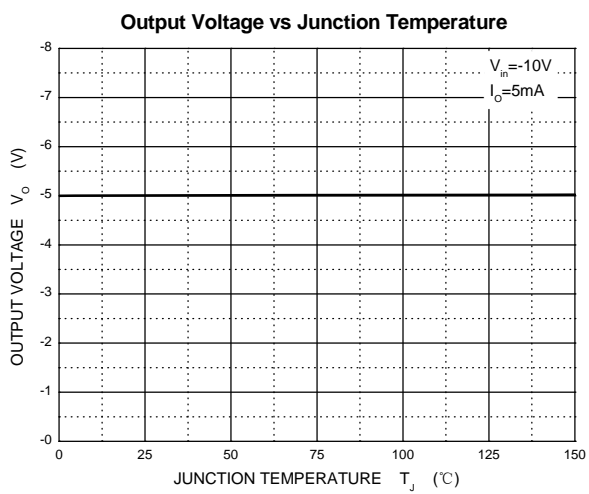
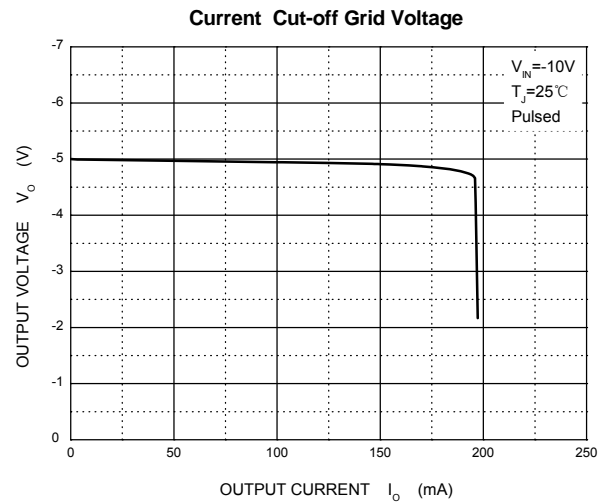
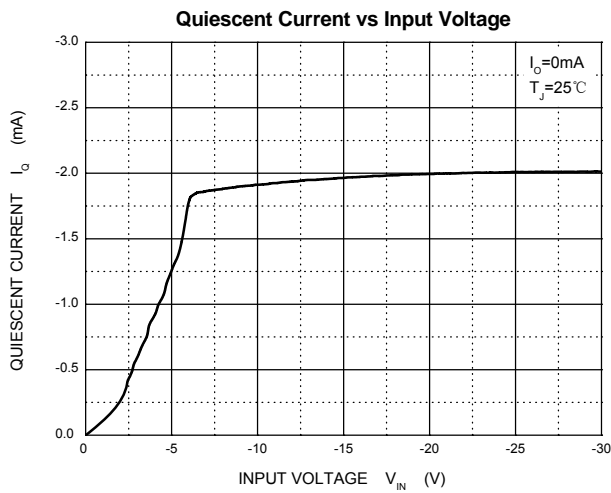
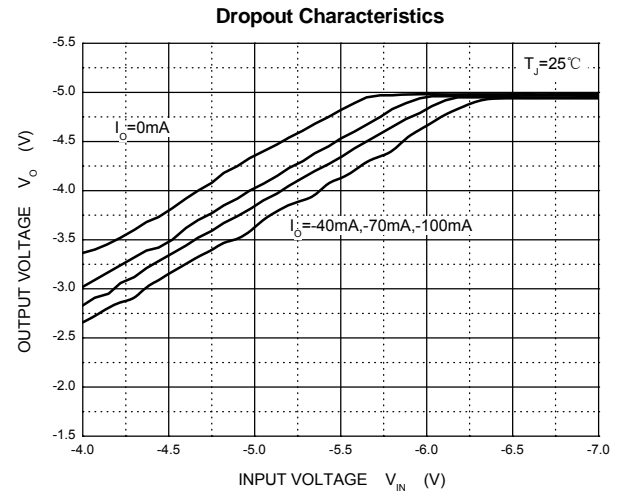
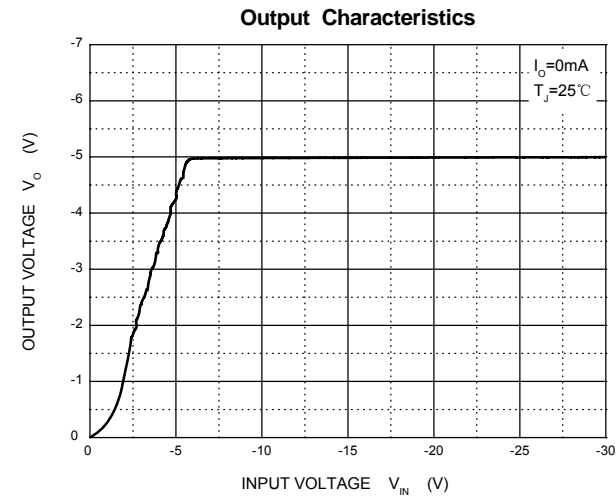



PJ79L05SQ

3-Terminal Negative Voltage Regulator

Package Outline SOT-89

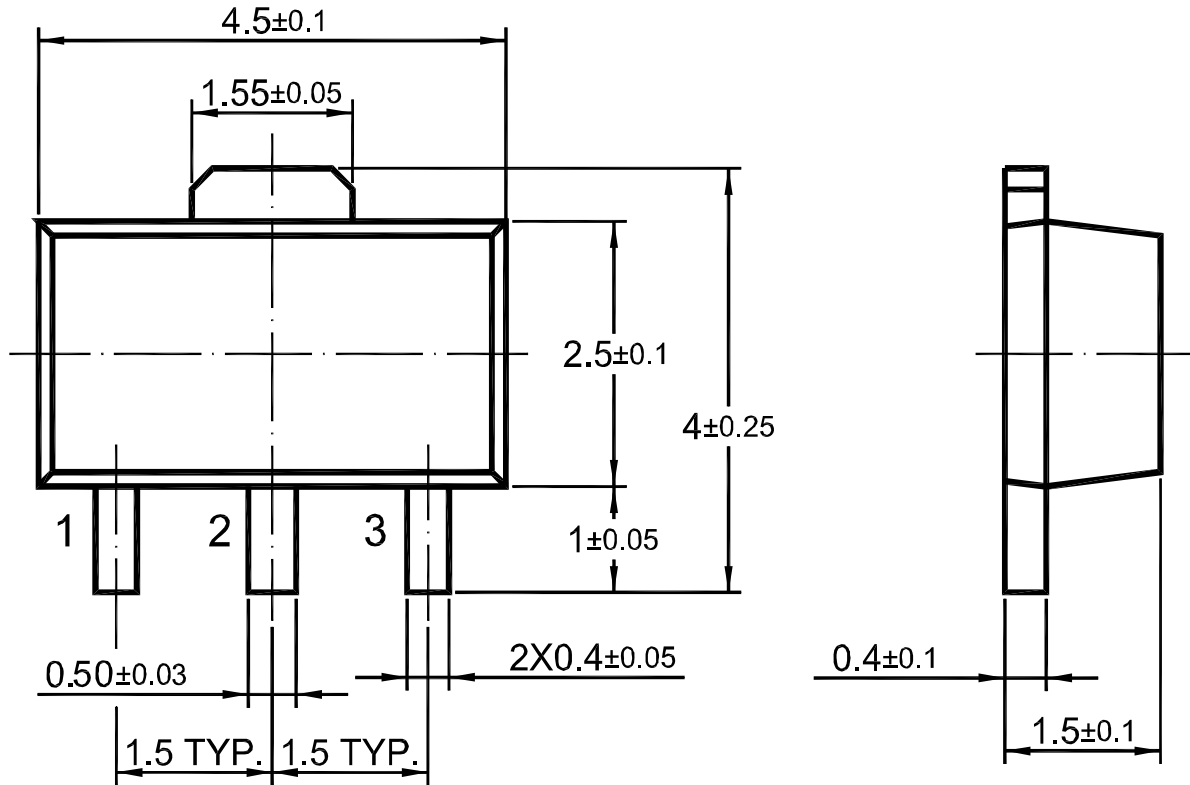

Ordering Information

Device	Package	Shipping
PJ79L05SQ	SOT-89	1,000PCS/T&R (7 inch)



PJ79L05SQ

3-Terminal Negative Voltage Regulator

Package Specifications unit: mm

◆ The method of packaging

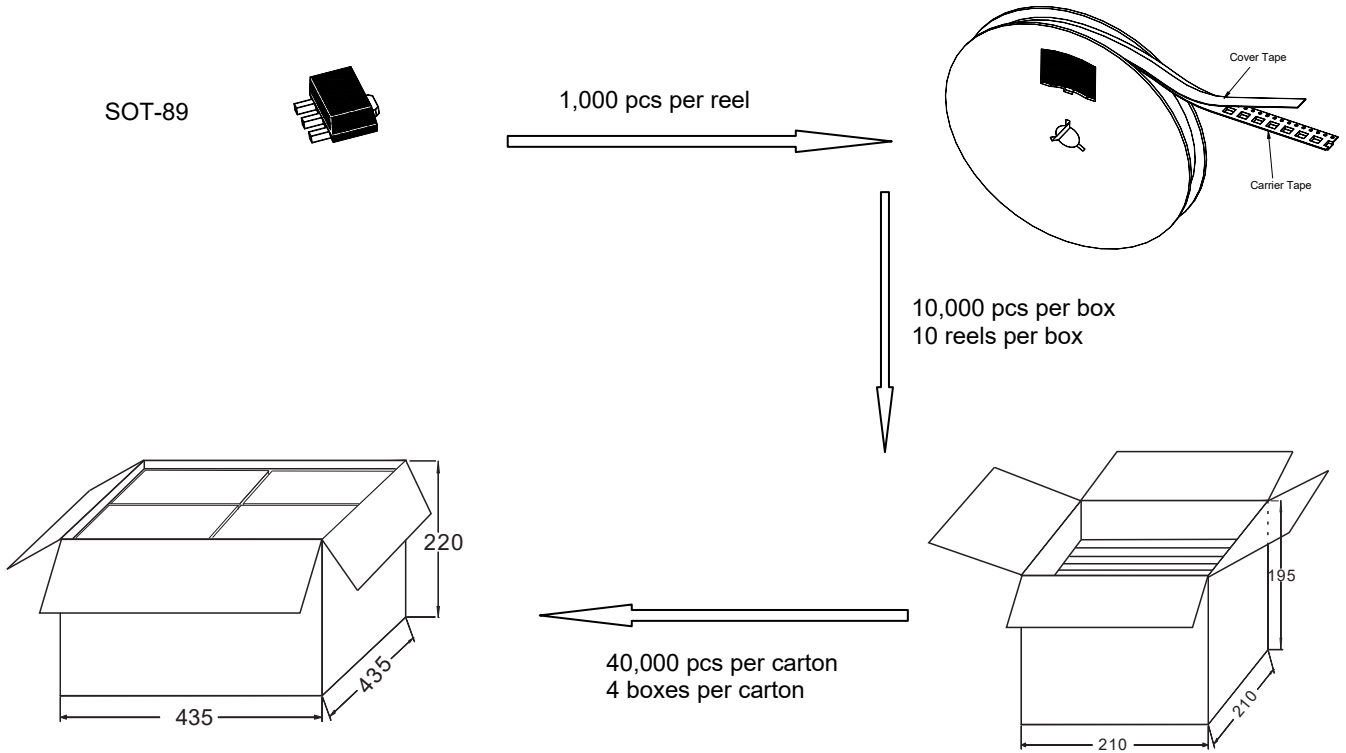

◆ Embossed tape and reel data

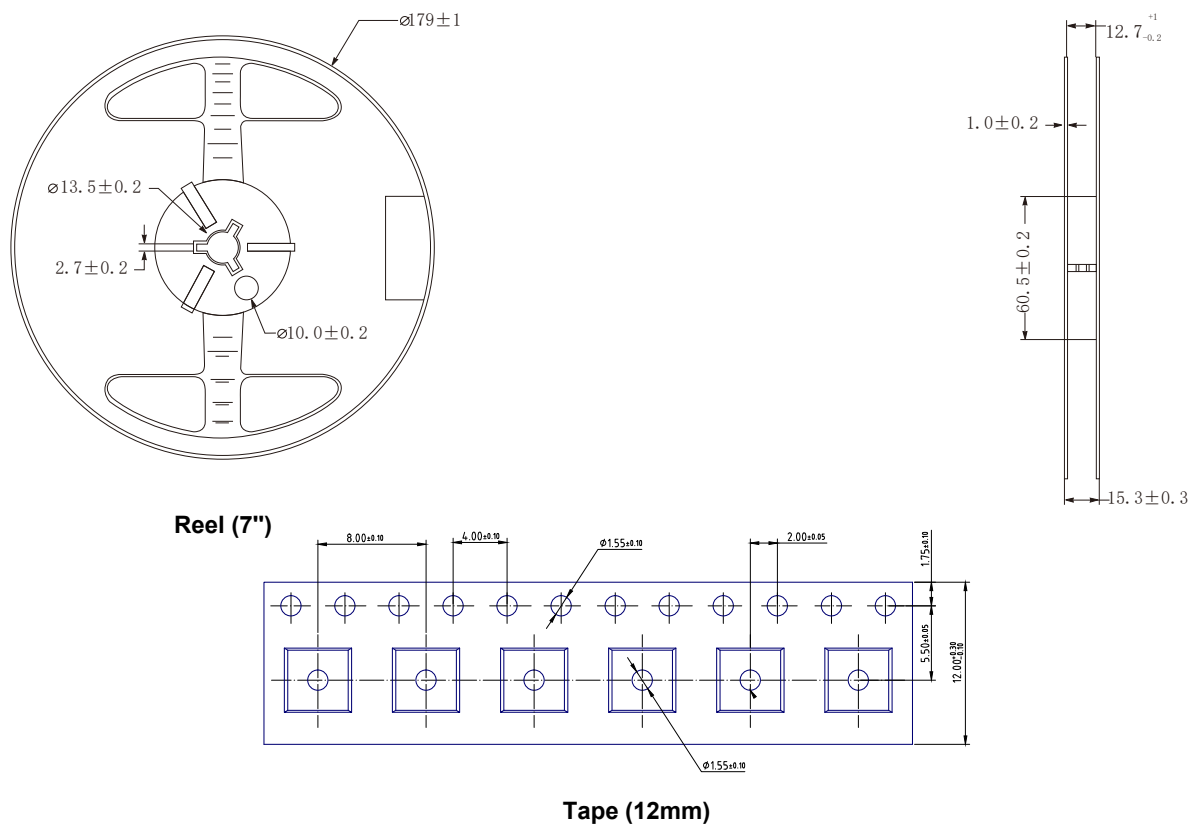

单击下面可查看定价，库存，交付和生命周期等信息

[>>PJSEMI\(平晶微\)](#)