



MMBT4401 NPN Transistor

Features

- For Switching and AF Amplifier Applications.
- Silicon Epitaxial Chip.

**SOT-23
(TO-236)**

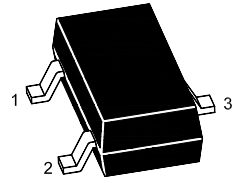

1.Base 2.Emitter 3.Collector

Absolute Maximum Ratings ($T_A = 25^\circ\text{C}$)

Parameter	Symbol	Value	Unit
Collector Base Voltage	V_{CB0}	60	V
Collector Emitter Voltage	V_{CEO}	40	V
Emitter Base Voltage	V_{EB0}	6	V
Collector Current	I_C	600	mA
Power Dissipation ¹	P_D	300	mW
Thermal Resistance Junction to Ambient	$R_{\theta JA}$	417	$^\circ\text{C/W}$
Junction Temperature	T_J	150	$^\circ\text{C}$
Storage Temperature Range	T_{STG}	- 55 to + 150	$^\circ\text{C}$

Note: On FR-5 board



Electrical Characteristics at $T_A = 25^\circ\text{C}$

Parameter	Symbol	Min.	Max.	Unit
DC Current Gain				
at $V_{CE} = 1\text{ V}$, $I_C = 0.1\text{ mA}$	h_{FE}	20	-	-
at $V_{CE} = 1\text{ V}$, $I_C = 1\text{ mA}$	h_{FE}	40	-	-
at $V_{CE} = 1\text{ V}$, $I_C = 10\text{ mA}$	h_{FE}	80	-	-
at $V_{CE} = 1\text{ V}$, $I_C = 150\text{ mA}$	h_{FE}	100	300	-
at $V_{CE} = 2\text{ V}$, $I_C = 500\text{ mA}$	h_{FE}	40	-	-
Collector Base Cutoff Current at $V_{CB} = 35\text{ V}$	I_{CBO}	-	0.1	μA
Emitter Base Cutoff Current at $V_{EB} = 5\text{ V}$	I_{EBO}	-	0.1	μA
Collector Base Breakdown Voltage at $I_C = 0.1\text{ mA}$	$V_{(BR)CBO}$	60	-	V
Collector Emitter Breakdown Voltage at $I_C = 1\text{ mA}$	$V_{(BR)CEO}$	40	-	V
Emitter Base Breakdown Voltage at $I_E = 0.1\text{ mA}$	$V_{(BR)EBO}$	6	-	V
Collector Emitter Saturation Voltage at $I_C = 10\text{ mA}$, $I_B = 1\text{ mA}$	$V_{CE(sat)}$	-	0.4	V
at $I_C = 50\text{ mA}$, $I_B = 5\text{ mA}$	$V_{CE(sat)}$	-	0.75	V
Base Emitter Saturation Voltage at $I_C = 150\text{ mA}$, $I_B = 15\text{ mA}$	$V_{BE(sat)}$	0.75	0.95	V
at $I_C = 500\text{ mA}$, $I_B = 50\text{ mA}$	$V_{BE(sat)}$	-	1.2	V
Current Gain Bandwidth Product at $V_{CE} = 10\text{ V}$, $I_C = 20\text{ mA}$, $f = 100\text{ MHz}$	f_T	250	-	MHz
Collector Output Capacitance at $V_{CB} = 5\text{ V}$, $f = 1\text{ MHz}$	C_{ob}	-	6.5	pF
Delay Time at $V_{CC} = 30\text{ V}$, $V_{BE} = 2\text{ V}$, $I_C = 150\text{ mA}$, $I_{B1} = 15\text{ mA}$	t_d	-	15	ns
Rise Time at $V_{CC} = 30\text{ V}$, $V_{BE} = 2\text{ V}$, $I_C = 150\text{ mA}$, $I_{B1} = 15\text{ mA}$	t_r	-	20	ns
Storage Time at $V_{CC} = 30\text{ V}$, $I_C = 150\text{ mA}$, $I_{B1} = I_{B2} = 15\text{ mA}$	t_s	-	225	ns
Fall Time at $V_{CC} = 30\text{ V}$, $I_C = 150\text{ mA}$, $I_{B1} = I_{B2} = 15\text{ mA}$	t_f	-	30	ns



Electrical Characteristics Curves

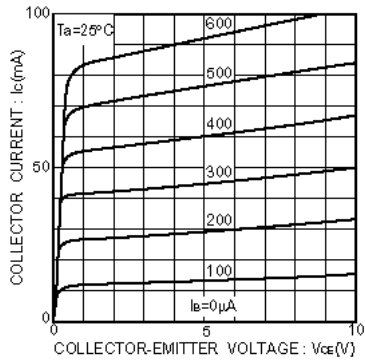

Fig.1 Grounded emitter output characteristics

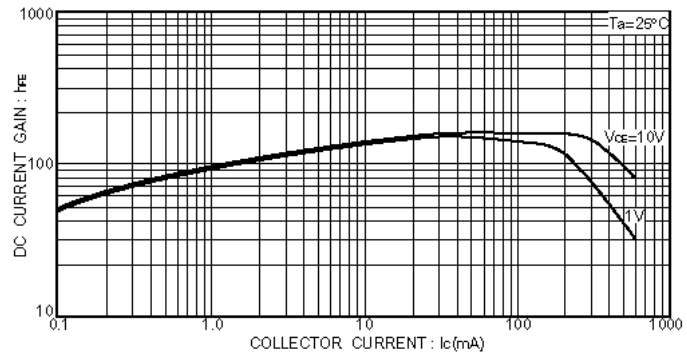

Fig.3 DC current gain vs. collector current(I)

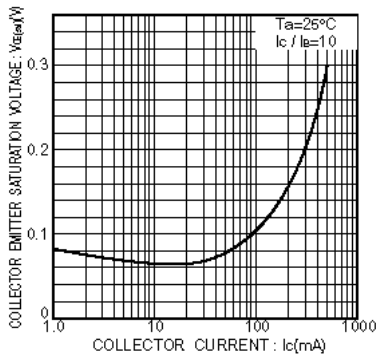

Fig.2 Collector-emitter saturation voltage vs. collector current

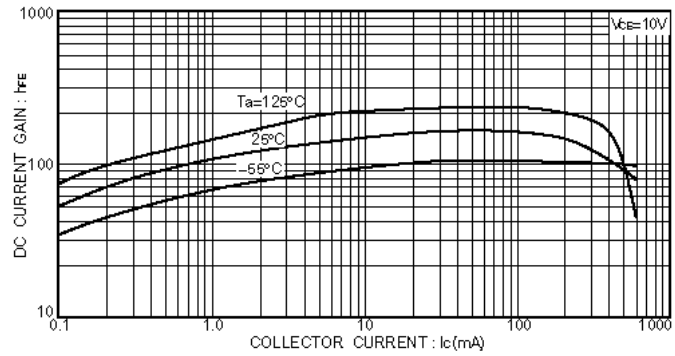

Fig.4 DC current gain vs. collector current(II)

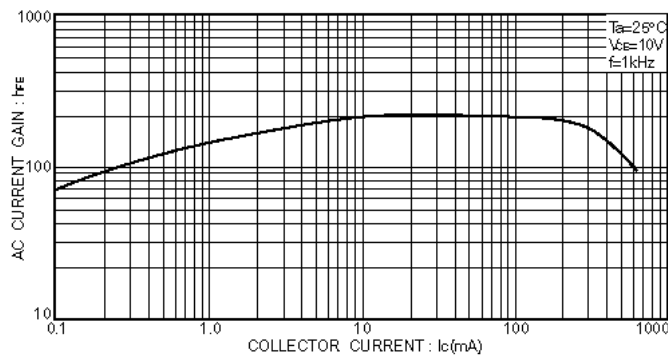

Fig.5 AC current gain vs. collector current

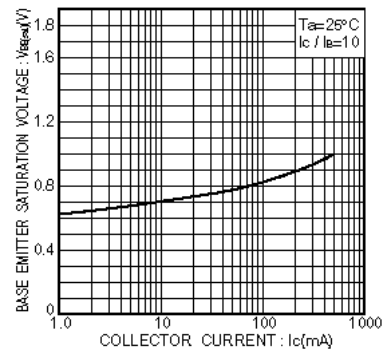
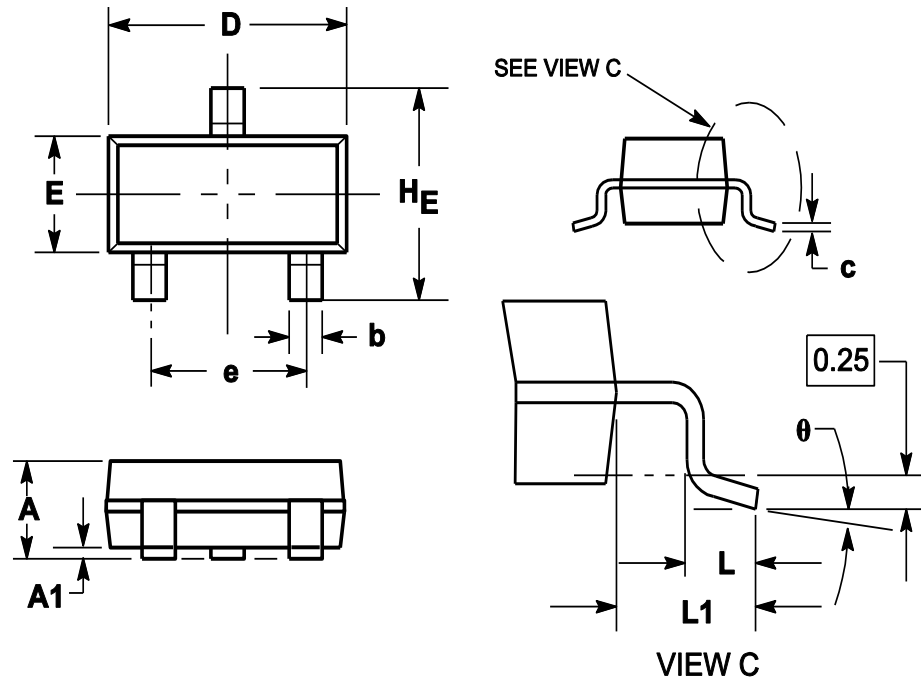

Fig.6 Base-emitter saturation voltage vs. collector current



Package Outline (SOT-23)



Symbol	Dimensions in millimeter		
	Min.	Typ.	Max.
A	0.900	1.025	1.150
A1	0.000	0.050	0.100
b	0.300	0.400	0.500
c	0.080	0.115	0.150
D	2.800	2.900	3.000
E	1.200	1.300	1.400
HE	2.250	2.400	2.550
e	1.800	1.900	2.000
L1	0.550REF		
L	0.300		0.500
θ	0°		8°

Ordering Information

Device	Package	Reel Dimension (inch)	Shipping Quantity
MMBT4401	SOT-23	7	3,000

单击下面可查看定价，库存，交付和生命周期等信息

[>>PJSEMI\(平晶微\)](#)