



# MMBT8050-1.5A

## NPN Transistor

### Features

- For Switching and Amplifier Applications.
- Especially Suitable for AF-Driver Stages and Low Power Output Stages.

SOT-23  
(TO-236)

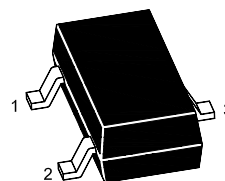

1.Base 2.Emitter 3.Collector

Marking: -C: X1

-D: Y1

### Absolute Maximum Ratings

Ratings at 25°C ambient temperature unless otherwise specified.

Parameter	Symbol	Value	Unit
Collector Base Voltage	$V_{CB0}$	40	V
Collector Emitter Voltage	$V_{CE0}$	25	V
Emitter Base Voltage	$V_{EB0}$	6	V
Collector Current	$I_C$	1.5	A
Power Dissipation	$P_D$	350	mW
Junction Temperature	$T_J$	150	°C
Storage Temperature Range	$T_{STG}$	-55 to 150	°C

### Electrical Characteristics

Ratings at 25°C ambient temperature unless otherwise specified.

Parameter	Symbol	Min.	Typ.	Max.	Unit
DC Current Gain at $V_{CE} = 1$ V, $I_C = 100$ mA Current Gain Group C D	$H_{FE}$	100	-	250	
		160	-	400	
		at $V_{CE} = 1$ V, $I_C = 800$ mA	40	-	
Collector Base Cutoff Current at $V_{CB} = 35$ V	$I_{CB0}$	-	-	100	nA
Emitter Base Cutoff Current at $V_{CB} = 6$ V	$I_{EB0}$	-	-	100	nA
Collector Base Breakdown Voltage at $I_C = 100$ $\mu$ A	$V_{(BR)CB0}$	40	-	-	V
Collector Emitter Breakdown Voltage at $I_C = 2$ mA	$V_{(BR)CEO}$	25	-	-	V
Emitter Base Breakdown Voltage at $I_E = 100$ $\mu$ A	$V_{(BR)EBO}$	6	-	-	V
Collector Emitter Saturation Voltage at $I_C = 800$ mA, $I_B = 80$ mA	$V_{CE(sat)}$	-	-	0.5	V
Base Emitter Saturation Voltage at $I_C = 800$ mA, $I_C = 80$ mA	$V_{BE(sat)}$	-	-	1.2	V
Base Emitter Voltage at $V_{CE} = 1$ V, $I_B = 10$ mA	$V_{BE(on)}$	-	-	1	V
Transition Frequency at $V_{CE} = 10$ V, $I_C = 50$ mA	$F_T$	120	-	-	MHz



### Electrical Characteristics Curves

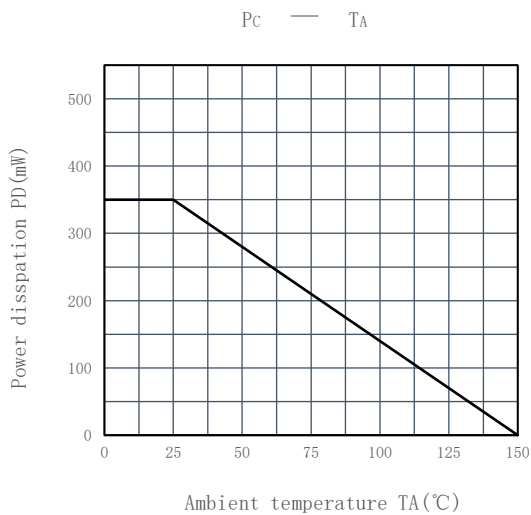
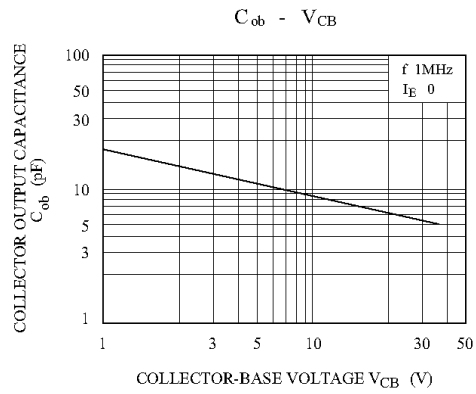
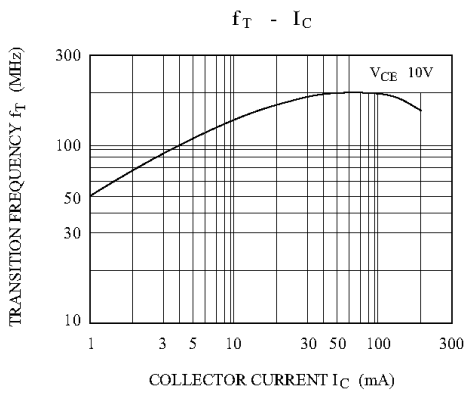
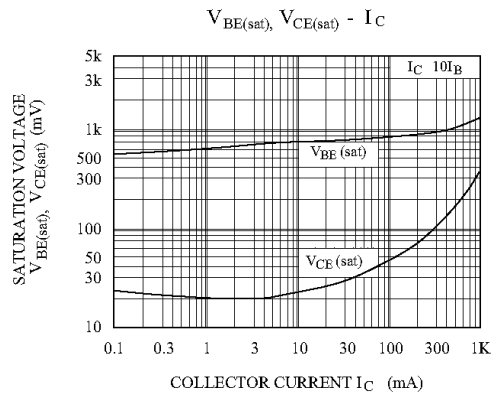
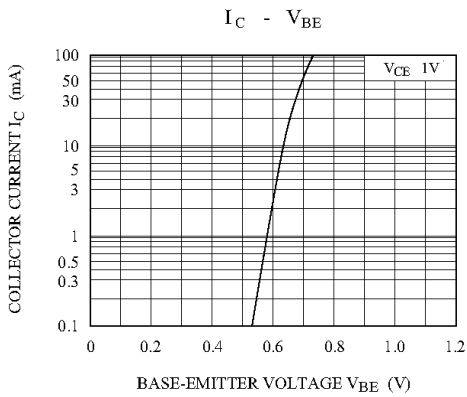
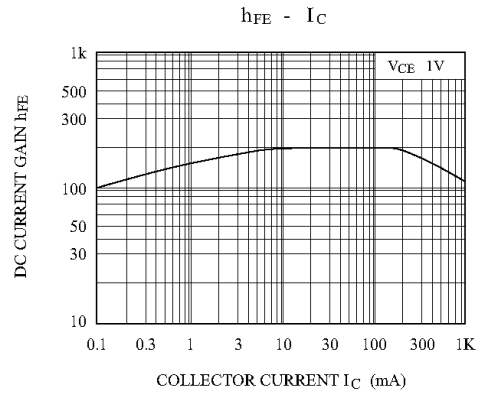
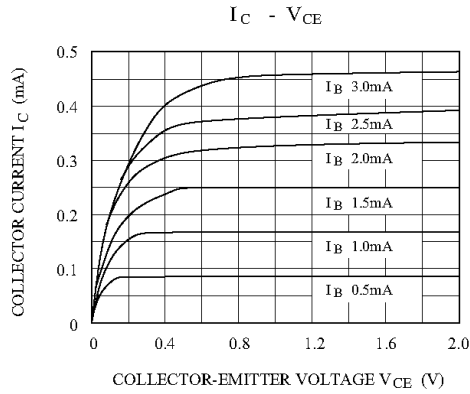



**Package Outline(SOT-23)**

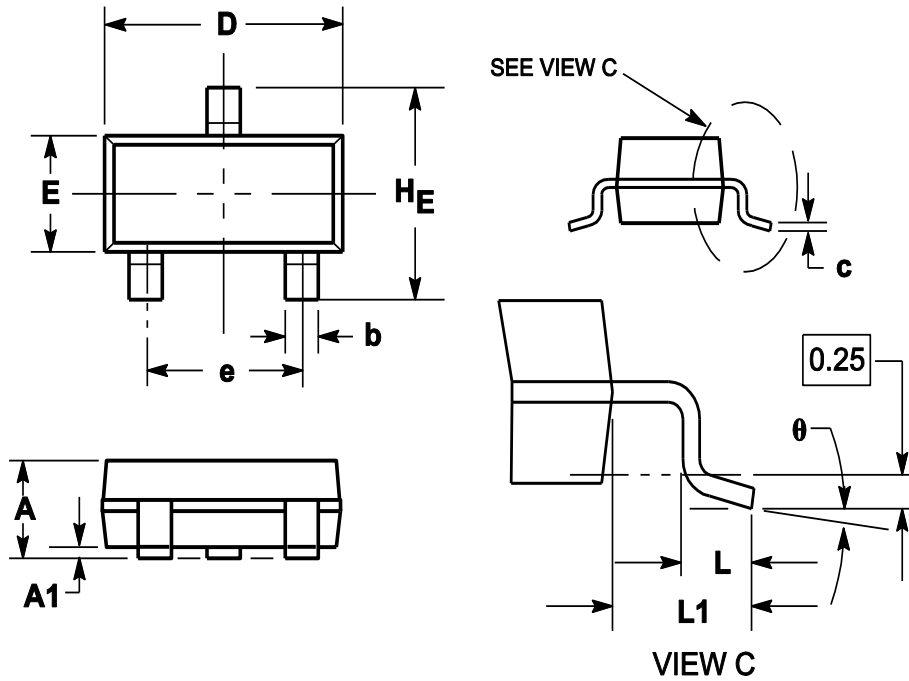

Symbol	Dimensions in millimeter		
	Min.	Typ.	Max.
A	0.900	1.025	1.150
A1	0.000	0.050	0.100
b	0.300	0.400	0.500
c	0.080	0.115	0.150
D	2.800	2.900	3.000
E	1.200	1.300	1.400
HE	2.250	2.400	2.550
e	1.800	1.900	2.000
L1	0.550REF		
L	0.300		0.500
$\theta$	0°		8°

**Ordering Information**

Device	Package	Reel Dimension (inch)	Shipping
MMBT8050-1.5A	SOT-23	7	3,000

单击下面可查看定价，库存，交付和生命周期等信息

[>>PJSEMI\(平晶微\)](#)