



PJM2302NSC

N-Channel Enhancement Mode Power MOSFET

Features

- Fast switching
- Low gate charge and $R_{DS(on)}$
- High power and current handling capability
- $V_{DS} = 20V, I_D = 4A$
 $R_{DS(on)} < 40m\Omega @ V_{GS} = 4.5V$

Application

- Power switching application
- Power management

SOT-23-3

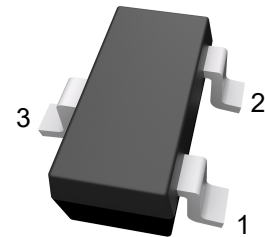

1. Gate 2. Source 3. Drain

Marking Code: Q2

Schematic Diagram

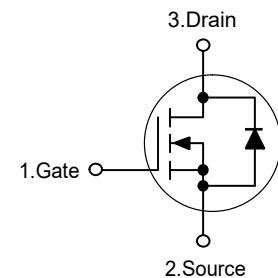

Absolute Maximum Ratings

Ratings at 25°C ambient temperature unless otherwise specified.

Parameter	Symbol	Value	Unit
Drain-Source Voltage	V_{DS}	20	V
Gate-Source Voltage	V_{GS}	± 12	V
Drain Current-Continuous	I_D	4	A
Drain Current-Pulsed ^{Note1}	I_{DM}	20	A
Maximum Power Dissipation	P_D	1.25	W
Junction Temperature	T_J	150	°C
Storage Temperature Range	T_{STG}	-55 to +150	°C

Thermal Characteristics

Thermal Resistance, Junction-to-Ambient ^{Note2}	$R_{\theta JA}$	100	°C/W
--	-----------------	-----	------



PJM2302NSC

N-Channel Enhancement Mode Power MOSFET

Electrical Characteristics

(Ta=25°C unless otherwise specified)

Parameter	Symbol	Test Condition	Min.	Typ.	Max.	Unit
Static Characteristics						
Drain-Source Breakdown Voltage	$V_{(BR)DSS}$	$V_{GS}=0V, I_D=250\mu A$	20	--	--	V
Zero Gate Voltage Drain Current	I_{DSS}	$V_{DS}=20V, V_{GS}=0V$	--	--	1	μA
Gate-Body Leakage Current	I_{GSS}	$V_{GS}=\pm 12V, V_{DS}=0V$	--	--	± 100	nA
Gate Threshold Voltage ^{Note3}	$V_{GS(th)}$	$V_{DS}=V_{GS}, I_D=250\mu A$	0.5	0.8	1.2	V
Drain-Source On-Resistance ^{Note3}	$R_{DS(on)}$	$V_{GS}=4.5V, I_D=3A$	--	23	40	m Ω
		$V_{GS}=2.5V, I_D=2.8A$	--	30	55	m Ω
Forward Transconductance ^{Note3}	g_{FS}	$V_{DS}=5V, I_D=1A$	--	5	--	S
Dynamic Characteristics						
Input Capacitance	C_{iss}	$V_{DS}=10V, V_{GS}=0V, f=1MHz$	--	300	--	pF
Output Capacitance	C_{oss}		--	120	--	pF
Reverse Transfer Capacitance	C_{rss}		--	80	--	pF
Switching Characteristics						
Turn-on Delay Time	$t_{d(on)}$	$V_{DD}=10V, I_D=3A$ $V_{GS}=4.5V, R_{GEN}=6\Omega$	--	10	--	nS
Turn-on Rise Time	t_r		--	50	--	nS
Turn-off Delay Time	$t_{d(off)}$		--	17	--	nS
Turn-off Fall Time	t_f		--	10	--	nS
Total Gate Charge	Q_g	$V_{DS}=10V, I_D=3A, V_{GS}=4.5V$	--	4	--	nC
Gate-Source Charge	Q_{gs}		--	0.7	--	nC
Gate-Drain Charge	Q_{gd}		--	1.5	--	nC
Source-Drain Diode Characteristics						
Diode Forward Voltage ^{Note3}	V_{SD}	$V_{GS}=0V, I_S=4A$	--	0.75	1.2	V
Diode Forward Current ^{Note2}	I_S		--	--	4	A

- Note: 1. Repetitive Rating: Pulse width limited by maximum junction temperature.
 2. Surface Mounted on FR4 Board, $t \leq 10$ sec.
 3. Pulse Test: Pulse width $\leq 300\mu s$, duty cycle $\leq 2\%$.



Typical Characteristic Curves

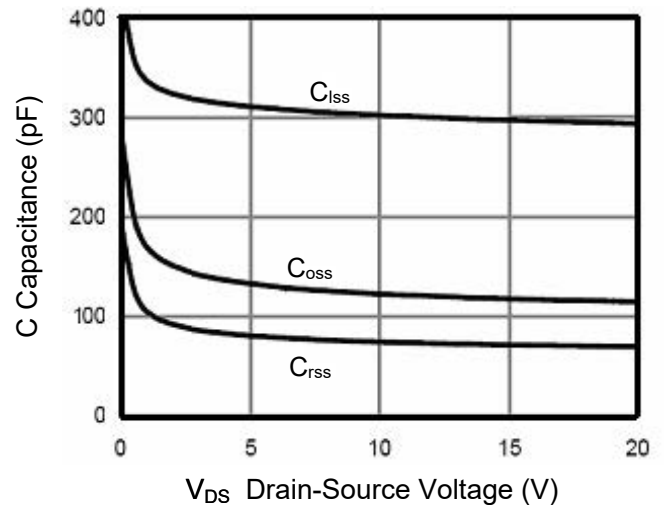
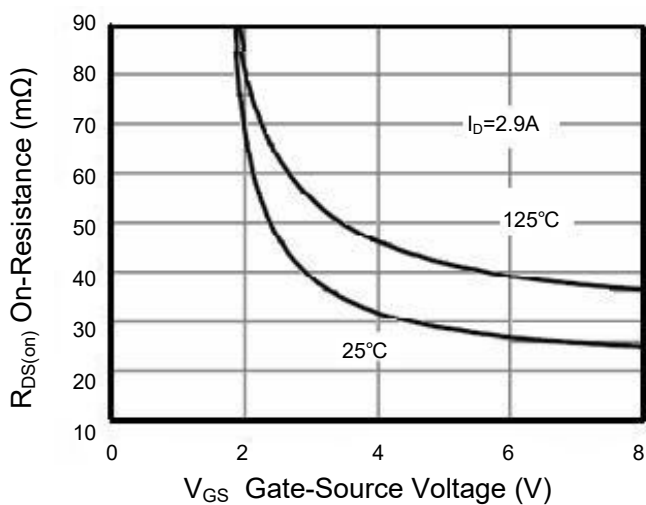
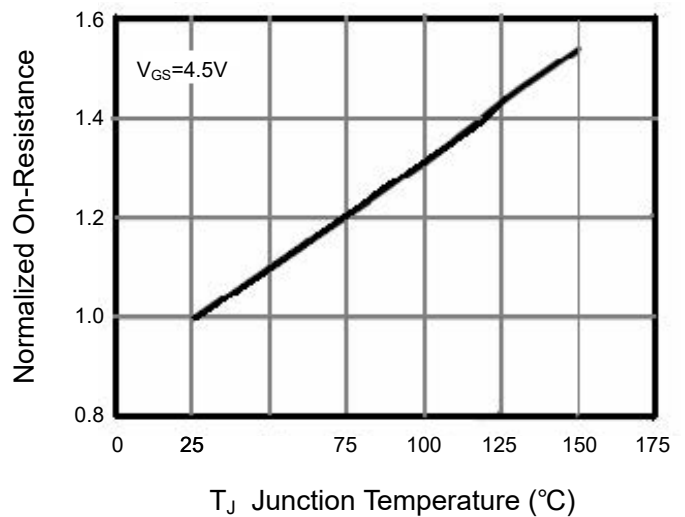
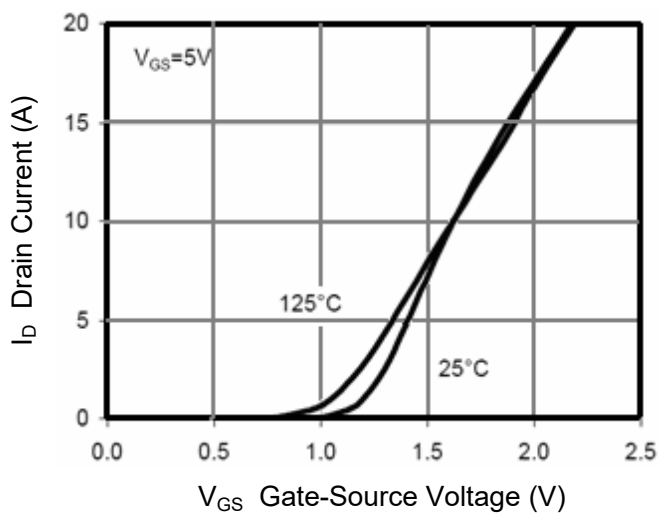
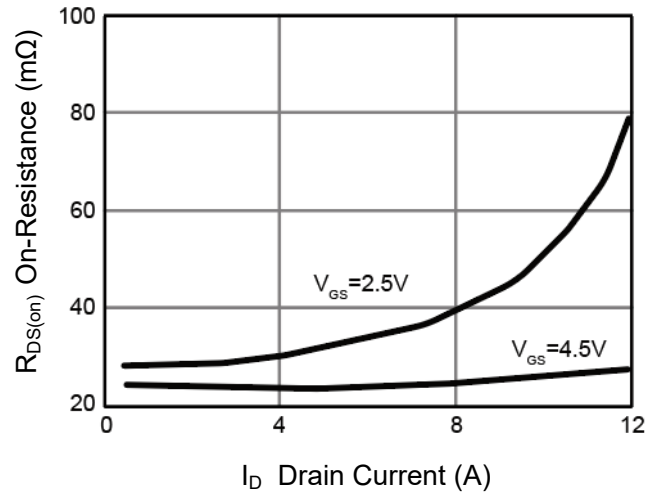
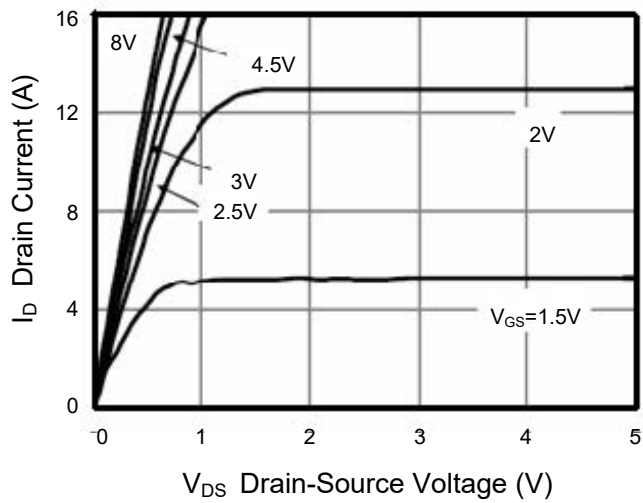



PJM2302NSC

N-Channel Enhancement Mode Power MOSFET

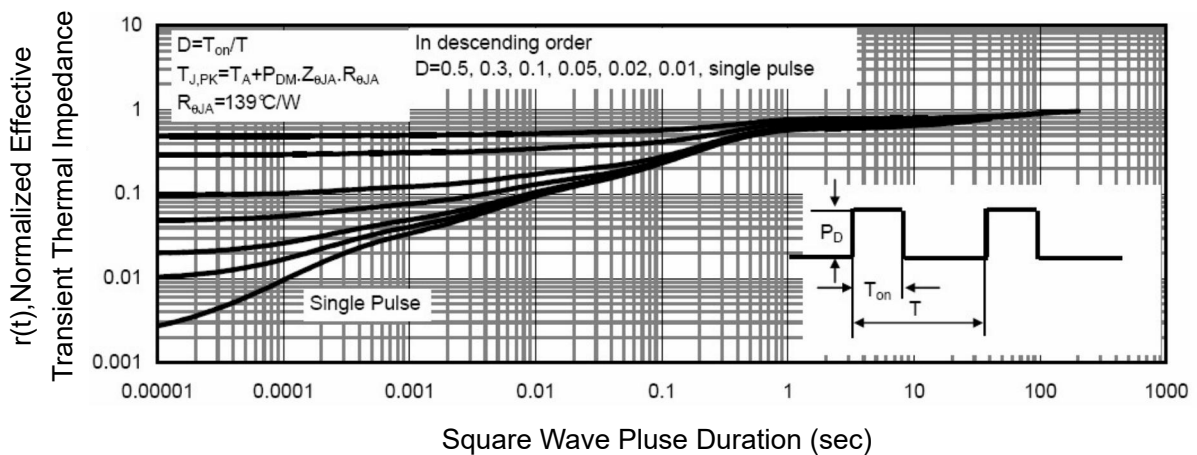
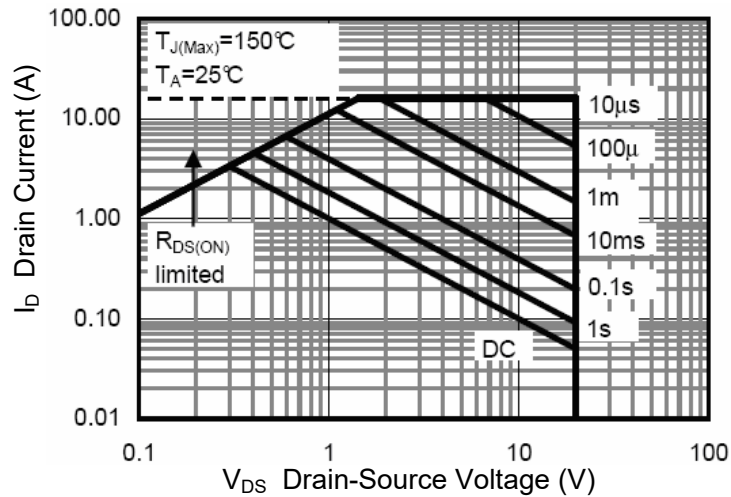
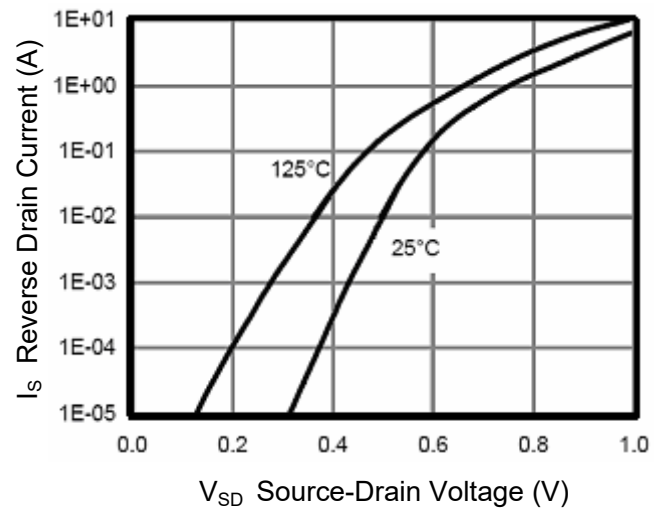
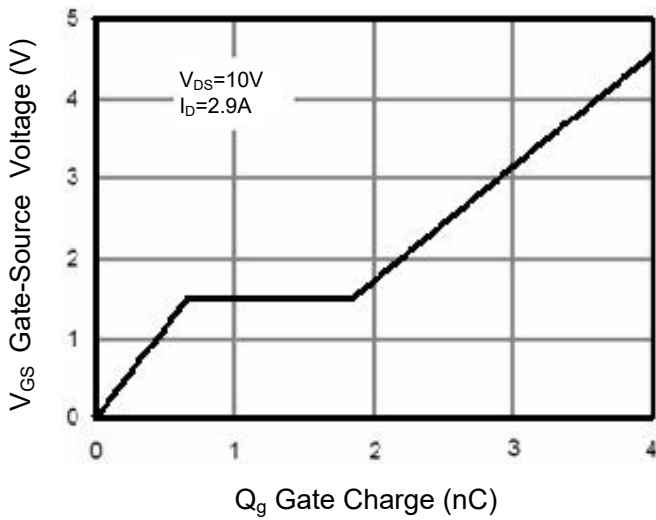



PJM2302NSC

N-Channel Enhancement Mode Power MOSFET

Package Outline

SOT-23-3

Dimensions in mm

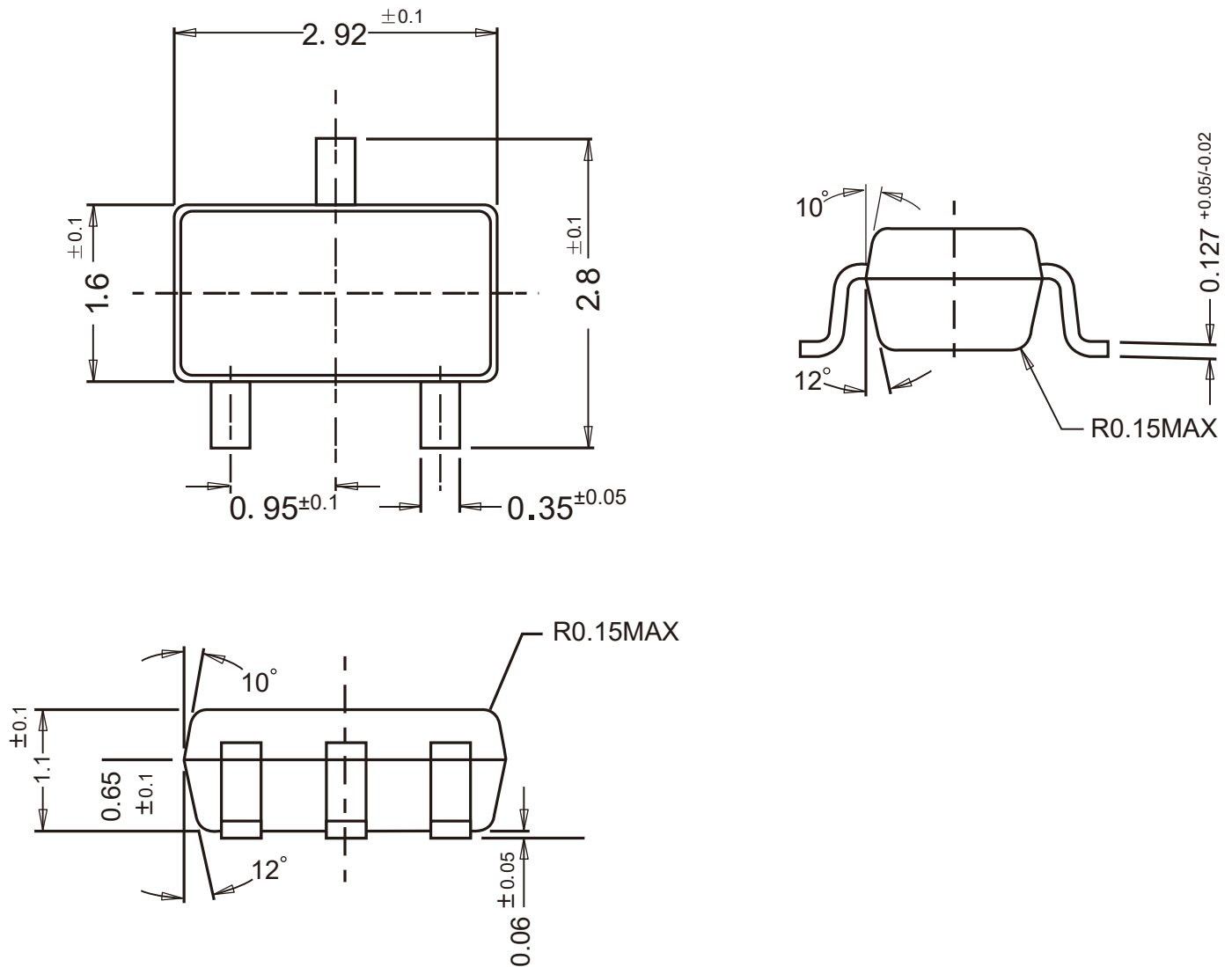

Ordering Information

Device	Package	Shipping
PJM2302NSC	SOT-23-3	3,000PCS/Reel&7inches



Conditions of Soldering and Storage

◆ Recommended condition of reflow soldering

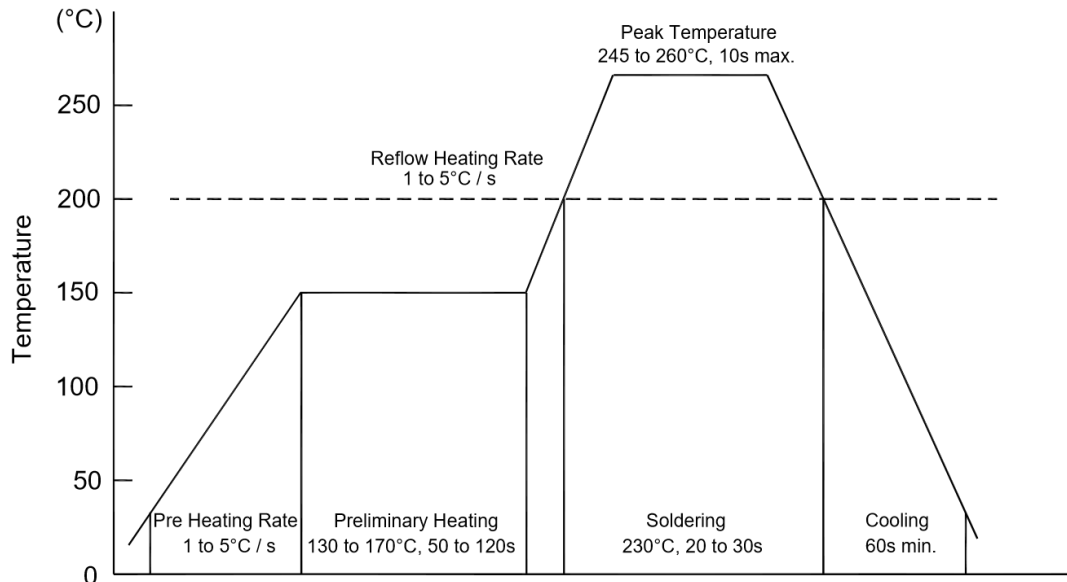

Recommended peak temperature is over 245 °C. If peak temperature is below 245 °C, you may adjust the following parameters:

- Time length of peak temperature (longer)
- Time length of soldering (longer)
- Thickness of solder paste (thicker)

◆ Conditions of hand soldering

- Temperature: 370 °C
- Time: 3s max.
- Times: one time

◆ Storage conditions

- **Temperature**
5 to 40 °C
- **Humidity**
30 to 80% RH
- **Recommended period**
One year after manufacturing

单击下面可查看定价，库存，交付和生命周期等信息

[>>PJSEMI\(平晶微\)](#)