

- ⊕ **Current Rating:** Over 90A_{pk}
- ⊕ **Inductance Range:** 90nH to 150nH
- ⊕ **Height:** 10.0mm Max
- ⊕ **Footprint:** 6.5mm x 6.5mm Max

Electrical Specifications @ 25°C — Operating Temperature - 40°C to +130°C⁷

Part Number	Inductance ¹ @ 0A _{DC} (nH +/- 15%)	Inductance ² @ I _{rated} (nH TYP)	I _{rated} ³ (ADC)	DCR ⁴ (mΩ nominal)	Saturation Current ⁵ (A TYP)		Heating Current ⁶ (A TYP)
					25°C	100°C	
PGL6312.900HLT	90	90	68	0.17 +/- 10%	90	77	70
PGL6312.101HLT	100	68	68		80	70	
PGL6312.121HLT	120	82	82		69	60	
PGL6312.151HLT	150	102	52		52	46	

NOTES:

- Inductance measured at 100kHz, 100mVrms.
- Inductance at I_{rated} is the value of the inductance at 25°C at the listed rated current.
- The rated current as listed is either the saturation current (25°C or 100°C) or the heating current depending on which value is lower.
- The nominal DCR is measured at point \triangle , as shown below on the mechanical drawing.
- The saturation current is the typical current which causes the inductance to drop by 20% at the stated ambient temperatures (25°C, 100°C). This current is determined by placing the component in the specified ambient environment and applying a short duration pulse current (to eliminate self-heating effects) to the component.
- The heating current is the DC current which causes the part temperature to increase by approximately 40°C when used in a typical application.
- In high volt*time applications, additional heating in the component can occur due to core losses in the inductor which may necessitate derating the current in order to limit the temperature rise of the component. To determine the approximate total losses (or temperature rise) for a given application, the coreloss and temperature rise curves can be used.
- Parts with the HLT suffix are sold in tape and reel packaging. Pulse complies to industry standard tape and reel specification EIA-481. The tape and reel for this product has a width (W=16mm), pitch (Po=12mm) and depth (Ko=6.8mm). Samples of these parts can be ordered by removing the HLT suffix and replacing with HL.
- The temperature of the component (ambient plus temperature rise) must be within the stated operating temperature range.
- Sample Value only. Guaranteed by Design and not tested in production

Mechanical

PGL6312.XXXHLT

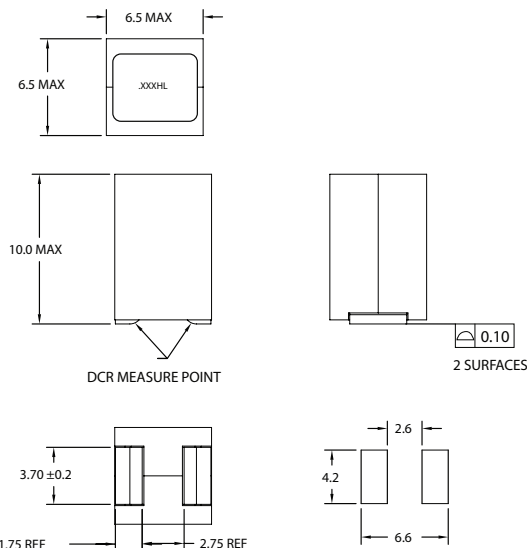

Schematic

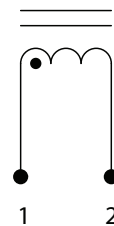

Weight: 2.74grms

Tape & Reel: 400/ Reel

Dimensions: mm

Unless otherwise specified, all tolerances are ± 0.25

TAPE & REEL INFO

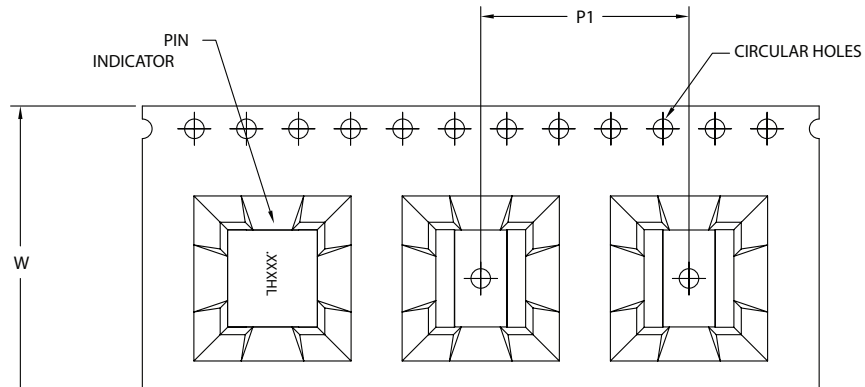

SURFACE MOUNTING TYPE, REEL/TAPE LIST

TYPE	REEL SIZE (mm)		TAPE SIZE (mm)	QTY
	$W \pm 0.30$	$P1 \pm 0.1$	$K0 \pm 0.1$	PCS/REEL
PGL6312.XXXHLT	16.0	12.0	10.1	400

PGL6312.XXXHLT, L vs I, Curve 25°C

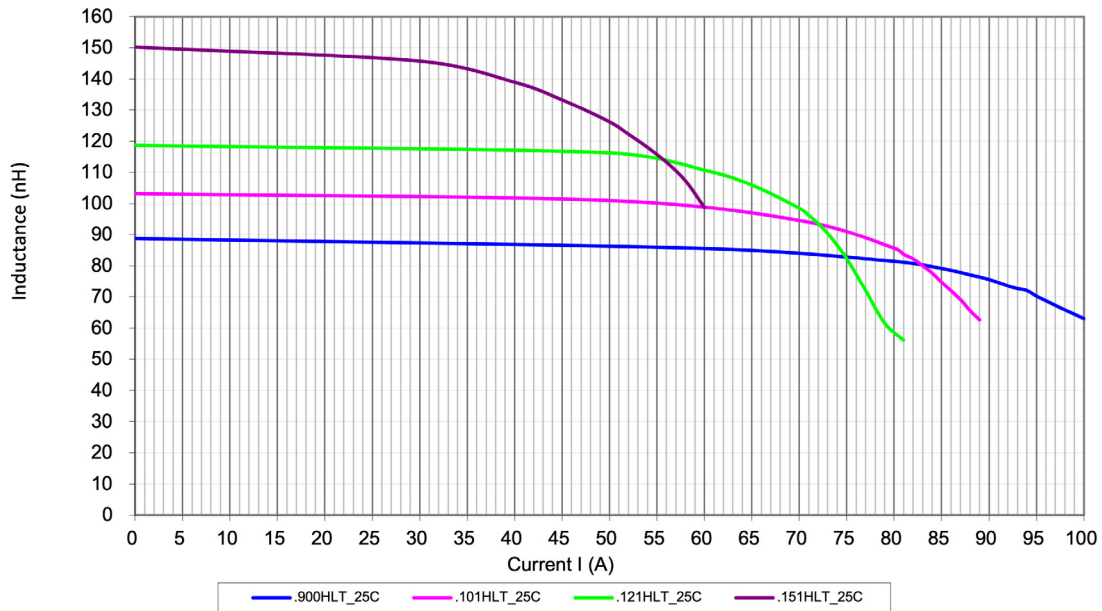

PGL6312.XXXHLT, L vs I, Curve 100°C

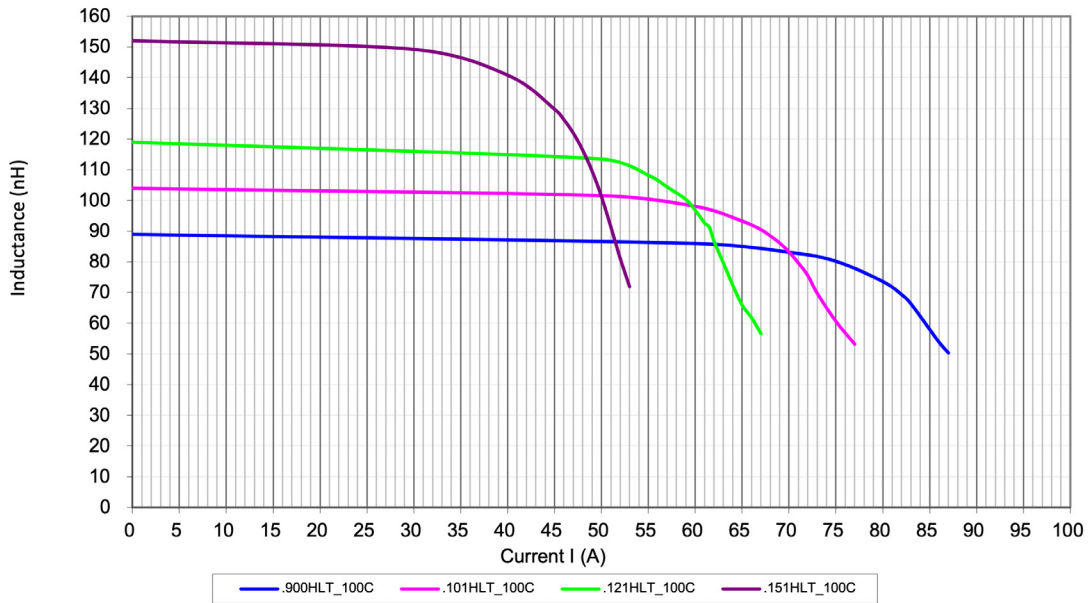

PGL6312.XXXHLT, Core Loss

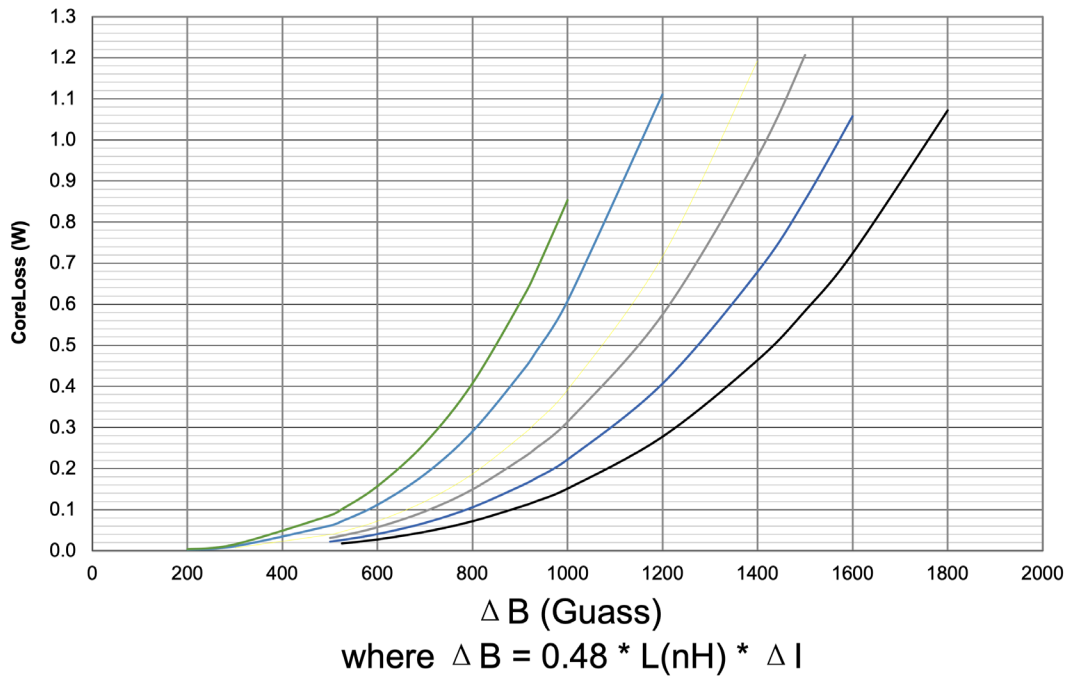

SMT Power Inductors

Power Beads - PGL6312.XXXHLT Series

PGL6312.XXHLT Temp Rise vs Power Dissipation

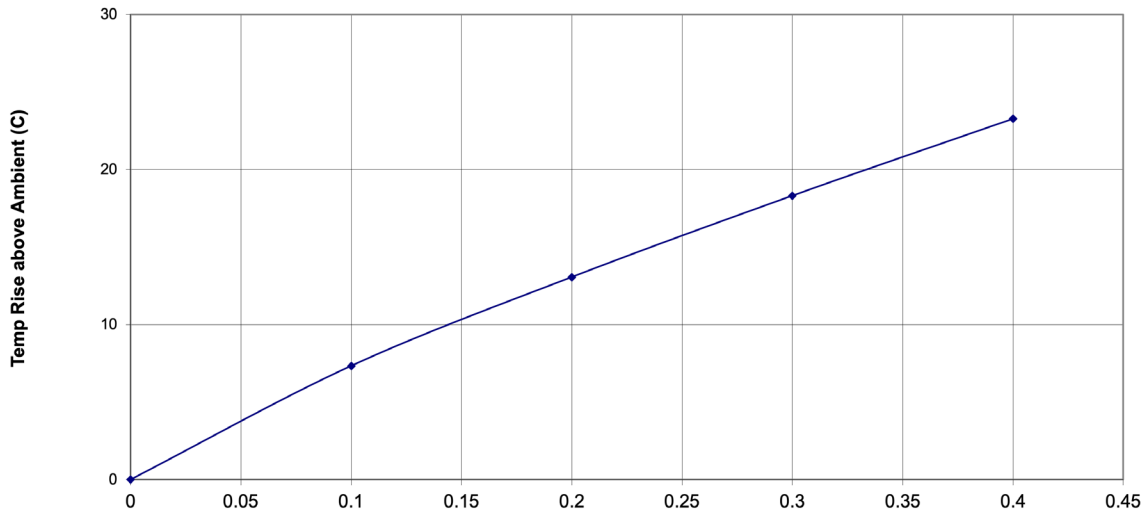

For More Information:

Americas - prodinfo_power@pulseelectronics.com | Europe - power-apps-europe@pulseelectronics.com | Asia - power-apps-asia@pulseelectronics.com

Performance warranty of products offered on this data sheet is limited to the parameters specified. Data is subject to change without notice. Other brand and product names mentioned herein may be trademarks or registered trademarks of their respective owners. © Copyright, 2021. Pulse Electronics, Inc. All rights reserved.

单击下面可查看定价，库存，交付和生命周期等信息

[>>Pulse\(普思\)](#)