

PIMinator™ Series Low PIM In-building Omni Antenna with NF Connector

Pulse Part Number DASLTENF

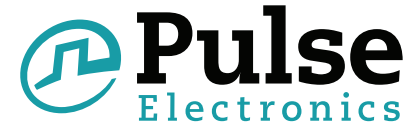

Industry leading -155 dBc certified low Passive Inter-Modulation (PIM) Distributed Antenna System (DAS) In-Building ceiling mount omni antennas. The Pulse Electronics line of DAS in-building low PIM omni antennas meet the most demanding PIM requirements for 2G, 3G, and LTE/4G bands.

These low PIM antennas help meet increasing demand for high data rates and streaming video for mobile devices. The wide band design meets the needs of operators around the world.

Features

- Industry leading -155 dBc PIM rating
- Covers cellular bands, WiFi and WiMAX from 698 through 5900MHz
- Aesthetically pleasing injection molded radome
- PIM certified
- RoHS compliant product
- Patent pending

Applications

- In-Building DAS systems requiring best PIM performance

Confidential and Proprietary — Pulse Electronics — All Rights Reserved — 2013

This document contains confidential and proprietary information of Pulse Electronics, Inc. (Pulse) and is protected by copyright, trade secret and other state and federal laws. Its receipt or possession does not convey any rights to reproduce, disclose its contents, or to manufacture, use or sell anything it may describe. Reproduction, disclosure or use without specific written authorization of Pulse is strictly forbidden.

San Diego, CA 858 674 8100

Vancouver, WA 360 944 7551

Europe 49 7032 7806 0

Asia 86 755 33966678

North Asia 886 3 4356768

China 86 512 6807 9998

PIMinator™ Series

Low PIM In-building Omni Antenna with NF Connector

Pulse Part Number DASLTENF

Electrical Specifications

Frequency [MHz]		698-960/1710-2170/ 2300-2700/4900-5900
Nominal Impedance [Ω]		50
VSWR	698-960 MHz	1.8:1
	1710-5900 MHz	1.5:1
Gain	698-960 MHz [dBi typ]	2
	1710-2700 MHz [dBi typ]	6
	4900-5900 MHz [dBi typ]	8
Radiation Pattern	HPBW Horizontal Plane at 45° [°]	360
	HPBW Vertical Plane (698-960) [° typ]	85
	HPBW Vertical Plane (1710-5900) [° typ]	50
Polarization		Vertical
Power Rating [W]		50
PIM at 2x20 Watts [dBc]		-155
Connector		N Female

Environmental Specifications

Operating Temperature [°C]	-40 to +70
----------------------------	------------

Mechanical Specifications

Radome Material	UV Protected, UL94 V-0
Color	White
Weight [oz/g]	17.28 / 490
Overall Height [Inches/mm]	4.81 / 122.1
Diameter [Inches/mm]	8.27 / 210.2
Mounting	Ceiling mounting plate (included) [.875"/22.2mm Ø hole]

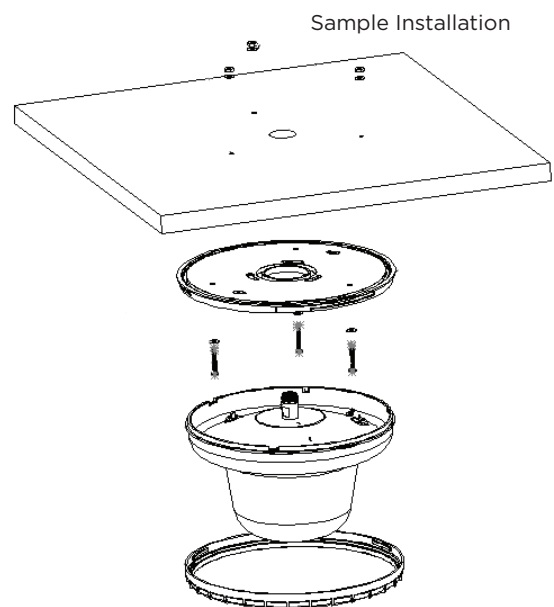

PIMinator™ Series

Low PIM In-building Omni Antenna with NF Connector

Pulse Part Number DASLTENF

Radiation Patterns

Horizontal Plane - 698-960 MHz

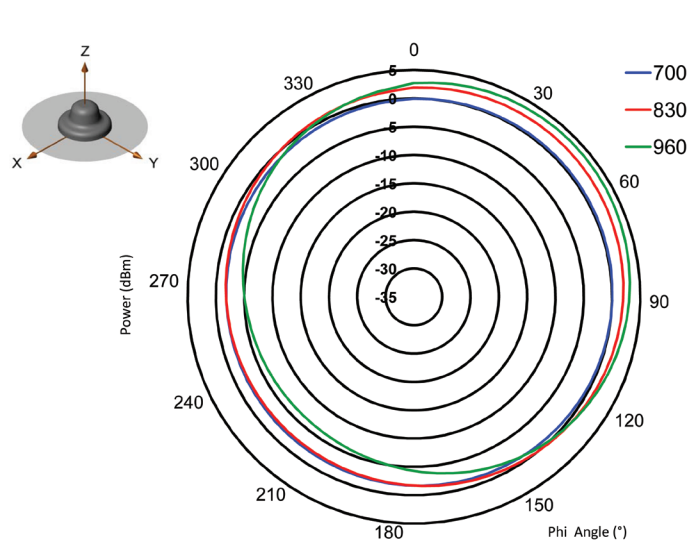

Horizontal Plane - 1710-2170 MHz

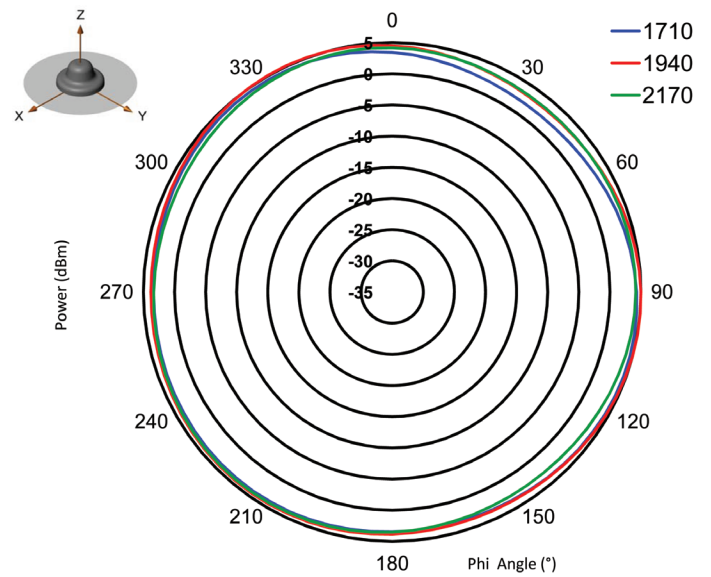

Vertical Plane - 698-960 MHz

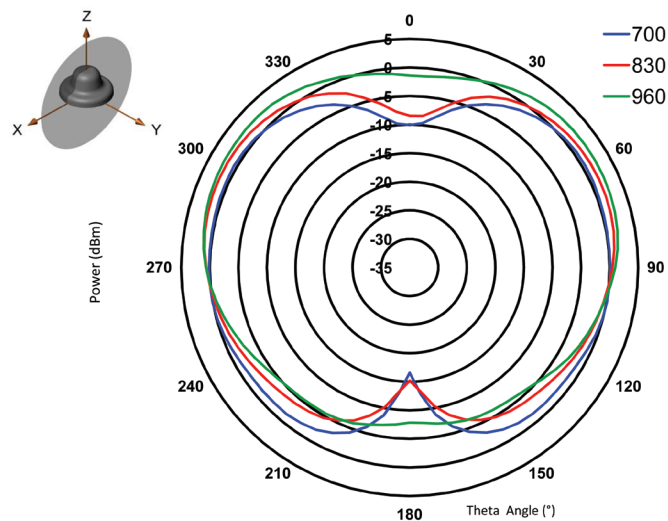

Vertical Plane - 1710-2170 MHz

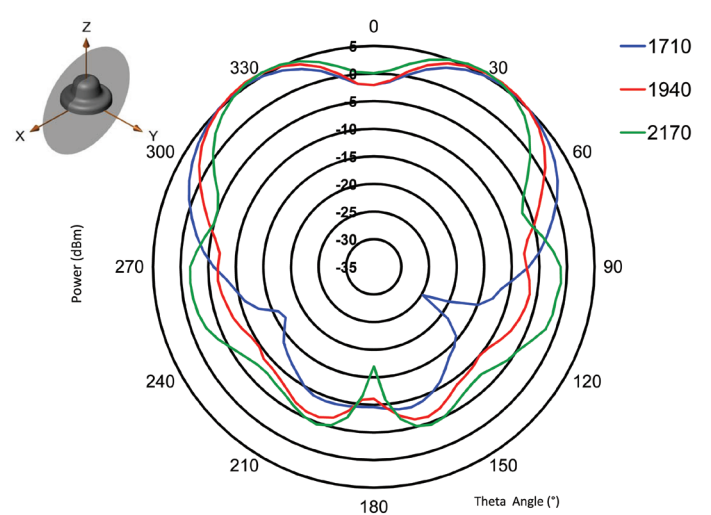

PIMinator™ Series

Low PIM In-building Omni Antenna with NF Connector

Pulse Part Number DASLTENF

Radiation Patterns

Horizontal Plane - 2300-2700 MHz

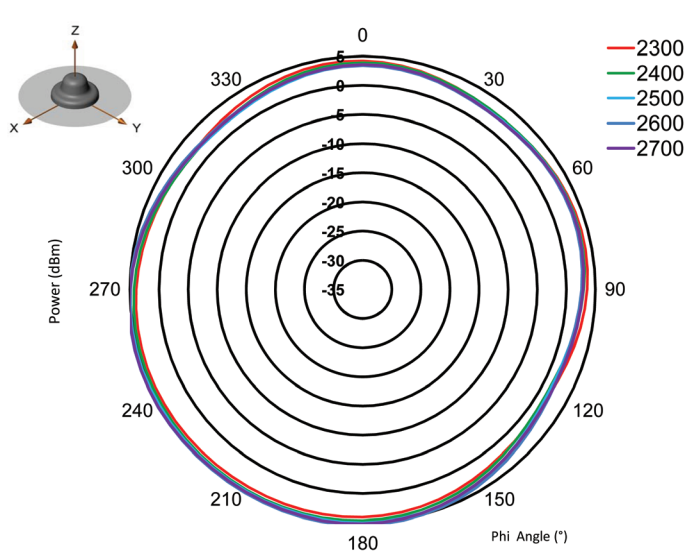

Horizontal Plane - 4900-5900 MHz

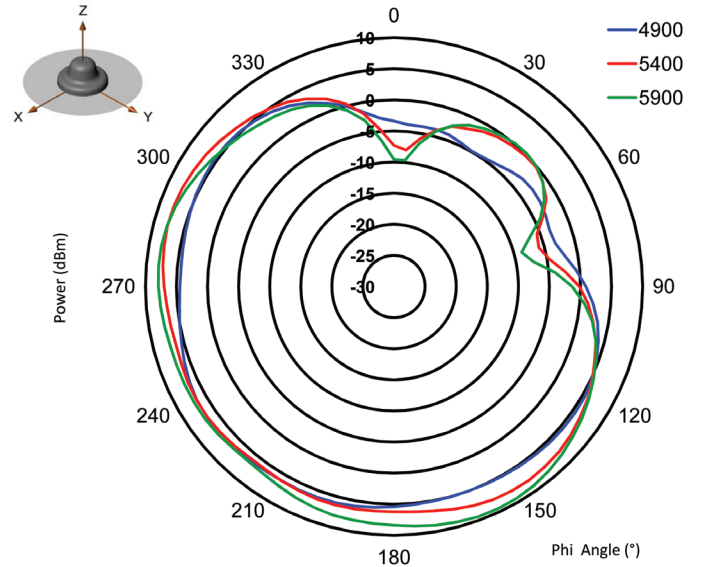

Vertical Plane - 2300-2700 MHz

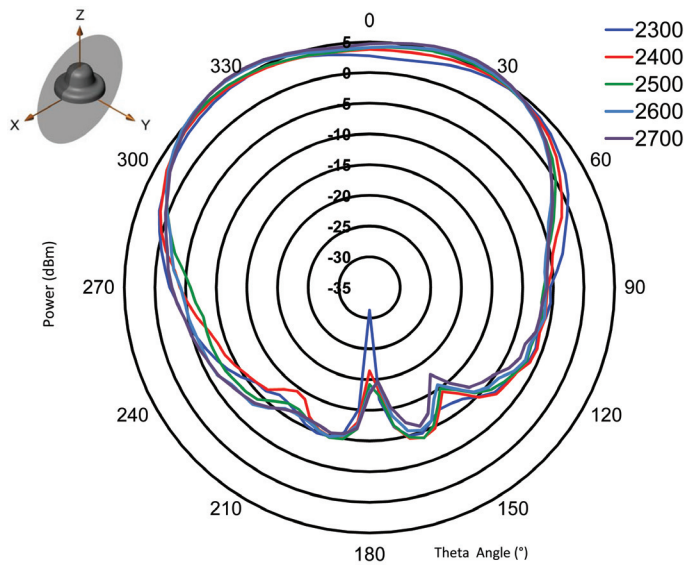

Vertical Plane - 4900-5900 MHz

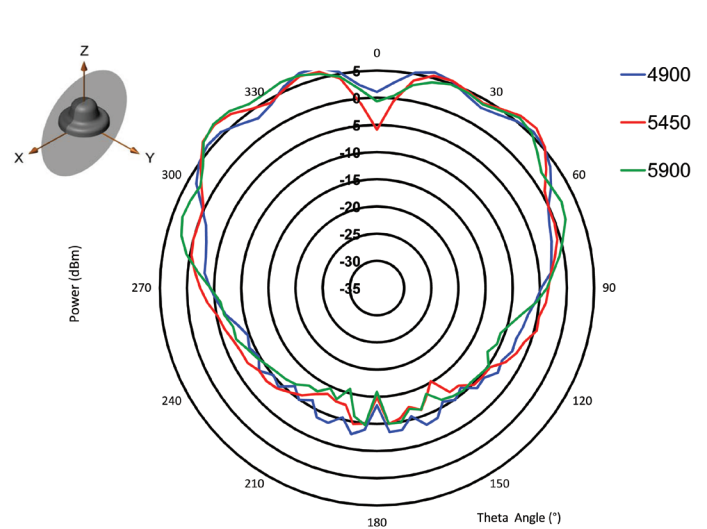

For More Information

Pulse Worldwide Headquarters
12220 World Trade Drive
San Diego, CA 92128
U.S.A.

Larsen Brand Antennas
3611 NE 112th Avenue
Vancouver, WA 98682
USA

Europe Headquarters
Pulse GmbH & Co. KG
Zeppelinstrasse 15
Herrenberg
Germany

Asia Headquarters
B402, Shenzhen Academy of
Aerospace Technology Bldg,
10th Kejian Road, High-Tech Zone
Nanshan District, Shenzhen, PR China 518057

Pulse North Asia
3F, No. 198, Zhongyuan Road
Zhongli City, Taoyuan County 320
Taiwan R. O. C.

Pulse (Suzhou) Wireless Products Co., Inc.
99 Huo Ju Road, (#29 Bldg, 4th Phase)
Suzhou New District
Science & Tech Industrial Park
Jiangsu Province, Suzhou 215009 PR China

Tel: 858 674 8100
Fax: 858 674 8262

Tel: 360 944 7551
Fax: 369 944 7556

Tel: 49 7032 7806 0
Fax: 49 7032 7806 135

Tel: 86 755 33966678
Fax: 86 755 33966700

Tel: 886 3 4356768
Fax: 886 3 4356823

Tel: 86 512 6807 9998
Fax: 86 512 6809 8023

Performance warranty of products offered on this data sheet is limited to the parameters specified. Data is subject to change without notice. Other brand and product names mentioned herein may be trademarks or registered trademarks of their respective owners. © Copyright, 2010, Pulse Electronics, Inc. All rights reserved.

单击下面可查看定价，库存，交付和生命周期等信息

[>>Pulse\(普思\)](#)