

NOTES:

1. ROHS COMPLIANT
2. HEADER: DAP (DIALLYL PHTHALATE) WITH FLAMMABILITY RATING UL 94V-0 OR BETTER.
3. STORAGE TEMPERATURE: -50°C TO +125°C
4. COMPLIANCE TO J-STD:
 - A. J-STD-002: SOLDERABILITY AT 245°C REFLOW PROFILE
 - B. J-STD-020: LEVEL 1, NO MOISTURE SENSITIVE
 - C. J-STD-075: R7, 245°C MAXIMUM THROUGH REFLOW SOLDER
5. TO ORDER TAPE & REEL PACKAGING ADD A "T" SUFFIX TO THE PART NUMBER(i.e HX1344NL BECOMES HX1344NLT).

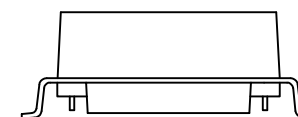
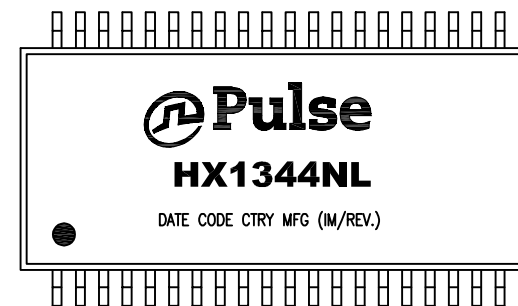

FINAL OUTLINE

© Copyright, 2016. Pulse Electronics Corp. All rights reserved. Pulse confidential & proprietary. (03/03/16)

PRODUCT DESCRIPTION	TLA DRAWING	PS DRAWING	SHEET	PART NO.	DATASHEET REV.
MDL,QUAD,100D,1:1,SM,TU	HX1344NL-X1	-	1 OF 3	HX1344NL	B

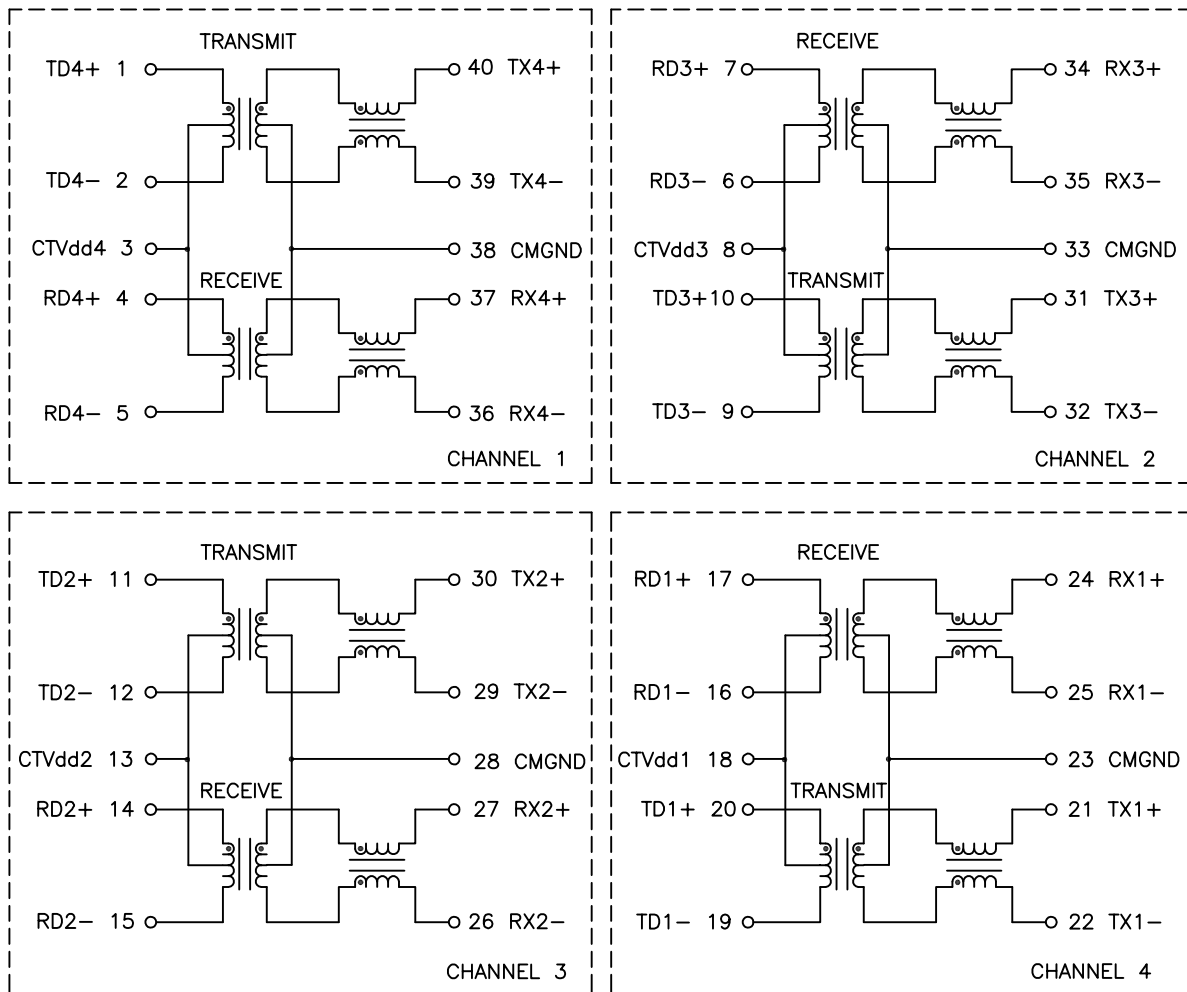

SCHEMATIC

MEETS IEEE802.3u & SUPPORTS INDUSTRIAL ETHERNET PROTOCOLS
EtherCAT, Profi-BUS, PowerLink, DeviceNET, MODbus

PARAMETER	SPECIFICATIONS		
OPERATING TEMP	-40°C TO +85°C		
POLARITY	PER SCHEMATIC		
URNS RATIO	1.00 ±2%		
INSERTION LOSS	100 KHz	1-125 MHz	
	-1.2 dB MAX	-0.2-0.002*f ^{1.4} dB MAX	
RETURN LOSS, 1000BT (Z OUT = 100 OHM ±15%)	.1-30 MHz	30-60 MHz	60-80 MHz
	-16 dB MIN	-10+20*LOG ₁₀ (f/60 MHz) dB MIN	-10 dB MIN
INDUCTANCE (OCL) MEDIA SIDE	350 uH MIN (MEASURED AT 100 KHz, 100 mVRMS AND WITH 8 mA DC BIAS)		
CROSSTALK, ADJACENT CHANNELS	1-100 MHz		
	-30 dB MIN		
DIFFERENTIAL TO COMMON MODE REJECTION	1-100 MHz		
	-30 dB MIN		
DC RESISTANCE, 1/2 WINDING	.65 OHMS MAX		
DC RESISTANCE IMBALANCE	±.065 OHMS MAX (CENTER TAP SYMMETRY)		
INPUT - OUTPUT ISOLATION	1500 VRMS MIN @ 60 SECONDS		

NOTE: f IS FREQUENCY IN MHZ.

© Copyright, 2016. Pulse Electronics Corp. All rights reserved. Pulse confidential & proprietary. (03/03/16)

PRODUCT DESCRIPTION	TLA DRAWING	PS DRAWING	SHEET	PART NO.	DATASHEET REV.
MDL,QUAD,100D,1:1,SM,TU	HX1344NL-X1	-	2 OF 3	HX1344NL	B

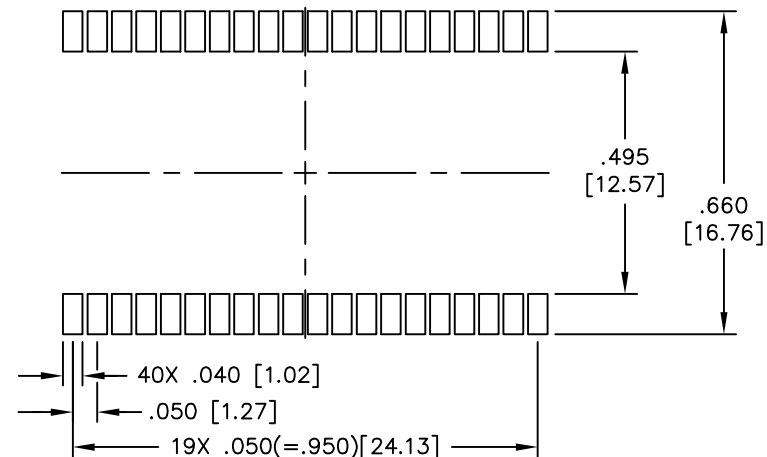
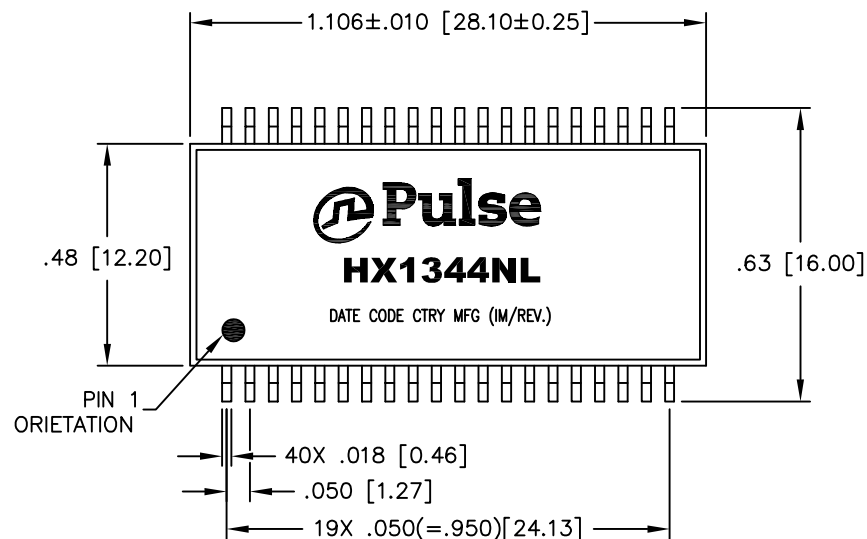

SUGGESTED LBND PBTERN

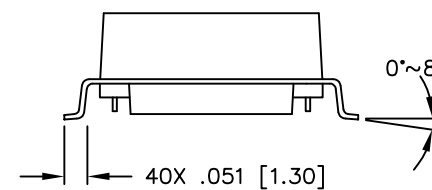
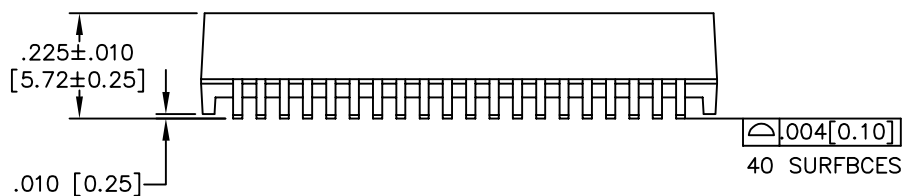

DIMENSIONS ARE IN INCHES [MILLIMETERS] WITH THE FOLLOWING TOLERANCES: [MILLIMETERS] ARE FOR REFERENCE ONLY.
 .XX= ±.01 [±0.25]
 .XXX= ±.005 [±0.13]

© Copyright, 2016. Pulse Electronics Corp. All rights reserved. Pulse confidential & proprietary. (03/03/16)

PRODUCT DESCRIPTION	TLA DRAWING	PS DRAWING	SHEET	PART NO.	DATASHEET REV.
MDL,QUAD,100D,1:1,SM,TU	HX1344NL-X1	-	3 OF 3	HX1344NL	B

单击下面可查看定价，库存，交付和生命周期等信息

[>>Pulse\(普思\)](#)