

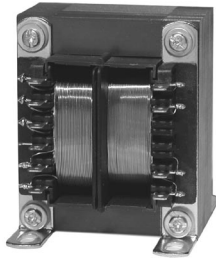



LAMINATED TRANSFORMERS

Low Frequency, Open-Style Laminated, International High Power Series



AGENCY APPROVALS

- UL, 506, File E73539
- UL Recognized Class B
- UL 1446, File E179499
- CSA 22.2#66, File LR68051-2
- TUV, EN61558





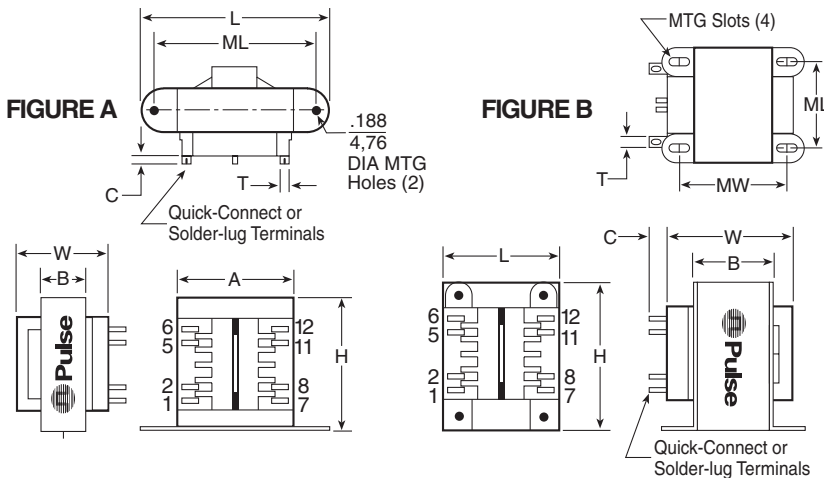

- ⊕ Chassis mounting
- ⊕ Dual bobbin; double reinforced insulation
- ⊕ High (4000V) primary to secondary isolation
- ⊕ Non-concentric design - eliminates ESS and reduces primary to secondary capacitance
- ⊕ No crossover between primary/secondary leads
- ⊕ Baked resin provides environmentally-resistant finish

Mechanical

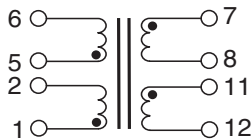

Schematic



Part No.	VA	Secondary RMS Rating	
A41-25-10A1	25	10V C.T. @ 2.5A	5V @ 5.0A
A41-43-10A2	43	10V C.T. @ 4.3A	5V @ 8.6A
A41-80-10A3	80	10V C.T. @ 8.0A	5V @ 16.0A
A41-130-10A4	130	10V C.T. @ 13.0A	5V @ 26.0A
A41-175-10A5	175	10V C.T. @ 17.5A	5V @ 35.0A
A41-25-12A7	25	12.6V C.T. @ 2.0A	6.3V @ 4.0A
A41-43-12A8	43	12.6V C.T. @ 3.4A	6.3V @ 6.8A
A41-80-12A9	80	12.6V C.T. @ 6.3A	6.3V @ 12.6A
A41-130-12A10	130	12.6V C.T. @ 10.3A	6.3V @ 20.6A
A41-175-12A11	175	12.6V C.T. @ 14.0A	6.3V @ 28.0A
A41-25-16A13	25	16V C.T. @ 1.6A	8V @ 3.2A
A41-43-16A14	43	16V C.T. @ 2.7A	8V @ 5.4A
A41-80-16A15	80	16V C.T. @ 5.0A	8V @ 10.0A
A41-130-16A16	130	16V C.T. @ 8.1A	8V @ 16.2A
A41-175-16A17	175	16V C.T. @ 11.0A	8V @ 22.0A
A41-25-20A19	25	20V C.T. @ 1.25A	10V @ 2.5A
A41-43-20A20	43	20V C.T. @ 2.2A	10V @ 4.4A
A41-80-20A21	80	20V C.T. @ 4.0A	10V @ 8.0A
A41-130-20A22	130	20V C.T. @ 6.5A	10V @ 13.0A
A41-175-20A23	175	20V C.T. @ 8.8A	10V @ 17.6A
A41-25-24A25	25	24V C.T. @ 1A	12V @ 2A
A41-43-24A26	43	24V C.T. @ 1.8A	12V @ 3.6A
A41-80-24A27	80	24V C.T. @ 3.3A	12V @ 6.6A
A41-130-24A28	130	24V C.T. @ 5.4A	12V @ 10.8A
A41-175-24A29	175	24V C.T. @ 7.3A	12V @ 14.6A
A41-25-28A31	25	28V C.T. @ 0.9A	14V @ 1.86A
A41-43-28A32	43	28V C.T. @ 1.5A	14V @ 3.0A
A41-80-28A33	80	28V C.T. @ 2.8A	14V @ 5.6A
A41-130-28A34	130	28V C.T. @ 4.6A	14V @ 9.2A
A41-175-28A35	175	28V C.T. @ 6.25A	14V @ 12.5A
A41-25-36A37	25	36V C.T. @ 0.7A	18V @ 1.4A
A41-43-36A38	43	36V C.T. @ 1.2A	18V @ 2.4A
A41-80-36A39	80	36V C.T. @ 2.2A	18V @ 4.4A
A41-130-36A40	130	36V C.T. @ 3.6A	18V @ 7.2A
A41-175-36A41	175	36V C.T. @ 4.8A	18V @ 9.6A
A41-25-230A42	25	230V C.T. @ 0.11A	115V @ 0.22A
A41-43-230A43	43	230V C.T. @ 0.19A	115V @ 0.38A
A41-80-230A44	80	230V C.T. @ 0.35A	115V @ 0.7A
A41-130-230A45	130	230V C.T. @ 0.57A	115V @ 1.14A
A41-175-230A46	175	230V C.T. @ 0.76A	115V @ 1.52A

Dimensions (inches)

VA (size)	Wt. (lb.)	L	W	H	A	B	C	T	ML	MW	MTG.	FIG.
25	1.25	2.812	1.875	2.312	2.00	1.125	0.330	0.187	2.375	—	#6	A
43	1.60	3.125	2.062	2.687	2.25	1.125	0.312	0.187	2.812	—	#6	A
80	2.80	2.500	2.375	3.050	—	1.375	0.330	0.187	2.000	2.180	#6	B
130	4.10	2.812	2.875	3.380	—	1.625	0.395	0.187	2.250	2.500	#8	B
175	5.50	3.125	2.875	3.750	—	1.625	0.395	0.187	2.500	2.500	#8	B

USA 858 674 8100 • Germany 49 7032 7806 0 • Singapore 65 6287 8998 • Shanghai 86 21 54643211 / 2 • China 86 769 85538070 • Taiwan 886 3 4641811

单击下面可查看定价，库存，交付和生命周期等信息

[>>Pulse\(普思\)](#)