

*Application note*

## Ceramic Dual Band Monopole Antenna

### EGSM900 and PCN1800

*10 mm x 3.2 mm x 2 mm Ceramic Chip Antenna*

*Ground Cleared Under Antenna:*

*Version 1: 25 mm x 10 mm*

*Version 2: 40 mm x 10 mm*

*Pulse Part Number: W3070*

#### Status

Author	MiJu	Version	4.0.0
Checked by		Date	02.07.2009
Approved by		Date	

#### Pulse Finland Oy

Takatie 6  
90440 Kempele, Finland  
Tel: +358 207 935 500  
Fax: +358 207 935 501

Domicile: Kempele  
Business ID: 1933992-8  
[firstname.lastname@pulseeng.com](mailto:firstname.lastname@pulseeng.com)  
[www.pulseeng.com/antennas](http://www.pulseeng.com/antennas)



© 2006. All Rights Reserved.

# Table of Content

General Features and Applications .....	3
Terminal configuration and antenna dimensions.....	4
Test setup for electrical measurements .....	5
Electrical performance test results.....	7
Packing .....	13
Mechanical Outline .....	16
Contact information .....	17

## Pulse Finland Oy

Takatie 6  
90440 Kempele, Finland  
Tel: +358 207 935 500  
Fax: +358 207 935 501

Domicile: Kempele  
Business ID: 1933992-8  
[firstname.lastname@pulseeng.com](mailto:firstname.lastname@pulseeng.com)  
[www.pulseeng.com/antennas](http://www.pulseeng.com/antennas)



© 2006. All Rights Reserved.,

# Ceramic Chip Antenna

*Ground Cleared Under Antenna*

## Features

- Low profile
- Compact size W x L x H (10 x 3.2 x 2 mm)
- Low weight (240 mg)
- Lead free materials
- Fully SMD compatible
- Lead free soldering compatible
- Tape and reel packing
- RoHS Compliant Product

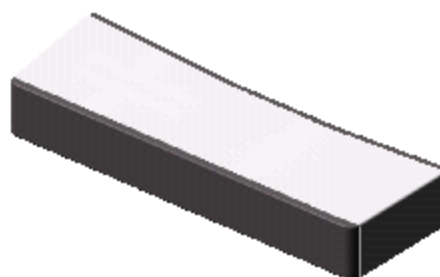

## Applications

- EGSM900 and PCN1800 radios

## Electrical specifications @ +25 °C

*Note: Electrical characteristics depend on test board (GP) size and antenna positioning on GP and Ground Clearance area size.*

### W3070 Ceramic Dual Band Monopole Antenna (Version 1: Ground Cleared Under Antenna 25 mm x 10mm)

*Typical performance (test board size 95 mm x 40 mm, PWB ground clearance area 25 mm x 10 mm)*

*18nH and 10nH series-inductors used for frequency tuning and 6.8nH shunt-inductor used for impedance matching.*

Frequency Range [MHz]	3D Max Gain [dBi]	3D Efficiency [%] / [dB]	Return loss min. [dB]	Impedance [Ω]	Operating Temperature [°C]
880 - 960	+1.5 (peak) -0.4 (band edges)	70 / -1.55 (peak) 47 ; 40 / -3.3 ; -4 (band edges)	-4.7 ; -3.8 (band edges)	50	-40 to +85
1710 – 1880	+1 (peak) -1 ; +0.5 (band edges)	50 / -3 (peak) 30 ; 40 / -5.2 ; -4 (band edges)	-4 ; -4.6 (band edges)	50	-40 to +85

### W3070 Ceramic Dual Band Monopole Antenna (Version 2: Ground Cleared Under Antenna 40 mm x 10mm)

*Typical performance (test board size 95 mm x 40 mm, PWB ground clearance area 40 mm x 10 mm)*

*18nH and 10nH series-inductors used for frequency tuning.*

Frequency Range [MHz]	3D Max Gain [dBi]	3D Efficiency [%] / [dB]	Return loss min. [dB]	Impedance [Ω]	Operating Temperature [°C]
880 - 960	+1.2 (peak) -0.4 (band edges)	65 / -1.9 (peak) 47 / -3.3 (band edges)	-5.1 ; -5.3 (band edges)	50	-40 to +85
1710 – 1880	+2.5 (peak) +1.5 ; +2 (band edges)	60 / -2.2 (peak) 50 ; 55 / -3 ; -2.6 (band edges)	-5.8 ; -5.7 (band edges)	50	-40 to +85

## Pulse Finland Oy

Takatie 6  
90440 Kempele, Finland  
Tel: +358 207 935 500  
Fax: +358 207 935 501

Domicile: Kempele  
Business ID: 1933992-8  
[firstname.lastname@pulseeng.com](mailto:firstname.lastname@pulseeng.com)  
[www.pulseeng.com/antennas](http://www.pulseeng.com/antennas)



© 2006. All Rights Reserved.

# Ceramic Chip Antenna

## Terminal Configuration and Antenna Dimensions

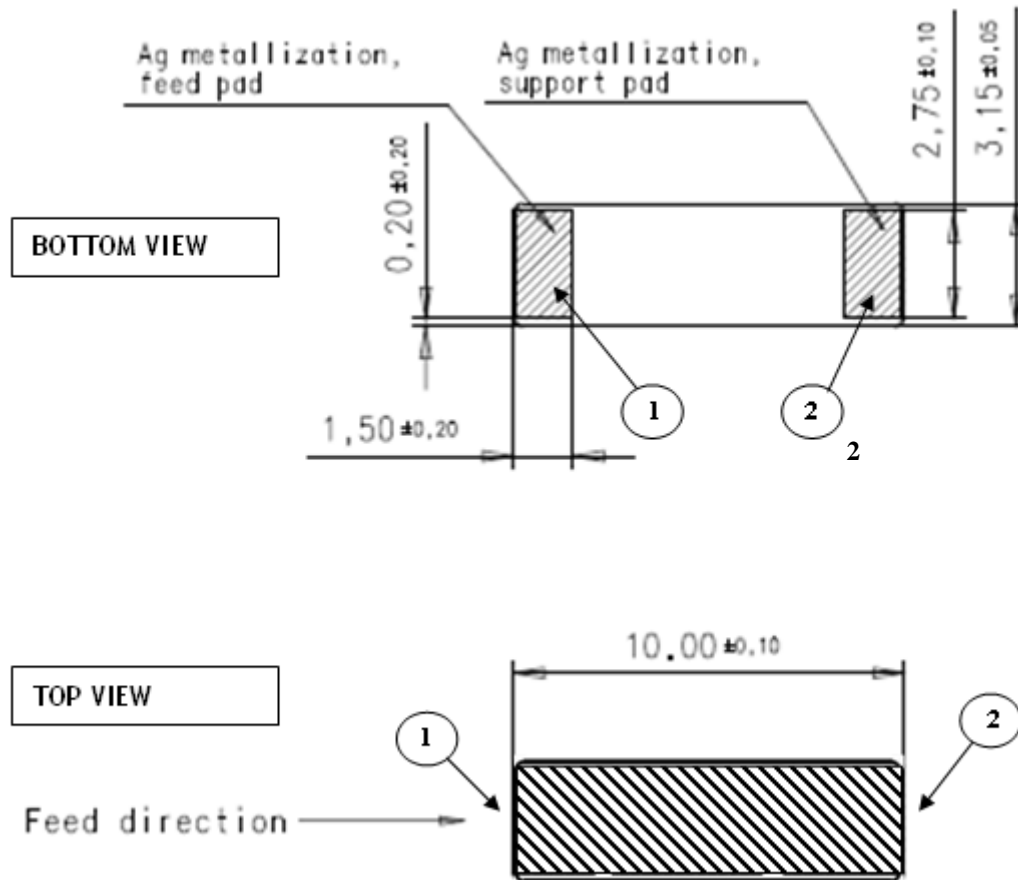

No.	Terminal Name	Terminal Dimensions
1	Feed	1.5 x 2.75 mm
2	Support pad	1.5 x 2.75 mm

Antenna is symmetrical and orientation on footprint can be rotated 180 degrees without change in performance

# Ceramic Chip Antenna

## Test Setup for Electrical Measurements

Recommended test board- layout for electrical characteristic measurement. Test board outline size 95 x 40mm.

Ground cleared under antenna, clearance area **25 mm x 10 mm**

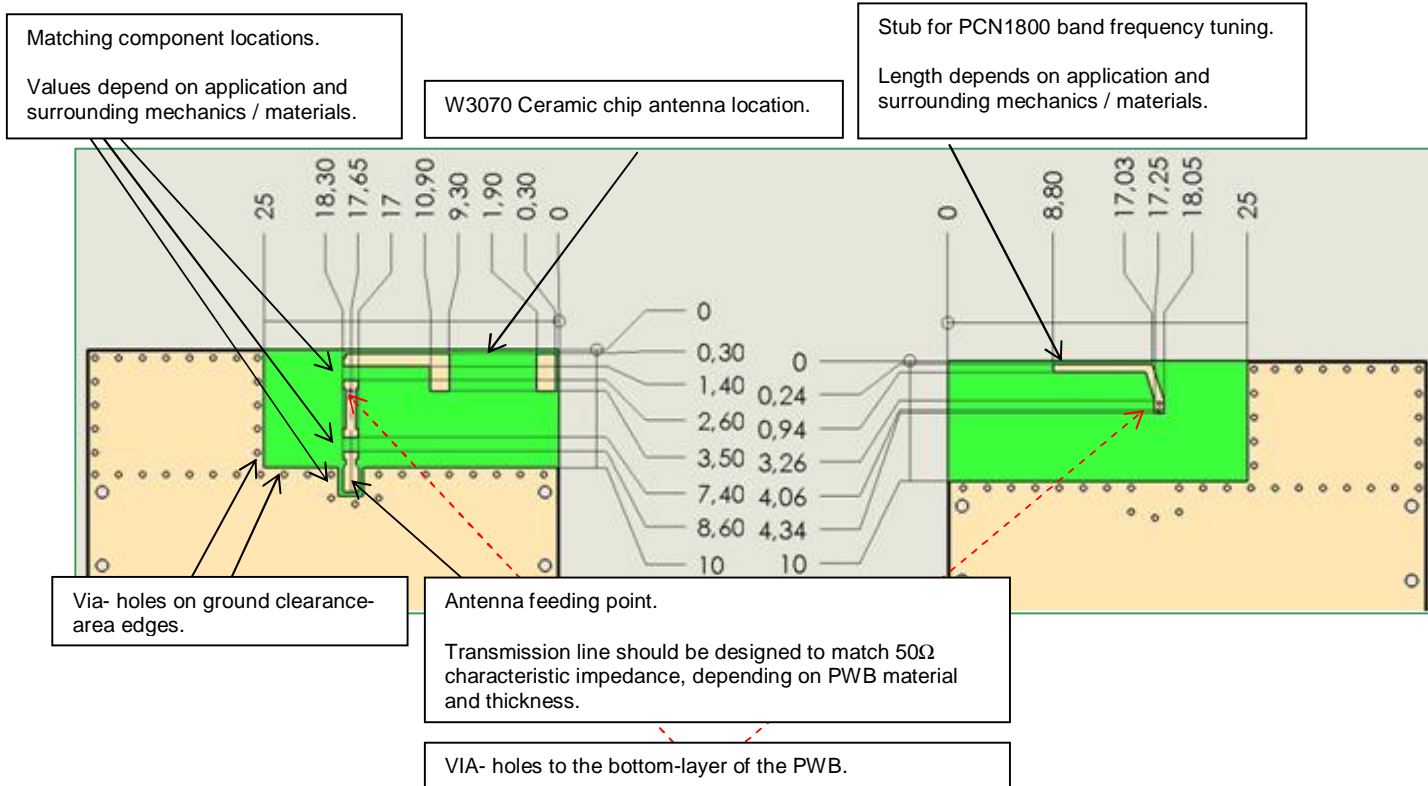

Ground cleared under antenna, clearance area **40 mm x 10 mm**

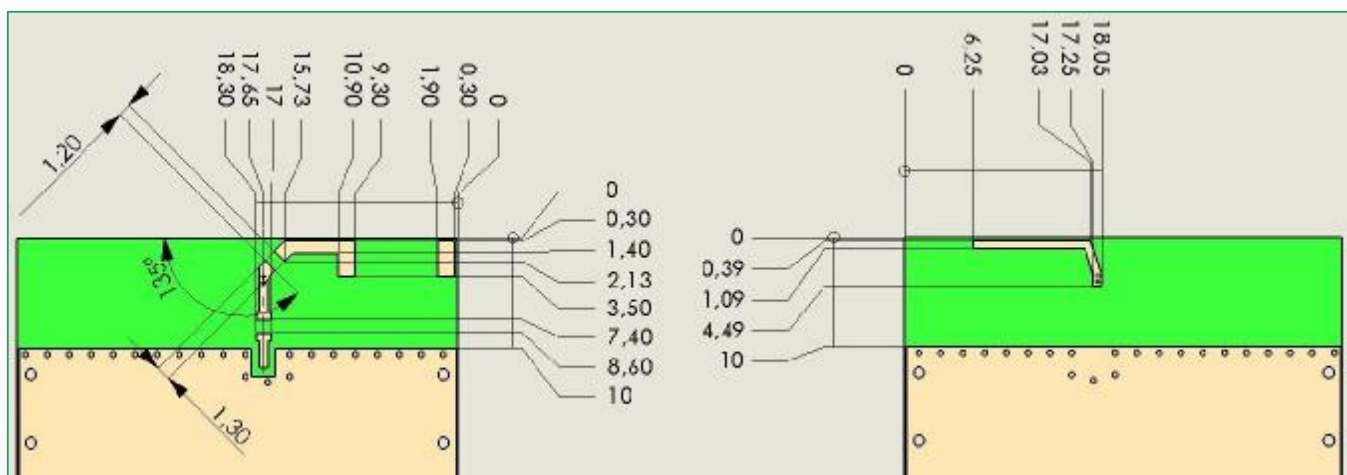

### Pulse Finland Oy

Takatie 6  
90440 Kempele, Finland  
Tel: +358 207 935 500  
Fax: +358 207 935 501

Domicile: Kempele  
Business ID: 1933992-8  
[firstname.lastname@pulseeng.com](mailto:firstname.lastname@pulseeng.com)  
[www.pulseeng.com/antennas](http://www.pulseeng.com/antennas)



*Recommended test board- layout for electrical characteristic measurement. Test board outline size 95 x 40mm.*

### 3D- view of Test Setup

Ground cleared under antenna, clearance area **25 mm x 10 mm**

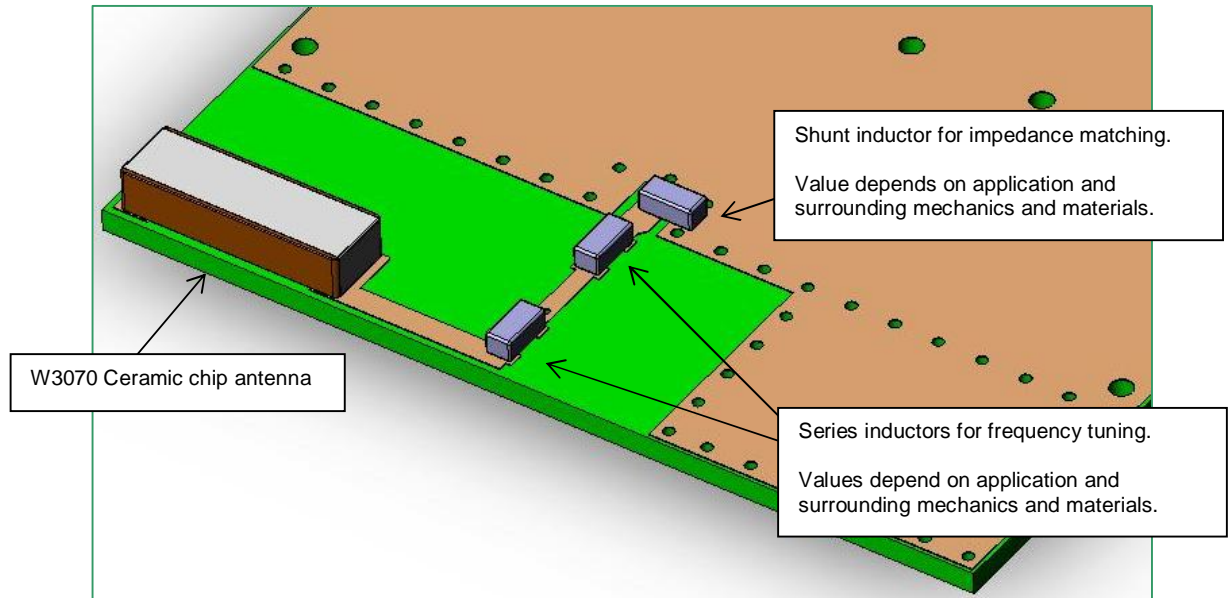

### 3D- view of Test Setup

Ground cleared under antenna, clearance area **40 mm x 10 mm**

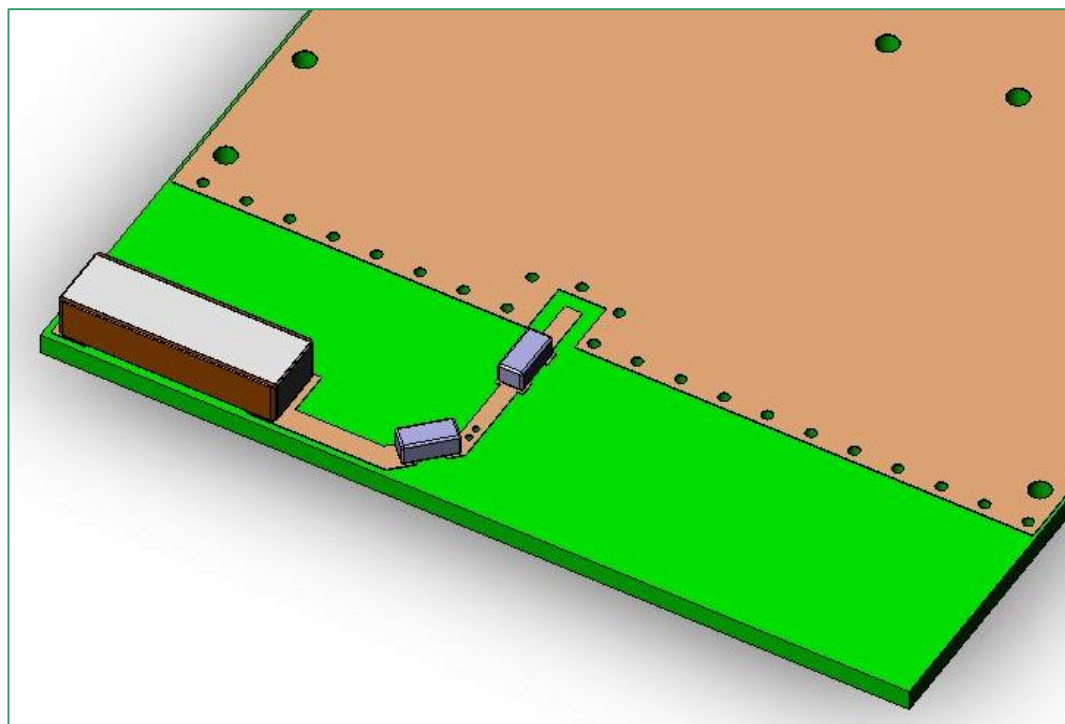

#### Pulse Finland Oy

Takatie 6  
90440 Kempele, Finland  
Tel: +358 207 935 500  
Fax: +358 207 935 501

Domicile: Kempele  
Business ID: 1933992-8  
[firstname.lastname@pulseeng.com](mailto:firstname.lastname@pulseeng.com)  
[www.pulseeng.com/antennas](http://www.pulseeng.com/antennas)



© 2006. All Rights Reserved.

# Ceramic Chip Antenna

Ground cleared under antenna. Clearance areas **25 mm x 10 mm** and **40mm x 10mm**.

## Typical Electrical Characteristics (T=25 °C)

Measured on the 95 x 40mm test board with matching circuit.

### Typical Return Loss S11

**Typical return loss-values at band edges:**

<b>880MHz</b>	<b>960MHz</b>
-5.1dB	-5.3dB
-4.7dB	-3.8dB
<b>1710MHz</b>	<b>1880MHz</b>
-5.8dB	-5.7dB
-4dB	-4.6dB

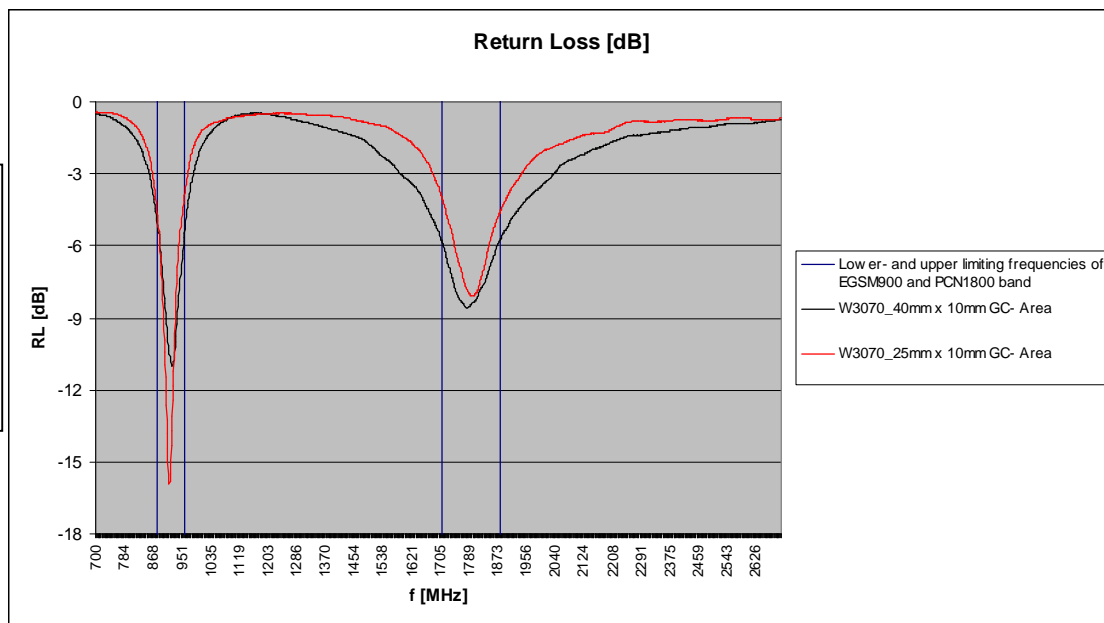

### Typical free Space Total Efficiencies [%]

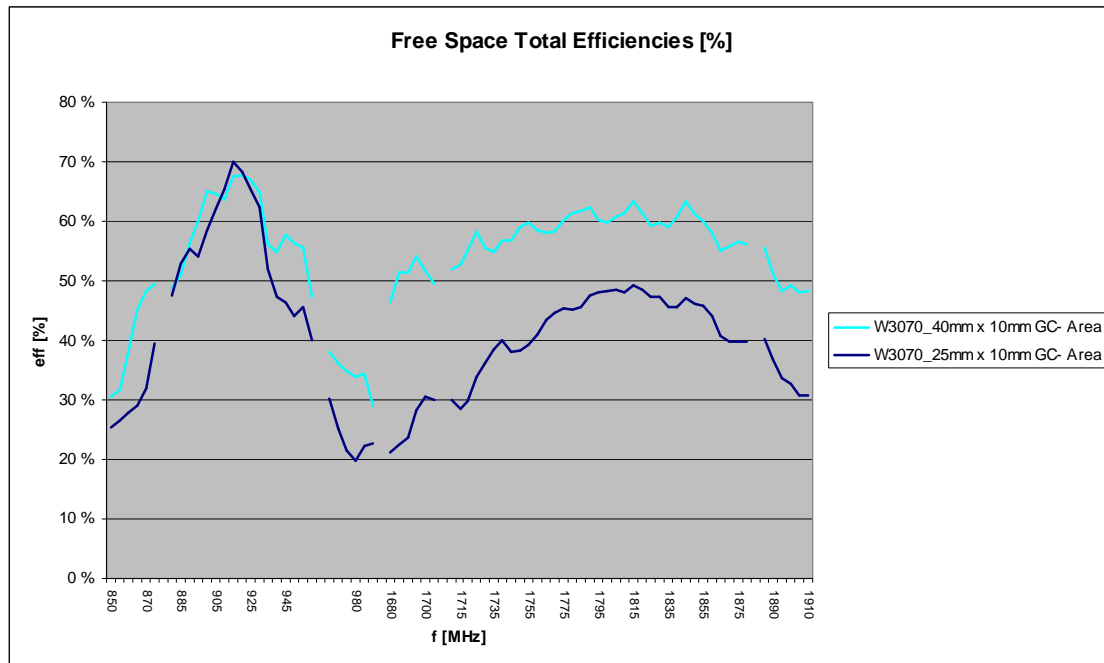

Typical free Space Total Efficiencies [dB] and Maximum Gain [dBi]

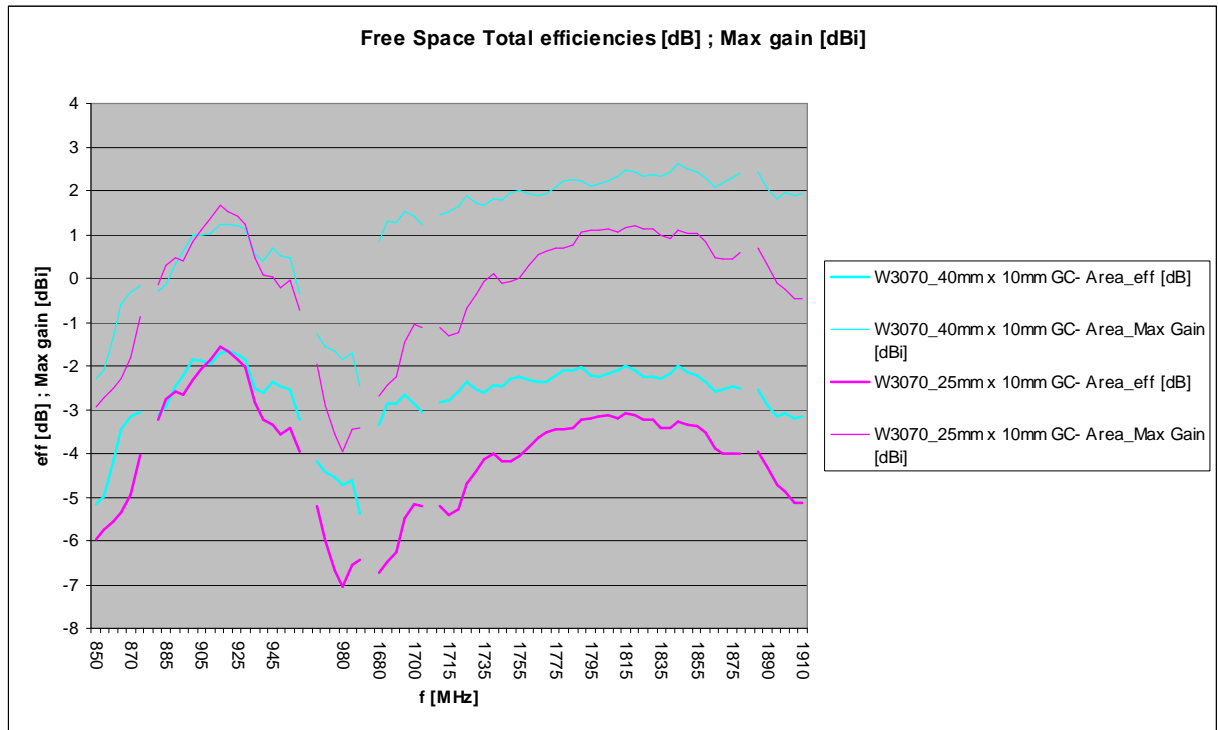

Pulse Finland Oy

Takatie 6  
 90440 Kempele, Finland  
 Tel: +358 207 935 500  
 Fax: +358 207 935 501

Domicile: Kempele  
 Business ID: 1933992-8  
[firstname.lastname@pulseeng.com](mailto:firstname.lastname@pulseeng.com)  
[www.pulseeng.com/antennas](http://www.pulseeng.com/antennas)



© 2006. All Rights Reserved.



# Ceramic Chip Antenna

Ground cleared under antenna. Clearance area **25 mm x 10mm**.

## Typical Free Space Radiation Patterns for EGSM900 Band

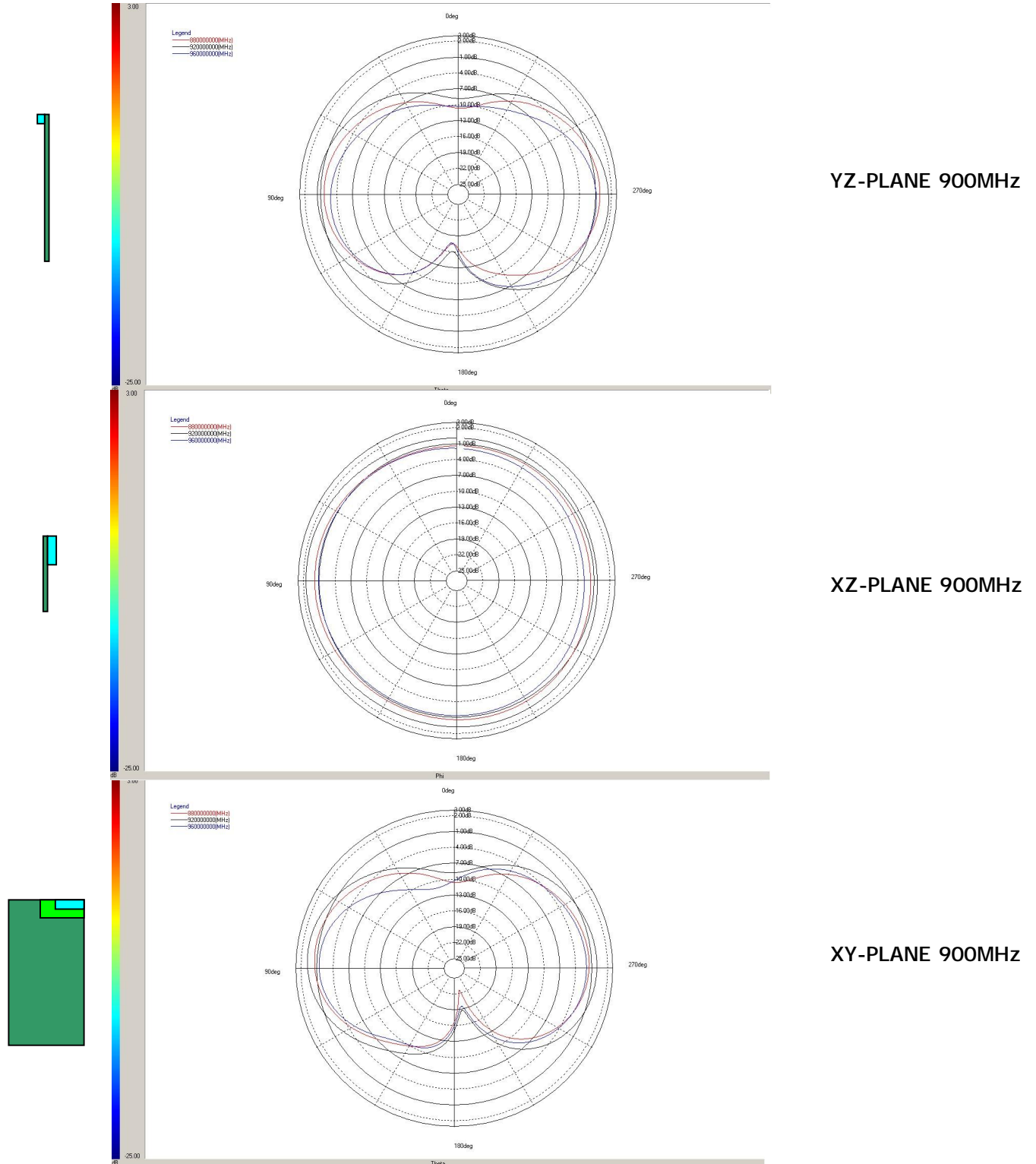

### Typical Free Space Radiation Patterns for PCN1800 Band

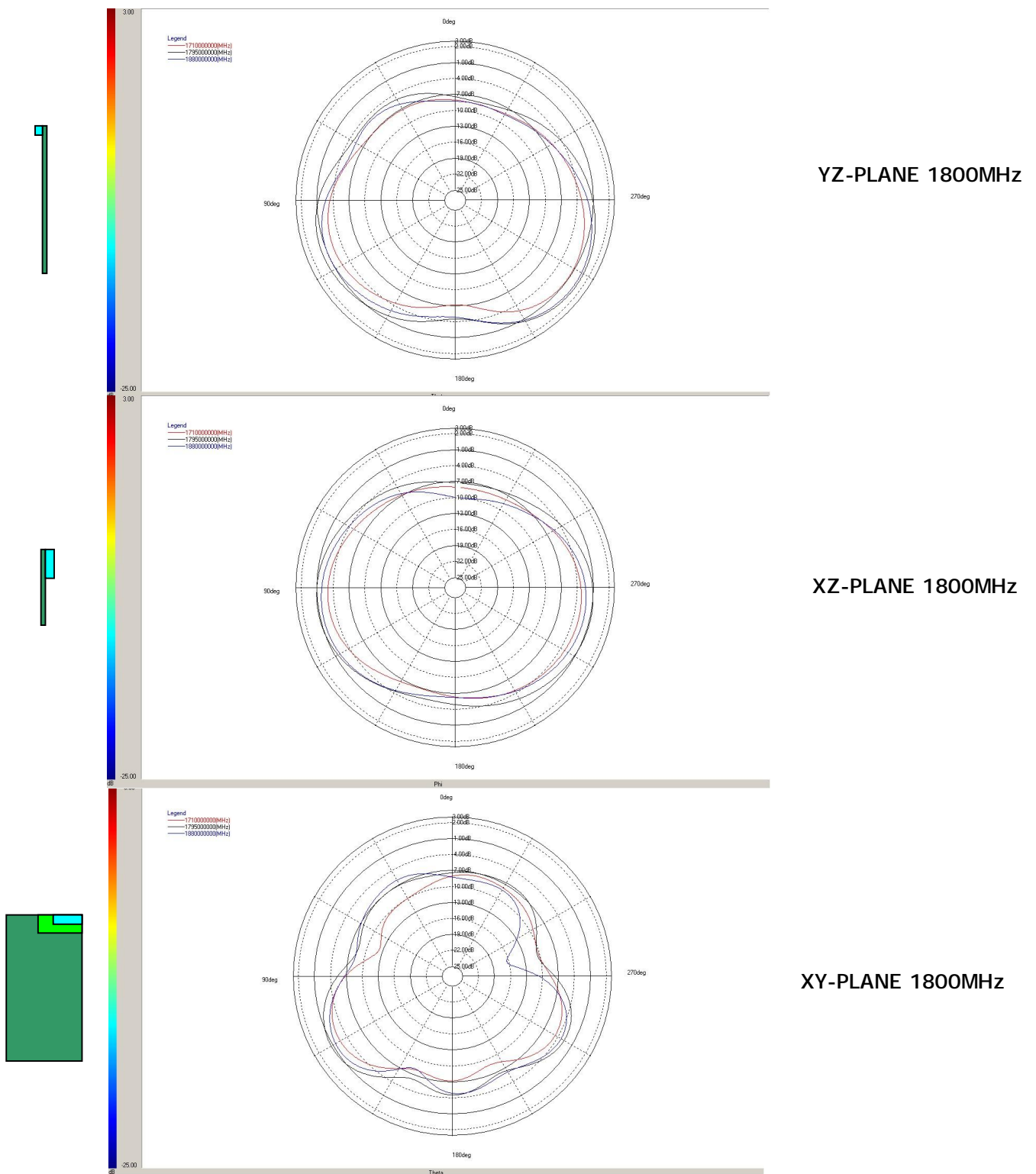

# Ceramic Chip Antenna

Ground cleared under antenna. Clearance area **40 mm x 10mm.**

## Typical Free Space Radiation Patterns for EGSM900 Band

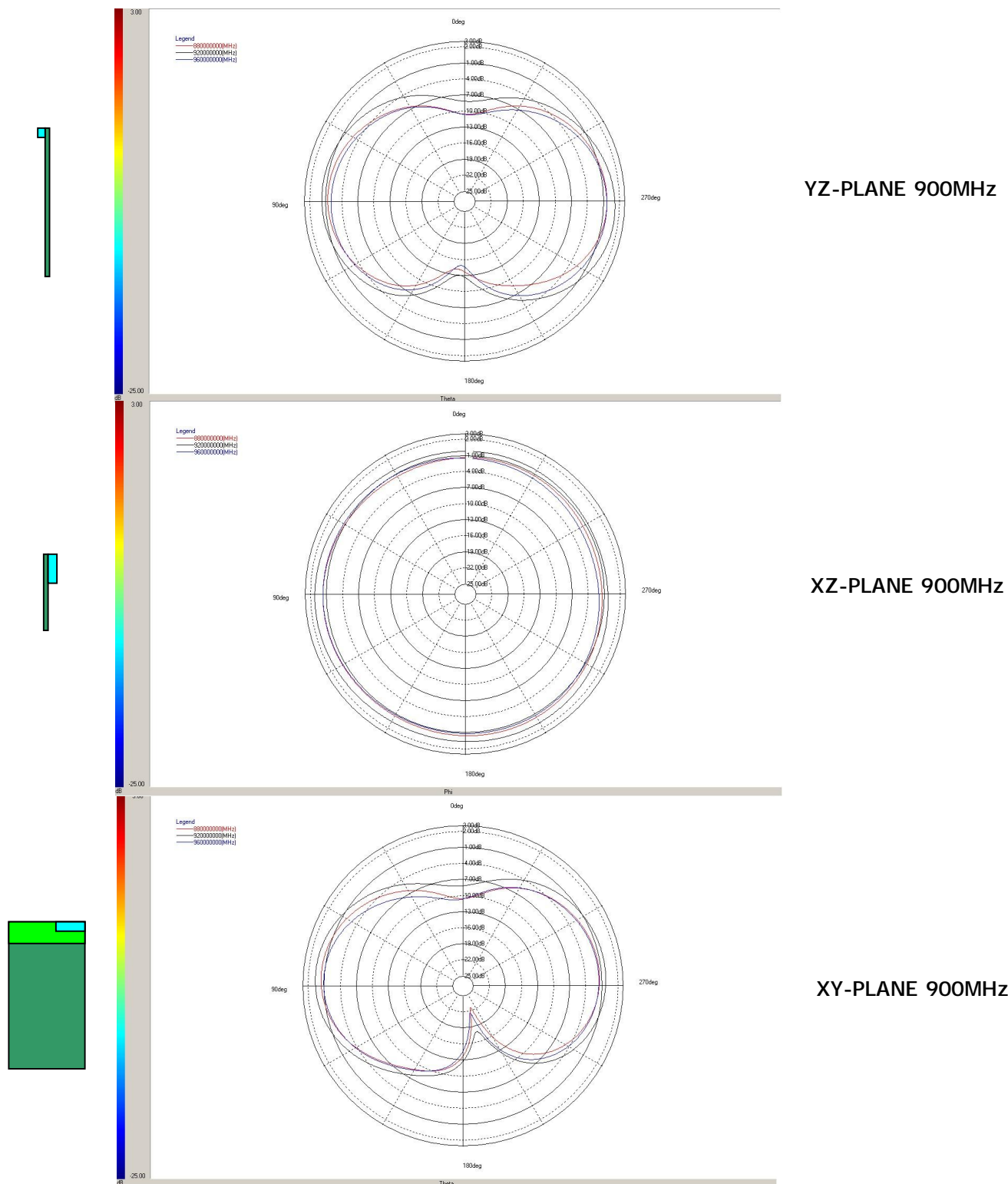

### Typical Free Space Radiation Patterns for PCN1800 Band

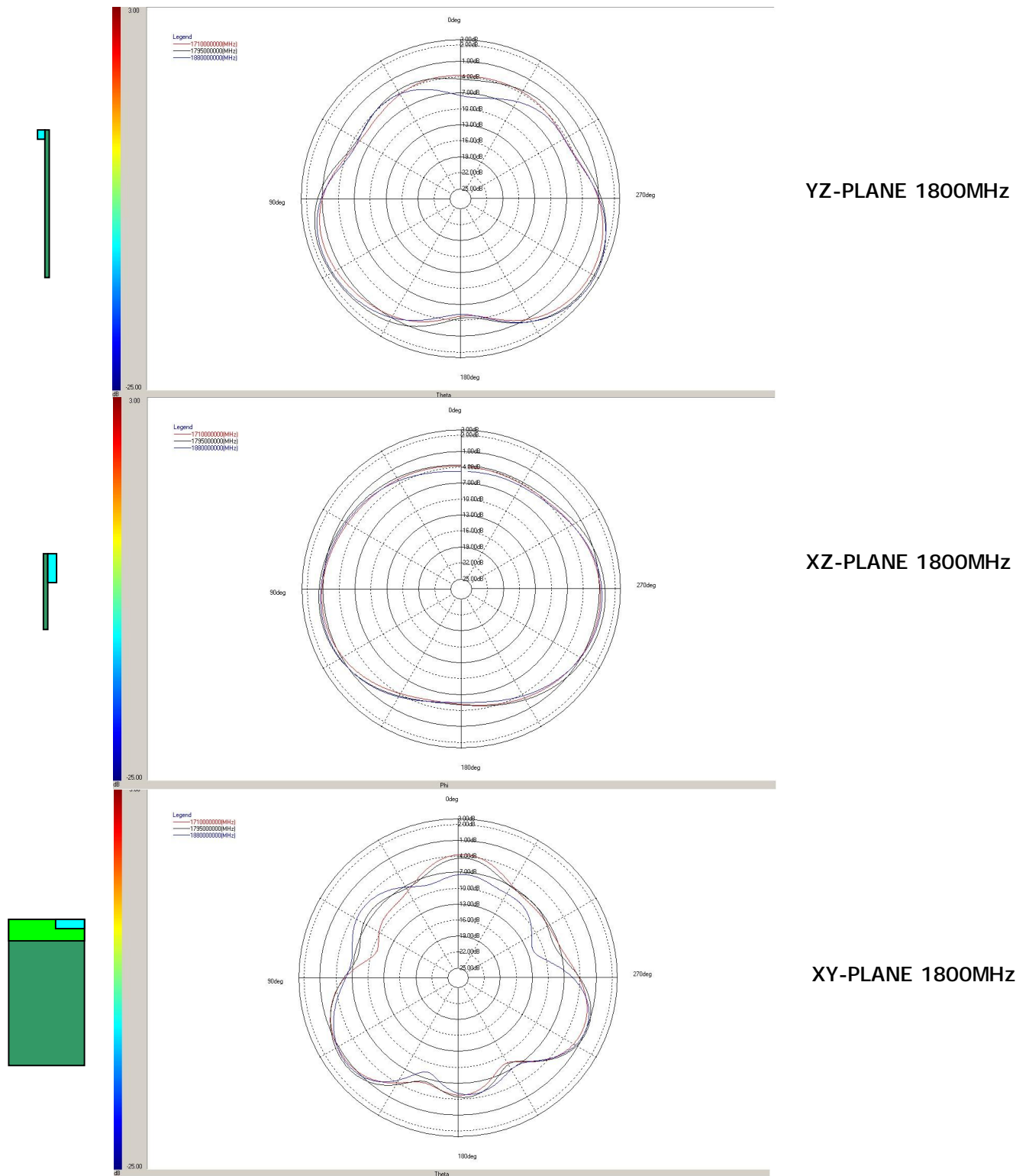

# Ceramic Chip Antenna

## Packing

### General

Tape and reel packing is used. Carrier tape, reel and box dimensions are presented in following pictures.

### Carrier tape

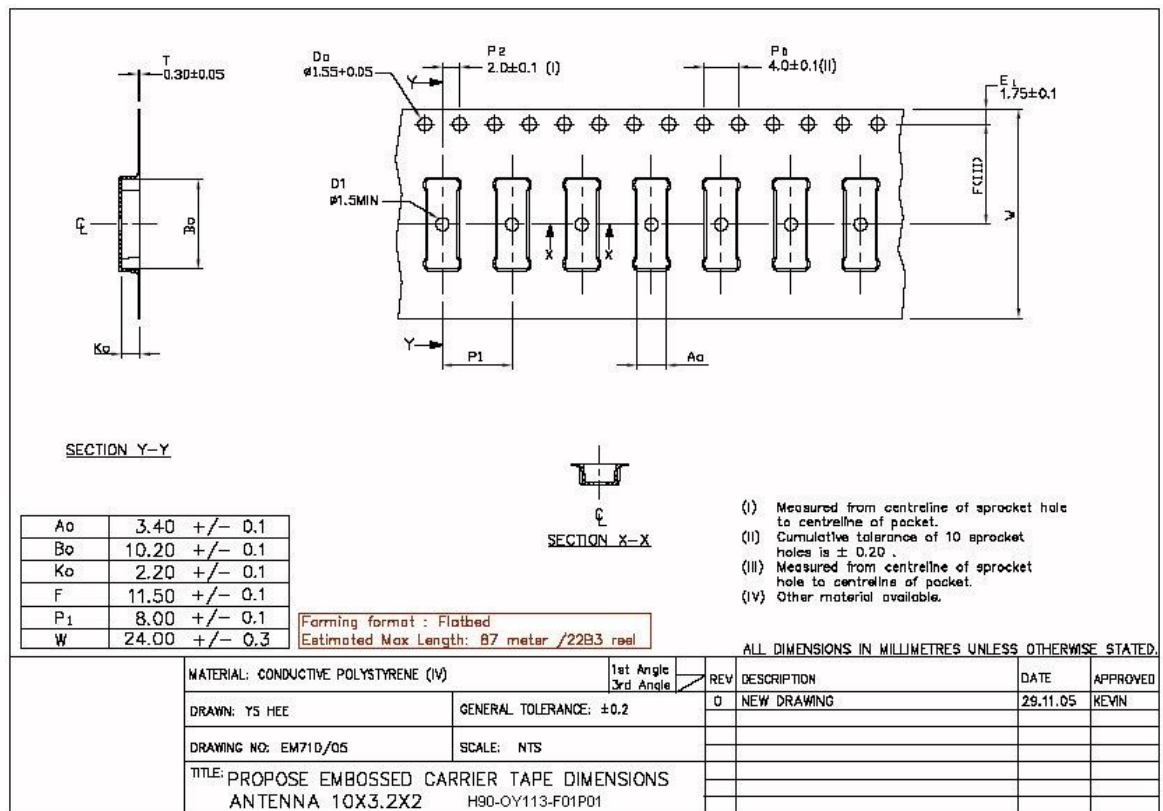

### Block orientation

Antenna soldering pads facing down to the bottom of the carrier tape.

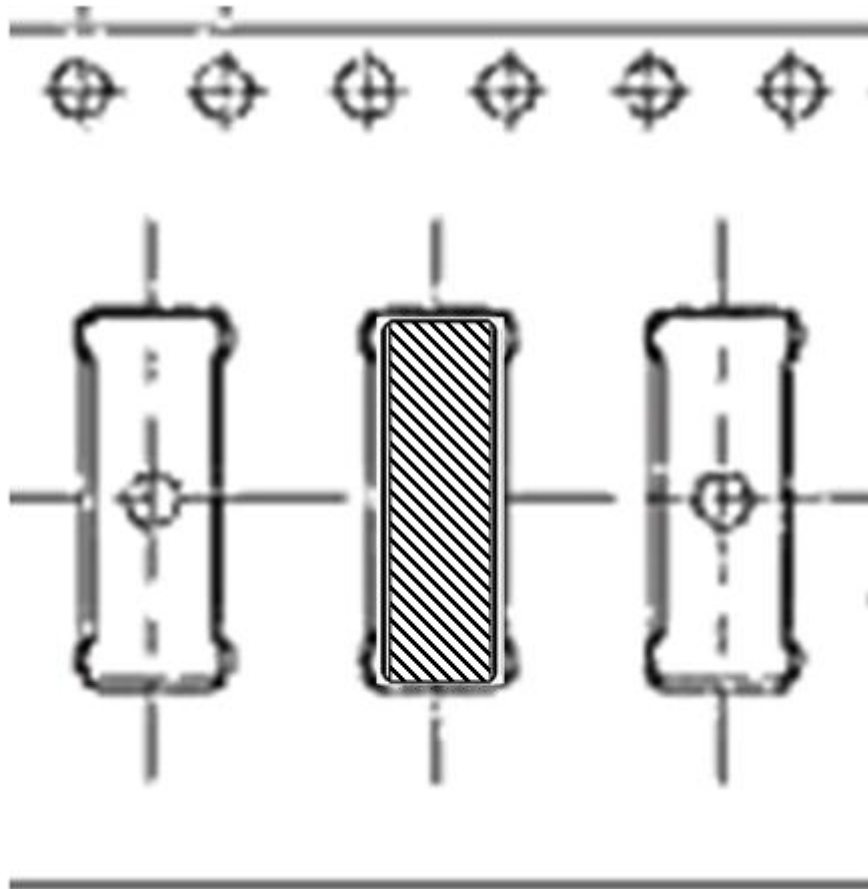

#### Pulse Finland Oy

Takatie 6  
90440 Kempele, Finland  
Tel: +358 207 935 500  
Fax: +358 207 935 501

Domicile: Kempele  
Business ID: 1933992-8  
[firstname.lastname@pulseeng.com](mailto:firstname.lastname@pulseeng.com)  
[www.pulseeng.com/antennas](http://www.pulseeng.com/antennas)



© 2006. All Rights Reserved.

### Packing form

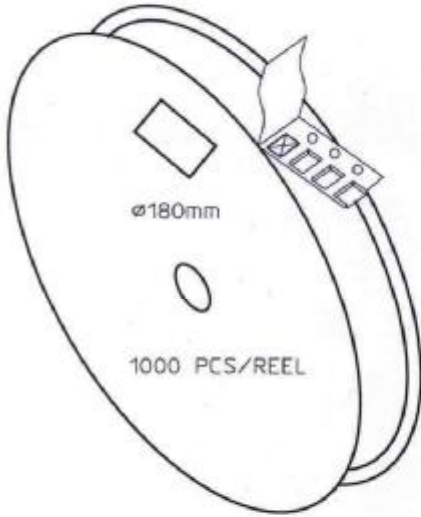
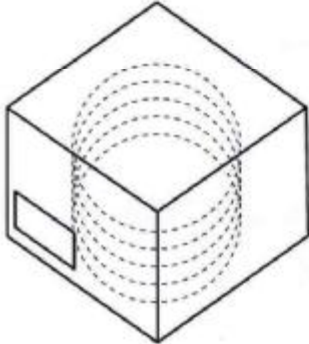
CARRIER TAPE H85-00168  
width=24,00 depth=2.20  
COVER TAPE H85-00159  
width=21.20

LENGTH OF TAPE:

- Leader section: min 350 mm before component section
- Trailer section: min 40 mm after component section.

Empty part cavities at leader and trailer section of the tape must be sealed with top cover tape.

BOX H85-00128 (182x182x125)	1 pcs
- LABEL	1 pcs/BOX
REEL H85-00160 (D180, W28)	4 pcs
- REEL LABEL	1 pcs/REEL

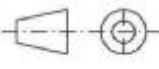
MATERIAL			
HANDLINGS			
		RATIO	DRWN 160107 PeHa H
			DGNER
			CHKD
			APPRD
			APPRD BY
PRODUCT	H90-OY113-F01P01		C
DENOMINATION	PACKING FORM		B
			A
		VERSION	MOD/DATE/NAME

# Ceramic Chip Antenna

## Mechanical Outline

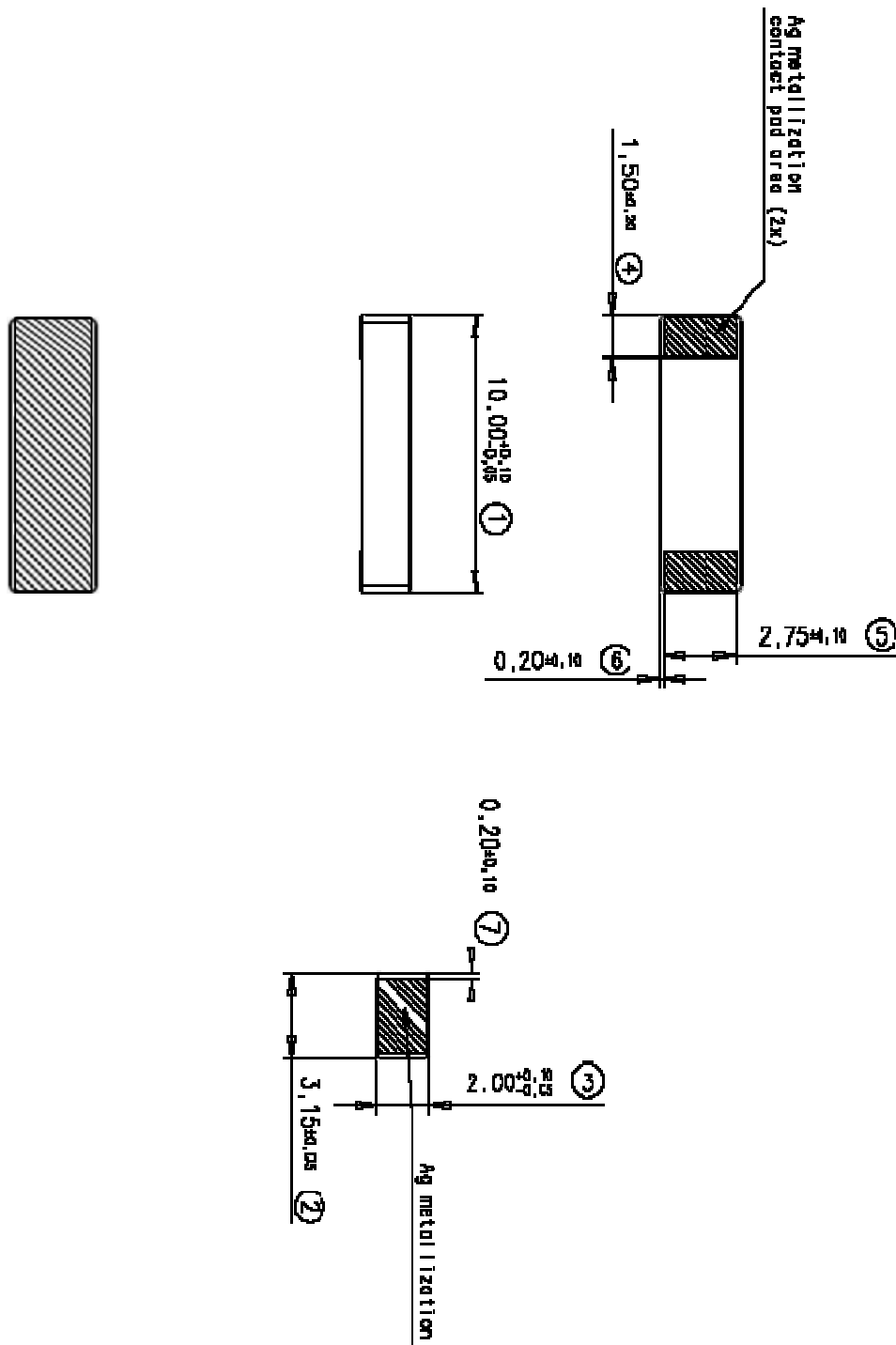

**Pulse Finland Oy**

Takatie 6  
 90440 Kempele, Finland  
 Tel: +358 207 935 500  
 Fax: +358 207 935 501

Domicile: Kempele  
 Business ID: 1933992-8  
[firstname.lastname@pulseeng.com](mailto:firstname.lastname@pulseeng.com)  
[www.pulseeng.com/antennas](http://www.pulseeng.com/antennas)



© 2006. All Rights Reserved.



For More Information, please contact:

**Pulse Finland Oy**

Takatie 6

Fin-90440 Kempele

Finland

Tel. +358 207 935 500

Fax +358 207 935 501 (sales)

Domicile: Kempele

Business ID: 1933992-8

[firstname.lastname@pulseeng.com](mailto:firstname.lastname@pulseeng.com)

[www.pulseeng.com/antennas](http://www.pulseeng.com/antennas)

**Pulse World Wide Headquarters**

12220 World Trade Drive

San Diego, CA 92128

U.S.A

Tel. +1 858 674 8100

Fax +1 858 674 826

[www.pulseeng.com](http://www.pulseeng.com)

This is a "Preliminary" product application notes. Products mentioned on this application notes are in development and in the process of being qualified. These products are not fully released nor are they in production. Features, specifications and performance of products offered are subject to change without notice. Other brand and product names mentioned herein may be products and/or registered trademarks of their respective ones. For current info on this product, please contact the Pulse San Diego office.

© Copyright, 2006. Pulse Finland Oy. All rights reserved.

**Pulse Finland Oy**

Takatie 6

90440 Kempele, Finland

Tel: +358 207 935 500

Fax: +358 207 935 501

Domicile: Kempele

Business ID: 1933992-8

[firstnamelastname@pulseeng.com](mailto:firstname.lastname@pulseeng.com)

[www.pulseeng.com/antennas](http://www.pulseeng.com/antennas)



© 2006. All Rights Reserved<sub>1-7</sub>

单击下面可查看定价，库存，交付和生命周期等信息

[>>Pulse\(普思\)](#)