

Features:

- 3 in 1 solution on a ceramic chip with two separate feeds.
- Need smaller antenna space on PCB to integrate GNSS, Dual WiFi and DSRC bands
- Compact Size (L x W x H) 10 x 3.2 x 1.5mm.
- Fully SMD compatible

Applications:

- GNSS(1560-1610MHz)
- GPS, Glonass, Beidou
- IEEE 802.11 a/b/g/n compliant 2.4 and 5GHz. (2400-2485/ 4900-5850MHz)
- DSRC (5850-5925MHz)
- Mobile navigation device

All dimensions are in mm / inches

Issue: 2042

In the effort to improve our products, we reserve the right to make changes judged to be necessary.

CONFIDENTIAL AND PROPRIETARY INFORMATION

This document contains confidential and proprietary information of Pulse Electronics, Inc. (Pulse) and is protected by copyright, trade secret and other state and federal laws. Its receipt or possession does not convey any rights to reproduce, disclose its contents, or to manufacture, use or sell anything it may describe. Reproduction, disclosure or use without specific written authorization of Pulse is strictly forbidden.

For more information:

Pulse Worldwide Headquarters
15255 Innovation Drive #100
San Diego, CA 92128
USA
Tel:1-858-674-8100

Pulse/Larsen Antennas
18110 SE 34th St Bldg 2 Suite 250
Vancouver, WA 98683
USA
Tel: 1-360-944-7551

Europe Headquarters
Pulse GmbH & Do, KG
Zeppelinstrasse 15
Herrenberg, Germany

Pulse (Suzhou) Wireless Products Co, Inc.
99 Huo Ju Road(#29 Bldg,4th Phase
Suzhou New District
Jiangsu Province, Suzhou 215009 PR China
Tel: 86 512 6807 9998

ELECTRICAL SPECIFICATIONS

Frequency, Port 1	1.560-1.610 GHZ
Frequency, Port 2	2.4-2.485/ 4.9-5.925 GHz
Normal Impedance	50 Ohm
Return Loss, Port 1	<2.5:1
Return Loss, Port 1	<2:1at low band <2.8:1 at high band
Efficiency (Typ.), Port 1	65 %
Efficiency (Typ.), Port 2	70/ 55 %
Peak Gain, Port 1	1.5 dBi
Peak Gain, Port 2	1.5/ 3.5 dBi
Isolation (Min.) at 1.560-1.610 GHz	20 dB
Isolation (Min.) at 2.4-2.485 GHz	18 dB
Isolation (Min.) at 4.9-5.925 GHz	22 dB
Polarization	Linear
Interface	SMD Mount

Description: GNSS-DUAL WIFI-DSRC ANT**PART NUMBER:** W3095**MECHANICAL SPECIFICATIONS**

Block material	Dielectric ceramic
Plating material	Ag
Weight	0.24 g
RoHS Compliant Product	
Tape and reel packing	
Lead free materials	
Lead free soldering compatible	
Vibration test	According to AEC-Q200-Rev-D MIL-STD-202 Method 204, 5g's for 20 min., 12 cycles each of 3 orientations. Note: USE 8" x 5" PCB .031" thick 7 secure points on one long side and 2 secure points at corners of opposite sides. Parts mounted within 2" from any secure point. Test from 10-2000 Hz.
Moisture sensitivity level	MSL 1

ENVIRONMENTAL SPECIFICATIONS

Operating temperature	-30 to +80° C
-----------------------	---------------

a YAGEO company

Description: GNSS-DUAL WIFI-DSRC ANT

Series: CERAMIC CHIP

PART NUMBER: W3095

MECHANICAL DRAWING

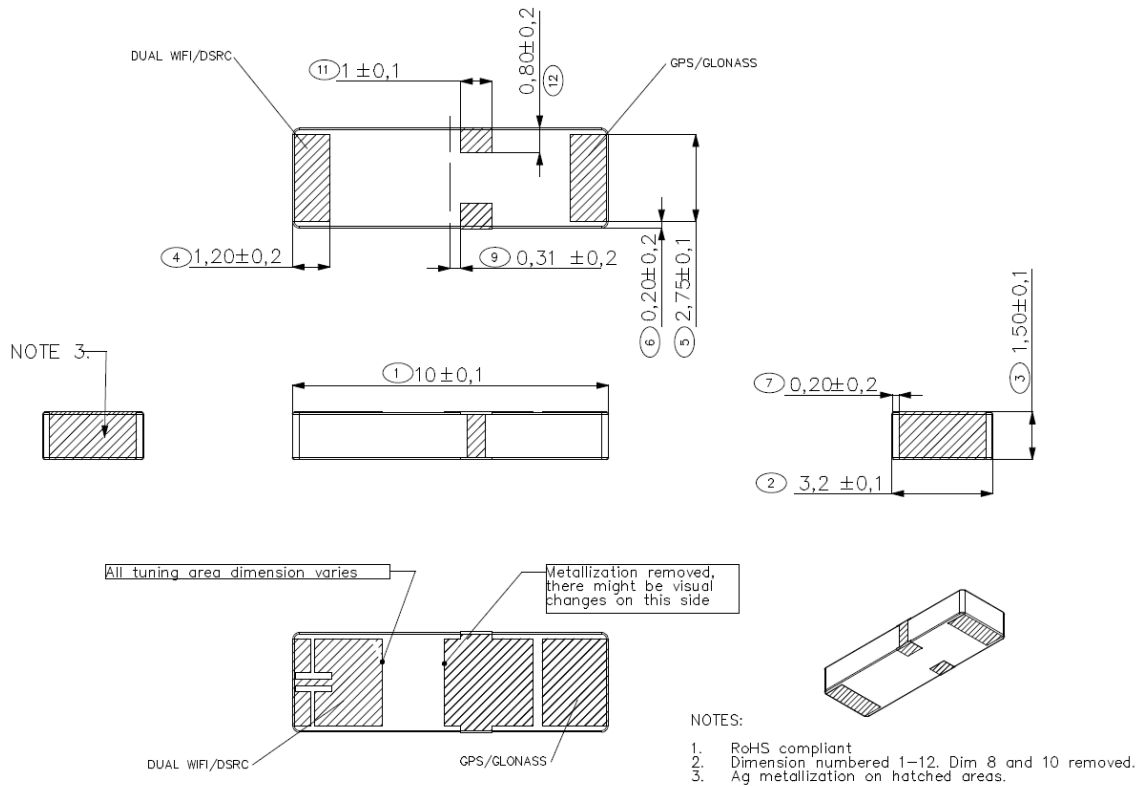

Dimensions: (mm)

Details of antenna pad dimension on the bottom in mm.

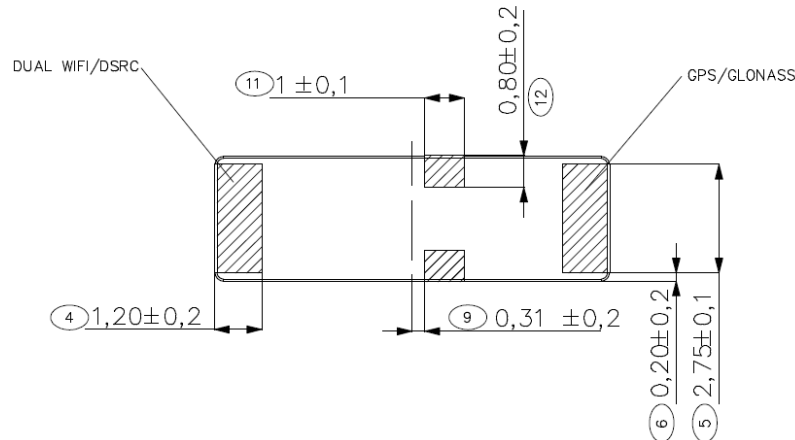

Issue: 2042

In the effort to improve our products, we reserve the right to make changes judged to be necessary.

CONFIDENTIAL AND PROPRIETARY INFORMATION

This document contains confidential and proprietary information of Pulse Electronics, Inc. (Pulse) and is protected by copyright, trade secret and other state and federal laws. Its receipt or possession does not convey any rights to reproduce, disclose its contents, or to manufacture, use or sell anything it may describe. Reproduction, disclosure or use without specific written authorization of Pulse is strictly forbidden.

a YAGEO company

Series: CERAMIC CHIP

Description: GNSS-DUAL WIFI-DSRC ANT

PART NUMBER: W3095

OTHER SPECIFICATIONS

PCB Layout Recommendation

Top Side

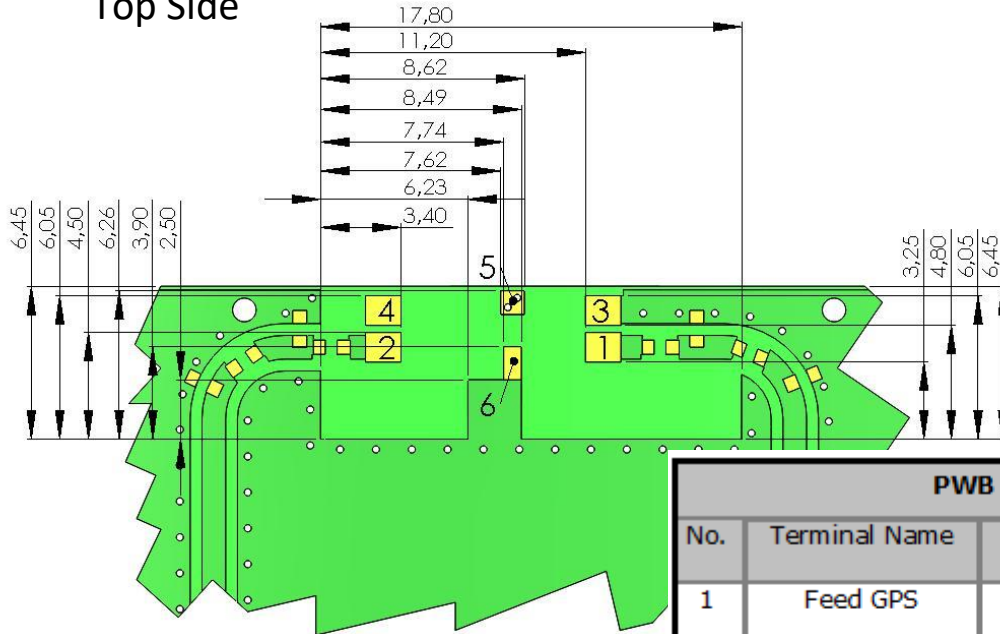

PWB features

No.	Terminal Name	Terminal Dimensions
1	Feed GPS	1.25 x 1.50 mm
2	Feed 2,4-5,925GHZ	1.25 x 1.50 mm
3	GND	1.25 x 1.50 mm
4	Support pad	1.25 x 1.50 mm
5	GND	1.00 x 1.00 mm
6	GND	1.40x 0.75 mm

Bottom Side

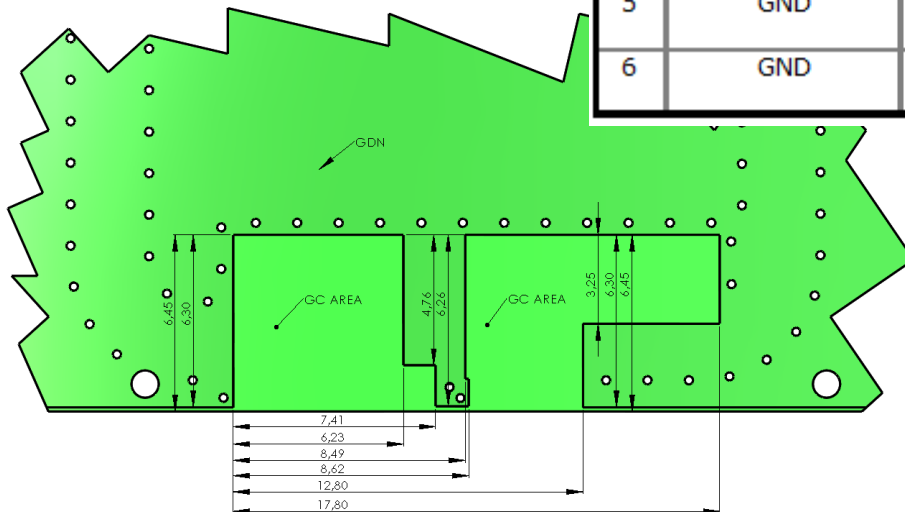

Issue: 2042

In the effort to improve our products, we reserve the right to make changes judged to be necessary.

CONFIDENTIAL AND PROPRIETARY INFORMATION

This document contains confidential and proprietary information of Pulse Electronics, Inc. (Pulse) and is protected by copyright, trade secret and other state and federal laws. Its receipt or possession does not convey any rights to reproduce, disclose its contents, or to manufacture, use or sell anything it may describe. Reproduction, disclosure or use without specific written authorization of Pulse is strictly forbidden.

OTHER SPECIFICATIONS

Antenna Alignment on PCB Layout

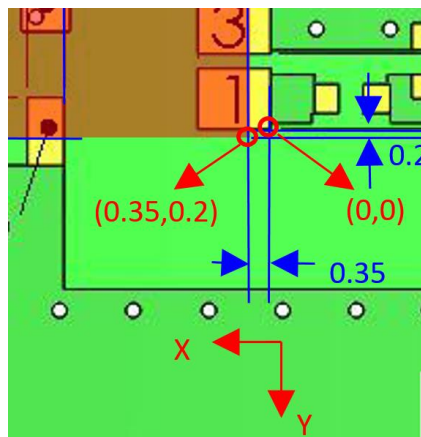
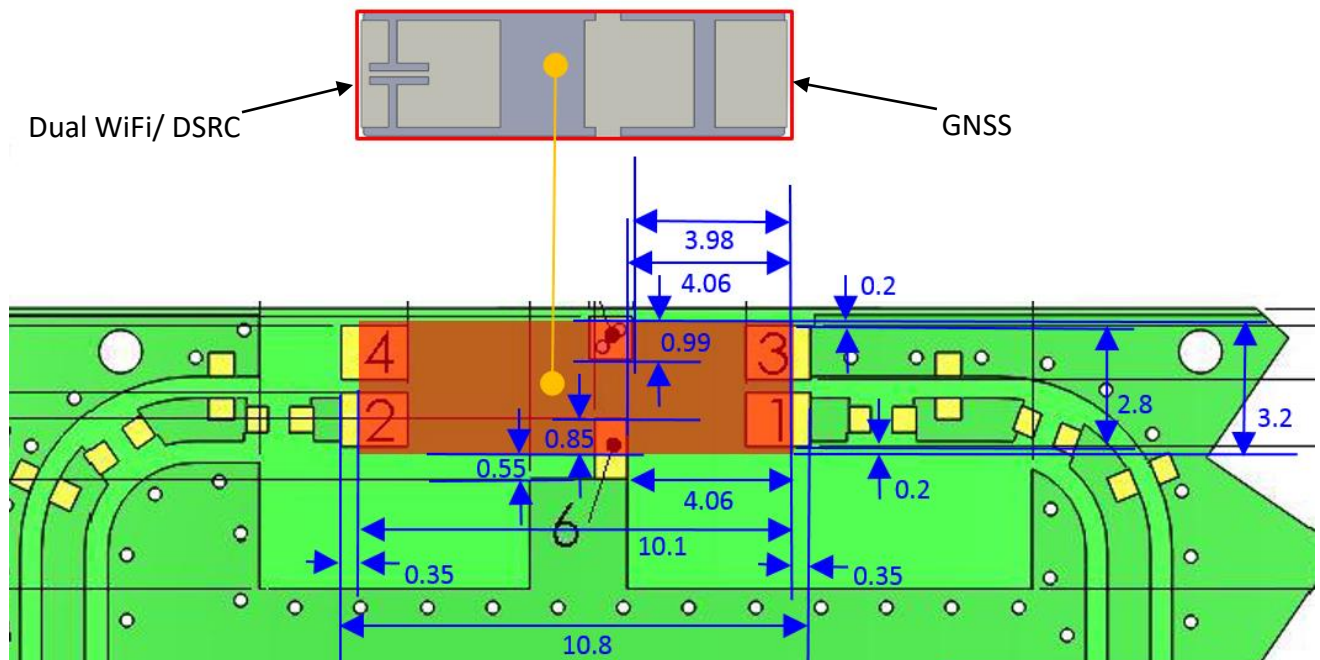

a YAGEO company

Description: GNSS-DUAL WIFI-DSRC ANT

Series: CERAMIC CHIP

PART NUMBER: W3095

OTHER SPECIFICATIONS

Suggested Matching on PCB

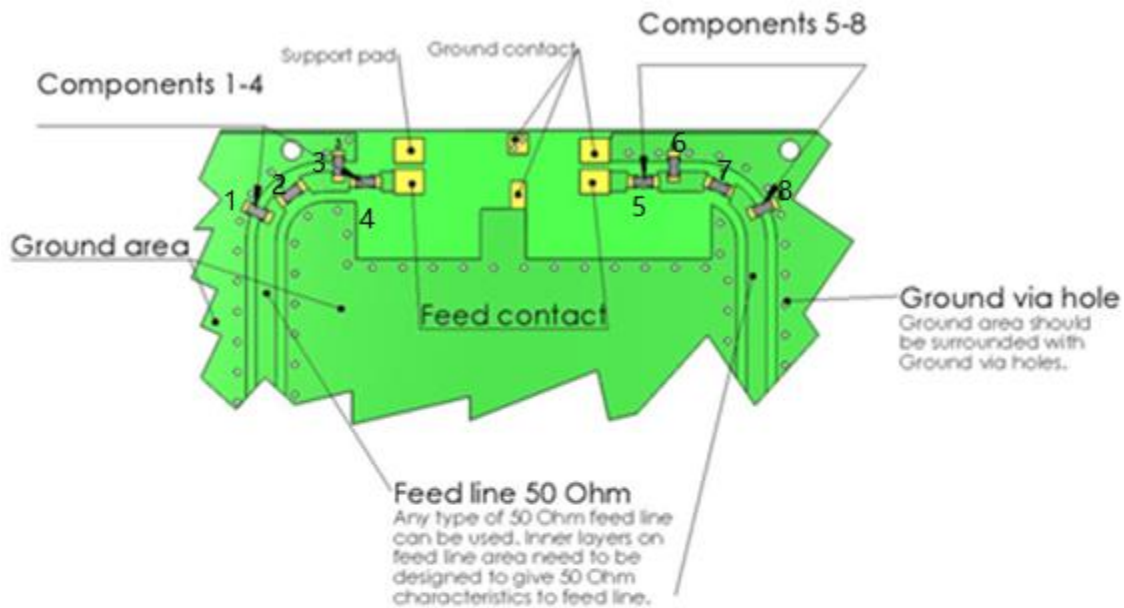

Antenna	Component NO.	Value
2,4-5,85GHz	1	Not in use
2,4-5,85GHz	2	0 Ohm
2,4-5,85GHz	3	2,2nH
2,4-5,85GHz	4	1,2pF
GNSS	5	0 Ohm
GNSS	6	1,8pF
GNSS	7	0 Ohm
GNSS	8	Not in use

Issue: 2042

In the effort to improve our products, we reserve the right to make changes judged to be necessary.

CONFIDENTIAL AND PROPRIETARY INFORMATION

This document contains confidential and proprietary information of Pulse Electronics, Inc. (Pulse) and is protected by copyright, trade secret and other state and federal laws. Its receipt or possession does not convey any rights to reproduce, disclose its contents, or to manufacture, use or sell anything it may describe. Reproduction, disclosure or use without specific written authorization of Pulse is strictly forbidden.

Downloaded From Oneyac.com

CHARTS

Typical GNSS antenna Return Loss



Typical WIFI antenna Return Loss



Issue: 2042

In the effort to improve our products, we reserve the right to make changes judged to be necessary.

CONFIDENTIAL AND PROPRIETARY INFORMATION

This document contains confidential and proprietary information of Pulse Electronics, Inc. (Pulse) and is protected by copyright, trade secret and other state and federal laws. Its receipt or possession does not convey any rights to reproduce, disclose its contents, or to manufacture, use or sell anything it may describe. Reproduction, disclosure or use without specific written authorization of Pulse is strictly forbidden.

CHARTS

Typical Isolation

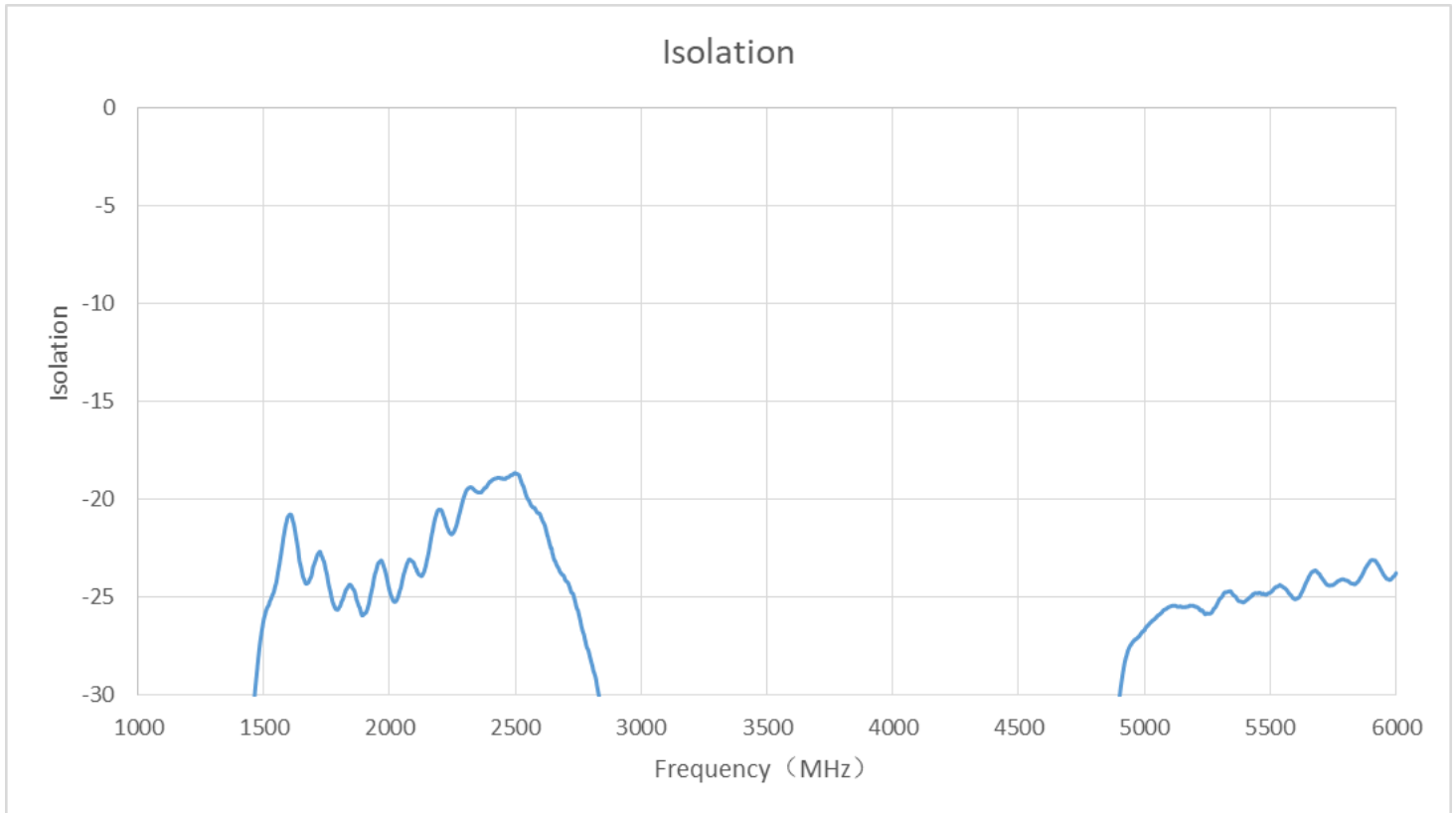

a YAGEO company

Series: CERAMIC CHIP

Description: GNSS-DUAL WIFI-DSRC ANT

PART NUMBER: W3095

CHARTS

Typical Antenna Total Efficiency

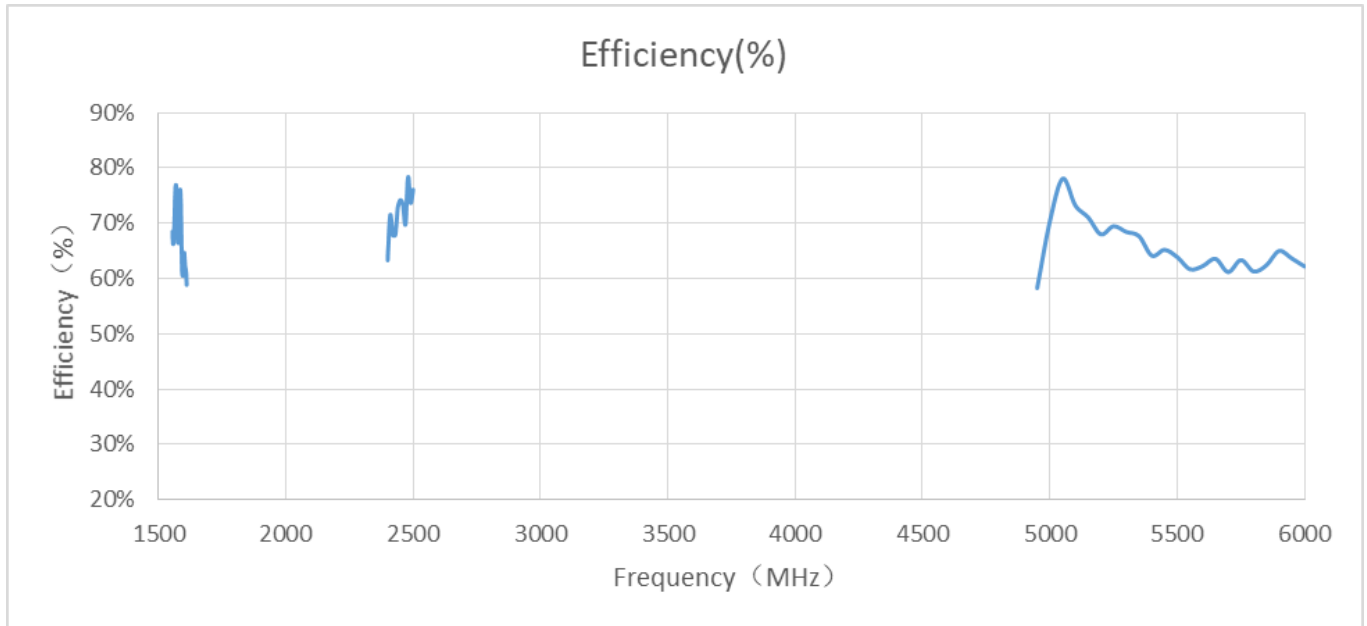

Typical Antenna Peak Gain

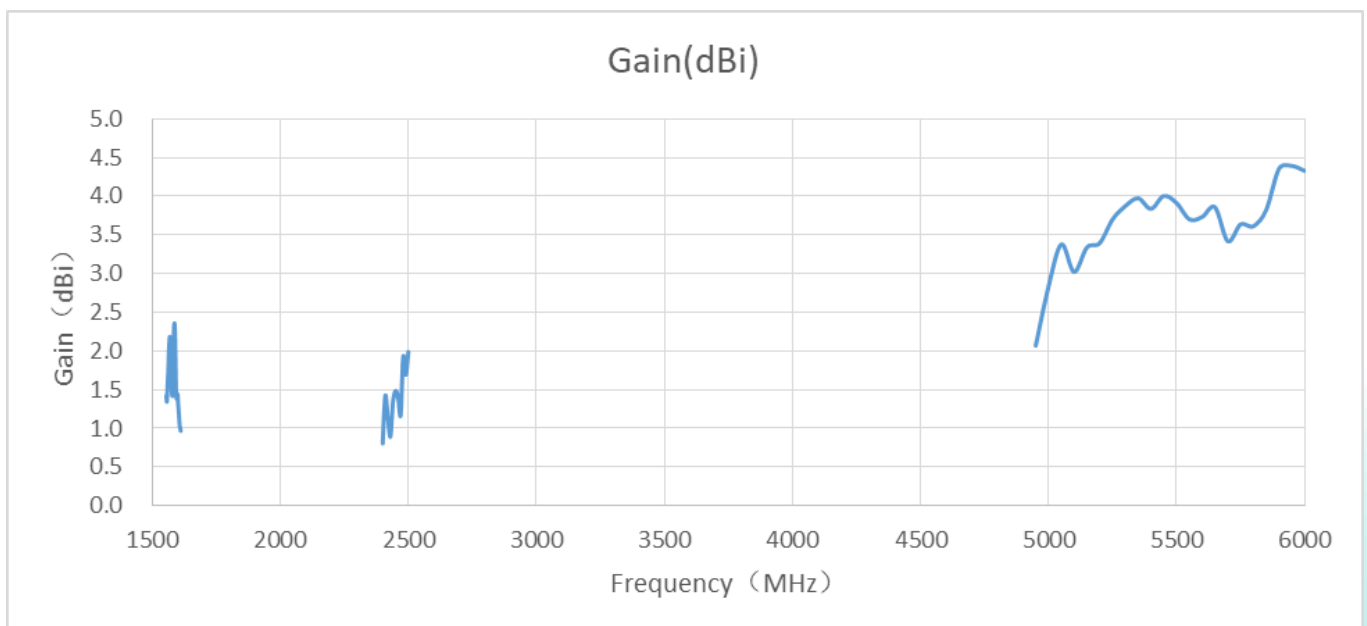

Issue: 2042

In the effort to improve our products, we reserve the right to make changes judged to be necessary.

CONFIDENTIAL AND PROPRIETARY INFORMATION

This document contains confidential and proprietary information of Pulse Electronics, Inc. (Pulse) and is protected by copyright, trade secret and other state and federal laws. Its receipt or possession does not convey any rights to reproduce, disclose its contents, or to manufacture, use or sell anything it may describe. Reproduction, disclosure or use without specific written authorization of Pulse is strictly forbidden.

CHARTS

Typical free space radiation pattern—GNSS

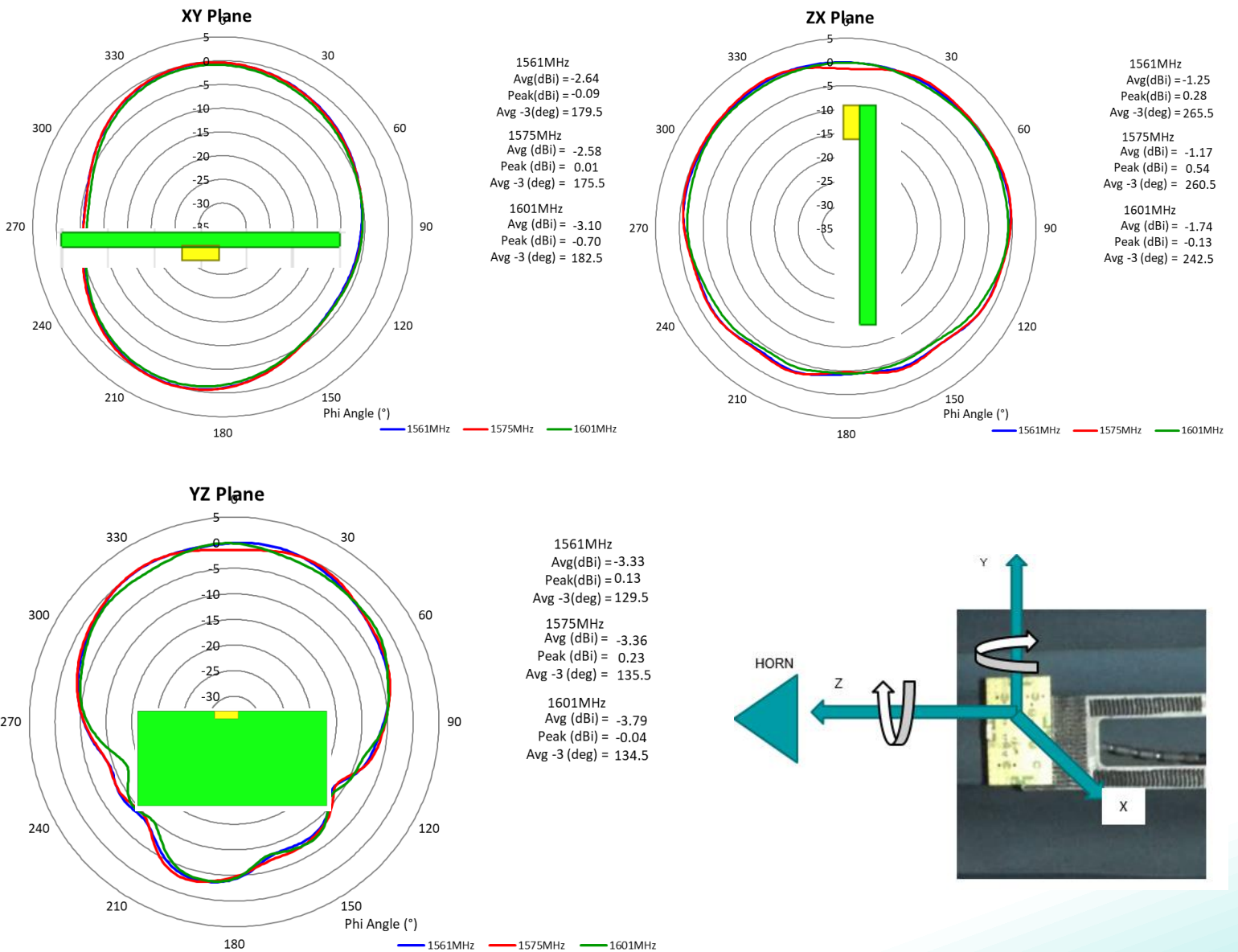

Issue: 2042

In the effort to improve our products, we reserve the right to make changes judged to be necessary.

CONFIDENTIAL AND PROPRIETARY INFORMATION

This document contains confidential and proprietary information of Pulse Electronics, Inc. (Pulse) and is protected by copyright, trade secret and other state and federal laws. Its receipt or possession does not convey any rights to reproduce, disclose its contents, or to manufacture, use or sell anything it may describe. Reproduction, disclosure or use without specific written authorization of Pulse is strictly forbidden.

CHARTS

Typical free space radiation pattern—2.4G

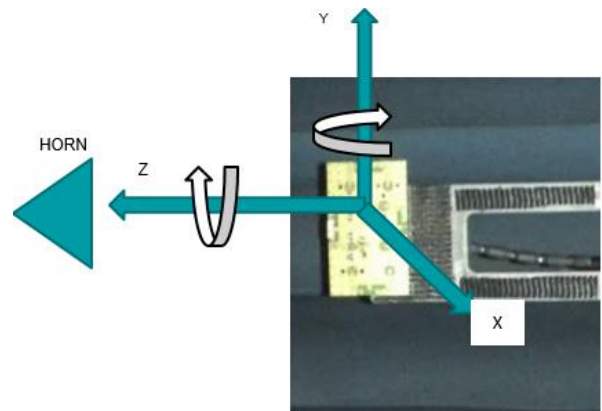
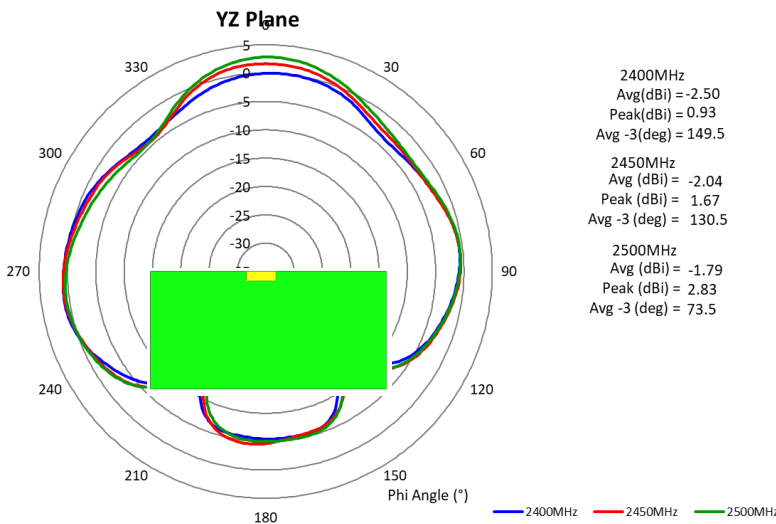
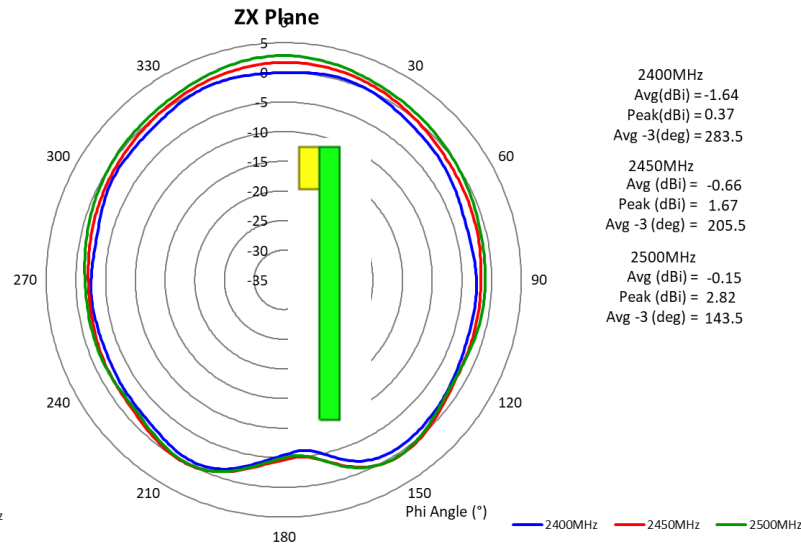
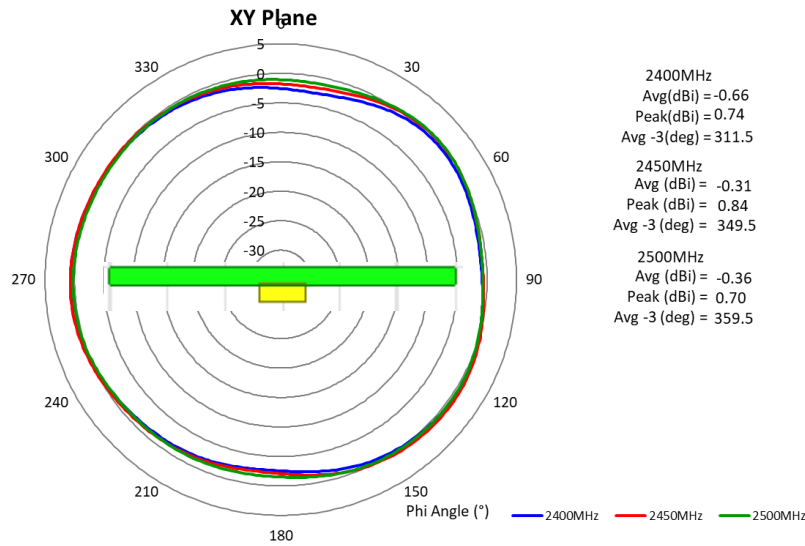

Issue: 2042

In the effort to improve our products, we reserve the right to make changes judged to be necessary.

CONFIDENTIAL AND PROPRIETARY INFORMATION

This document contains confidential and proprietary information of Pulse Electronics, Inc. (Pulse) and is protected by copyright, trade secret and other state and federal laws. Its receipt or possession does not convey any rights to reproduce, disclose its contents, or to manufacture, use or sell anything it may describe. Reproduction, disclosure or use without specific written authorization of Pulse is strictly forbidden.

CHARTS

Typical free space radiation pattern—5G

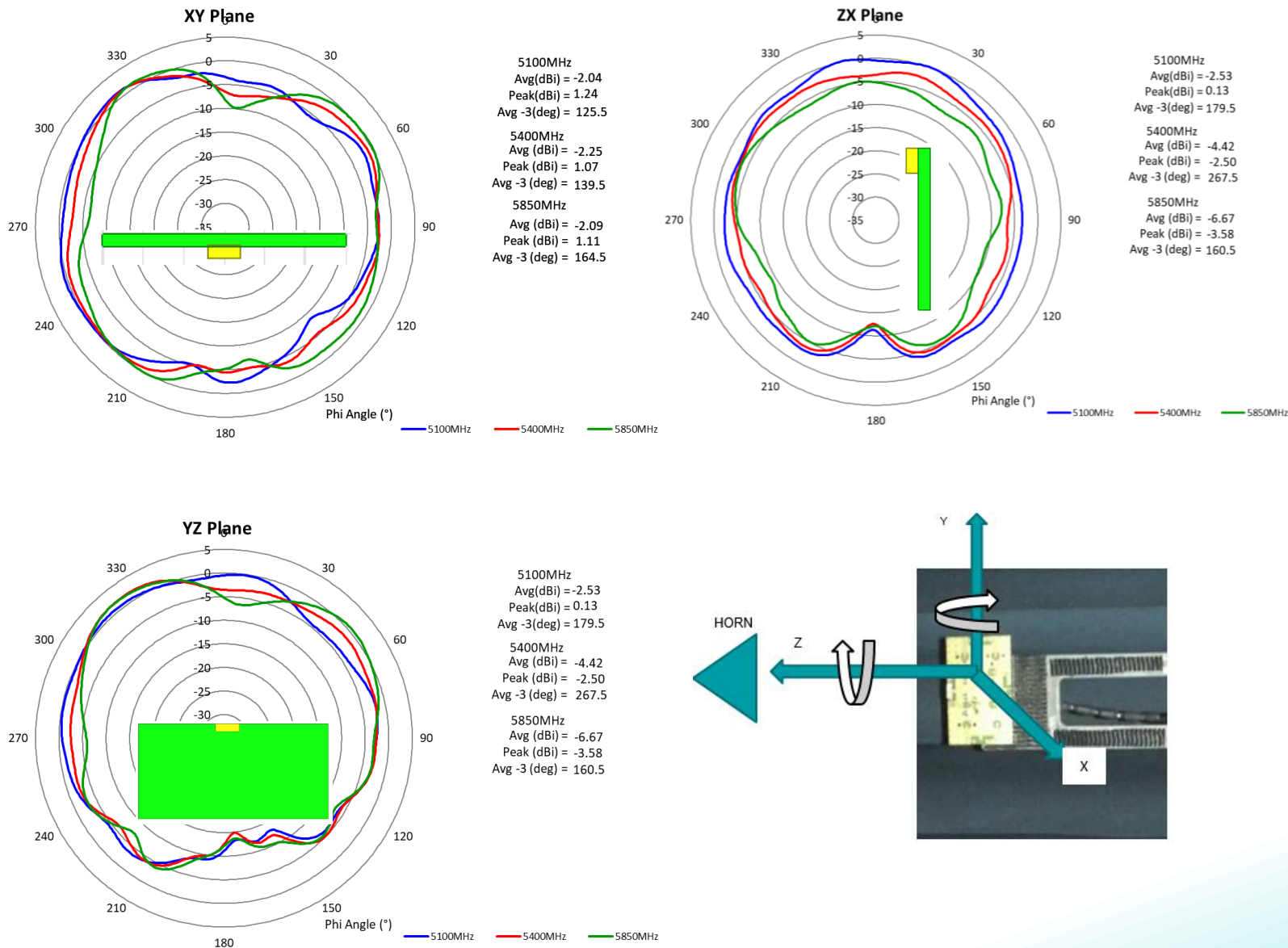

Issue: 2042

In the effort to improve our products, we reserve the right to make changes judged to be necessary.

CONFIDENTIAL AND PROPRIETARY INFORMATION

This document contains confidential and proprietary information of Pulse Electronics, Inc. (Pulse) and is protected by copyright, trade secret and other state and federal laws. Its receipt or possession does not convey any rights to reproduce, disclose its contents, or to manufacture, use or sell anything it may describe. Reproduction, disclosure or use without specific written authorization of Pulse is strictly forbidden.

PACKAGING

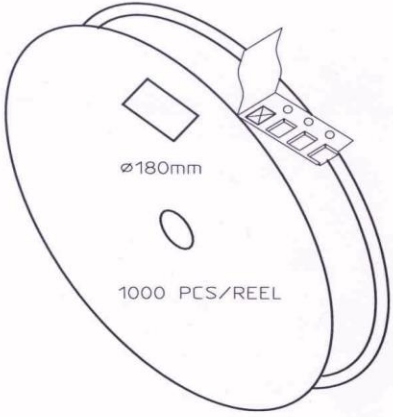

CARRIER TAPE H85-00188
 width=24,00 depth=2.20
 COVER TAPE H85-00159
 width=21.20

LENGTH OF TAPE:

- Leader section: min 350 mm before component section
- Trailer section: min 40 mm after component section.

Empty part cavities at leader and trailer section of the tape must be sealed with top cover tape.

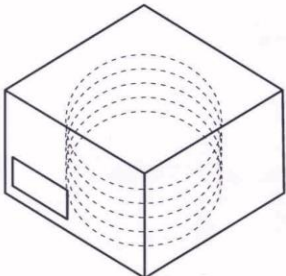

BOX H85-00128 (182x182x125)	1 pcs
- LABEL	1 pcs/BOX
REEL H85-00160 (D180, W28)	4 pcs
- REEL LABEL	1 pcs/REEL

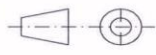
MATERIAL	
HANDLINGS	
 	RATIO
	DRWN 160107 PeHa H
PRODUCT H90-OY113-F01P01	DGNER G
	CHKD F
	APPRD E
	APPRD BY D
	C
DENOMINATION PACKING FORM	B
	A
	VERSION MOD/DATE/NAME

Block Orientation

Antenna soldering pads facing down to the bottom of the carrier tape

Top view of the carrier tape

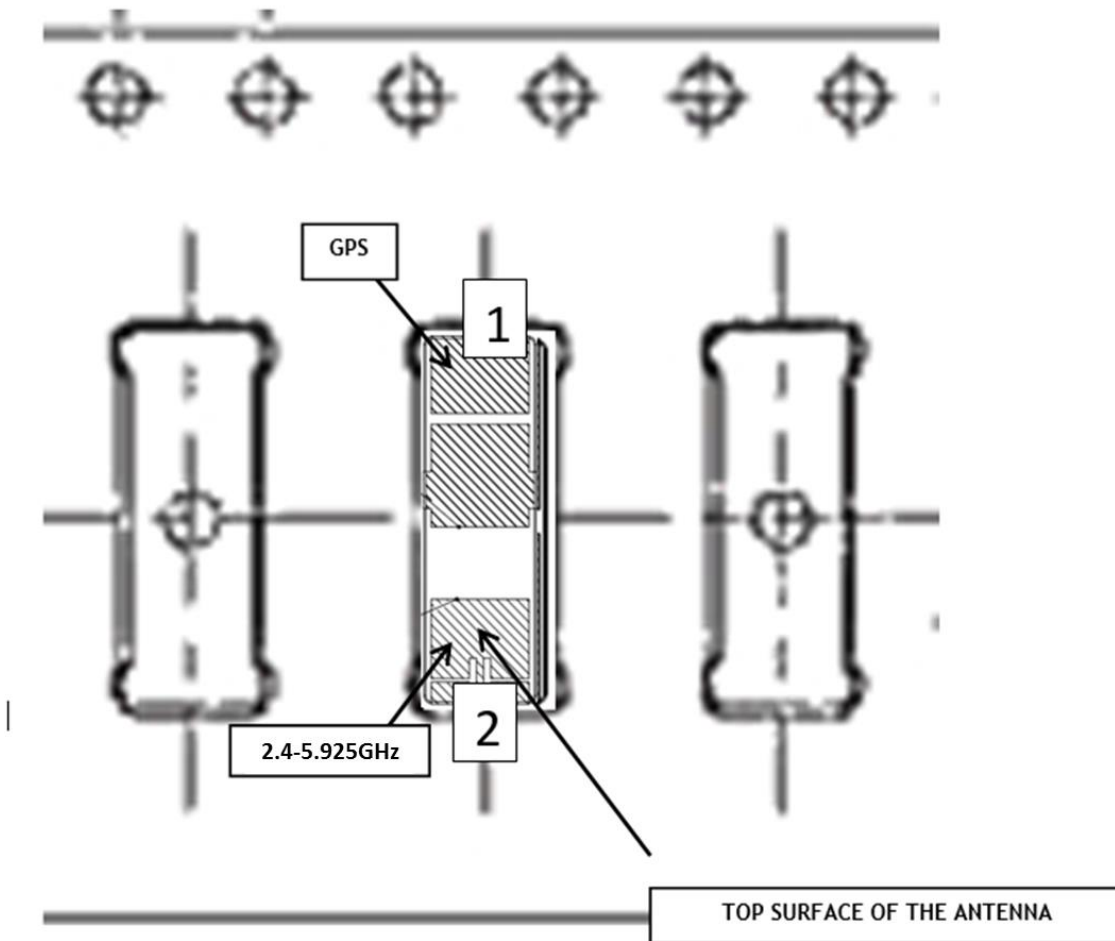

单击下面可查看定价，库存，交付和生命周期等信息

[>>Pulse\(普思\)](#)