

Description: LTE698-960/1710-2690MHzSMA

Series: ICEBLADE

PART NUMBER: ICEBLADELS



Features:

- 690-2690MHz
- Gain 1.6/2.5dBi
- 90 degree swivel
- SMA connector
- Translucent visually appealing radome

Applications:

- LTE radios
- Gateways
- Set top boxes
- M-to-M, IoT

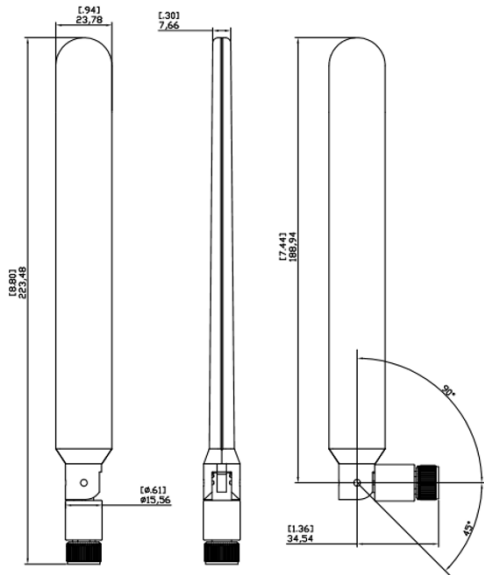

All dimensions are in mm / inches

Issue:1747

In the effort to improve our products, we reserve the right to make changes judged to be necessary.

CONFIDENTIAL AND PROPRIETARY INFORMATION

This document contains confidential and proprietary information of Pulse Electronics, Inc. (Pulse) and is protected by copyright, trade secret and other state and federal laws. Its receipt or possession does not convey any rights to reproduce, disclose its contents, or to manufacture, use or sell anything it may describe. Reproduction, disclosure or use without specific written authorization of Pulse is strictly forbidden.

For more information:

Pulse Worldwide Headquarters
12220 World Trade Drive
San Diego, CA 92128
USA
Tel:1-858-674-8100

Pulse/Larsen Antennas
3611 NE 112th Ave
Vancouver, WA 98682
USA
Tel: 1-360-944-7551

Europe Headquarters
Pulse GmbH & Do, KG
Zeppelinstrasse 15
Herrenberg, Germany

Pulse (Suzhou) Wireless Products Co, Inc.
99 Huo Ju Road(#29 Bldg,4th Phase
Suzhou New District
Jiangsu Province, Suzhou 215009 PR China
Tel: 86 512 6807 9998



Description: LTE698-960/1710-2690MHzSMA

Series: ICEBLADE

PART NUMBER: ICEBLADELS

ELECTRICAL SPECIFICATIONS

Frequency	698-960/1710-2690	MHz
Nominal Impedance	50	Ω
VSWR	2.5 :1	
Average Efficiency(698-960MHz)	37	%
Average Efficiency(1710-2690MHz)	60	%
Peak Gain (698-960MHz)	1.6	dBi +/- 1 dB
Peak Gain(1710-2690MHz)	2.5	dBi +/- 1 dB
Polarization:	linear	
Power withstanding	3	W
Connector type	SMA	

Issue:1747

In the effort to improve our products, we reserve the right to make changes judged to be necessary.

CONFIDENTIAL AND PROPRIETARY INFORMATION

This document contains confidential and proprietary information of Pulse Electronics, Inc. (Pulse) and is protected by copyright, trade secret and other state and federal laws. Its receipt or possession does not convey any rights to reproduce, disclose its contents, or to manufacture, use or sell anything it may describe. Reproduction, disclosure or use without specific written authorization of Pulse is strictly forbidden.

Description: LTE698-960/1710-2690MHzSMA

Series: ICEBLADE

PART NUMBER: ICEBLADELS

MECHANICAL SPECIFICATIONS

Plastic radome	PC945A
Color	Clarity
Flammability(Radome)	UL94 V-0
Weight	45.4g
Positions	0°, 45° & 90°
Overall length	8.8 INCHES
Fixing system	° ± 2 °
Azimuth adjustment	° ± 4°
Elevation adjustment	° ± 4°

ENVIRONMENTAL SPECIFICATIONS

Operating temperature	-30/+70° C
Temperature	
Stationary	-40/+85° C
Cyclic	Rate 5°C/min, 16 hours
Humidity	
Stationary	95%@ 25° C
Cyclic	12 hours
Salt mist	96 hours

Issue:1747

In the effort to improve our products, we reserve the right to make changes judged to be necessary.

CONFIDENTIAL AND PROPRIETARY INFORMATION

This document contains confidential and proprietary information of Pulse Electronics, Inc. (Pulse) and is protected by copyright, trade secret and other state and federal laws. Its receipt or possession does not convey any rights to reproduce, disclose its contents, or to manufacture, use or sell anything it may describe. Reproduction, disclosure or use without specific written authorization of Pulse is strictly forbidden.

Description: LTE698-960/1710-2690MHzSMA

Series: ICEBLADE

PART NUMBER: ICEBLADELS

MECHANICAL DRAWING

	A	B	C	D	E	F	G																										
MOB	Description	Reliability Test Spec according to WIHS75.33 (Reliability Test Working Instruction) Default test standard is Test Standard A if no definition	<table border="1" style="font-size: 8px;"> <tr> <th rowspan="2">ITEM</th> <th colspan="8">RoHS</th> </tr> <tr> <th>Cd</th> <th>Hg</th> <th>Pb</th> <th>PPM<</th> <th>PBB</th> <th>PBDE</th> <th colspan="2">OTHERS</th> </tr> <tr> <td>PPM<</td> <td>100</td> <td>1000</td> <td>1000</td> <td>1000</td> <td>1000</td> <td>1000</td> <td colspan="2"></td> </tr> </table>	ITEM	RoHS								Cd	Hg	Pb	PPM<	PBB	PBDE	OTHERS		PPM<	100	1000	1000	1000	1000	1000						
ITEM	RoHS																																
	Cd	Hg	Pb	PPM<	PBB	PBDE	OTHERS																										
PPM<	100	1000	1000	1000	1000	1000																											
A	A release																																

NOTES: UNLESS OTHERWISE SPECIFIED

- INTERPRET THIS SPECIFICATION PER PULSE PQ: 7.004.000 AND STANDARDS REFERENCED THEREIN.

ELECTRICAL SPECIFICATIONS:

- FREQ: MULTI BAND - 698-960/1710-2690 MHz
- VSWR: MULTI BAND - 2.5:1 MAX
- GAIN: 0 MIN-2 MAX dBi
- POWER WITHSTANDING: 3W

ENVIRONMENTAL:

- OPERATING TEMP: -40/+70 C°
- VIBRATION: 5-500 Hz FREQ, MIL STD 810 G section 514.6
- THERMAL SHOCK: 3 CYCLES MIL-STD 810G Method 503.4
- HUMIDITY: +30° @ 93% RH MIL-STD 810G Method 507.4
- DROP TEST: 1 METER, 1 DROP, 1 PER AXIS.

ITEM	QTY	PART NUMBER	DESCRIPTION
8	1	043-3905.001	ICEBLADE Plate
7	1	043-5091.001	WS080 Rubber White
6	2	0020.0015	PIVOT PIN
5	1	155-2250.001	ICEBladeLS SMA Cable Sub Assy
4	1	043-3757.001	ICE Blade Base
3	1	025-8121.001	ICE Blade LS FPC
2	1	043-3758.001	ICE Blade Radome Top
1	1	043-3755.001	ICE Blade Radome Swivel

PULSE (SUZHOU) WIRELESS PRODUCTS CO.,LTD.		99 HUALU RD, SUZHOU NEW DISTRICT 215009 P.R.CHINA WWW.PULSEELECTRONICS.COM/EN/MS	
PRODUCT(S)	ICEBLADELS	SCALE	1:1
ITEM	ICEBLADELS	DOCUMENT NUMBER	ICEBLADELS
		SHEET NUMBER	1/1
		GENERAL TOLERANCE	
		CUSTOMER NUMBER	
		DESIGN	Jessie Fei
		CHECKED	
		APPROVED	
		PART VERSION	V01
		DOCUMENT VERSION	10
		MOB	2016/7/19
		DATE	
		NAME	Jessie Fei

Issue:1747

In the effort to improve our products, we reserve the right to make changes judged to be necessary.

CONFIDENTIAL AND PROPRIETARY INFORMATION

This document contains confidential and proprietary information of Pulse Electronics, Inc. (Pulse) and is protected by copyright, trade secret and other state and federal laws. Its receipt or possession does not convey any rights to reproduce, disclose its contents, or to manufacture, use or sell anything it may describe. Reproduction, disclosure or use without specific written authorization of Pulse is strictly forbidden.

Description: LTE698-960/1710-2690MHzSMA

Series: ICEBLADE

PART NUMBER: ICEBLADELS

OTHER SPECIFICATIONS

VSWR

VSWR vs Frequency measured in free space
IceBladeLS measured in PSU

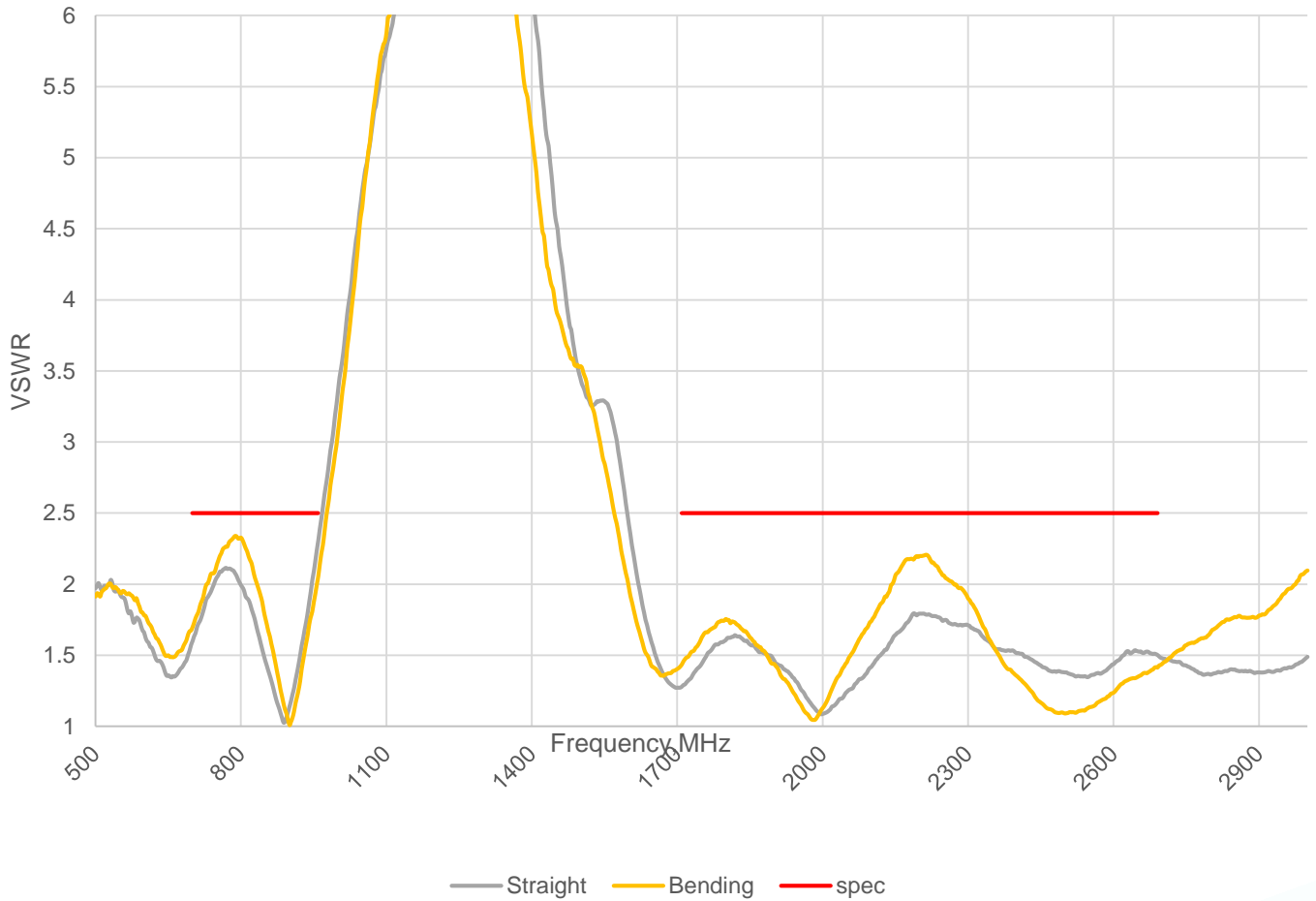

Issue:1747

In the effort to improve our products, we reserve the right to make changes judged to be necessary.

CONFIDENTIAL AND PROPRIETARY INFORMATION

This document contains confidential and proprietary information of Pulse Electronics, Inc. (Pulse) and is protected by copyright, trade secret and other state and federal laws. Its receipt or possession does not convey any rights to reproduce, disclose its contents, or to manufacture, use or sell anything it may describe. Reproduction, disclosure or use without specific written authorization of Pulse is strictly forbidden.

Description: LTE698-960/1710-2690MHzSMA

Series: ICEBLADE

PART NUMBER: ICEBLADELS

CHARTS

Efficiency

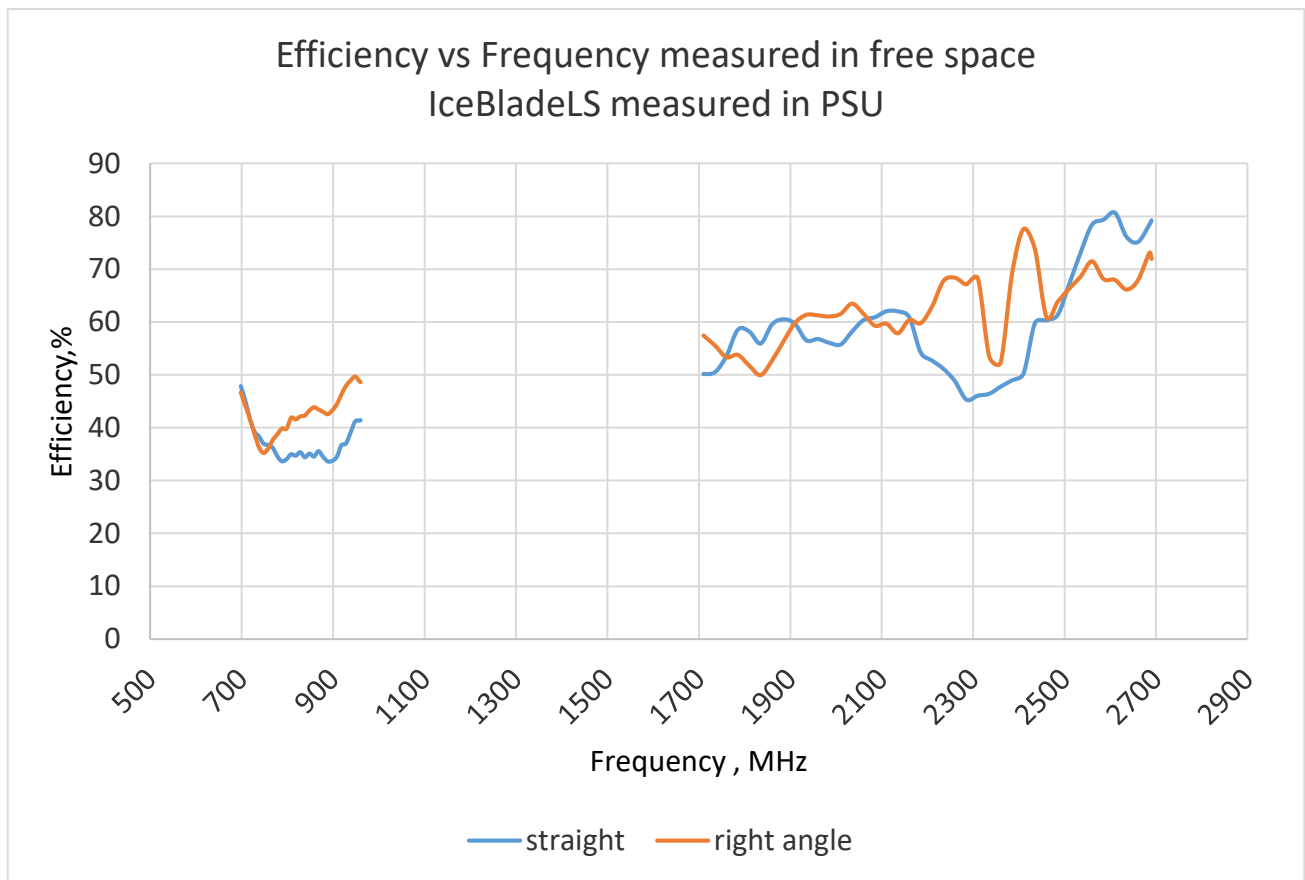

Issue:1747

In the effort to improve our products, we reserve the right to make changes judged to be necessary.

CONFIDENTIAL AND PROPRIETARY INFORMATION

This document contains confidential and proprietary information of Pulse Electronics, Inc. (Pulse) and is protected by copyright, trade secret and other state and federal laws. Its receipt or possession does not convey any rights to reproduce, disclose its contents, or to manufacture, use or sell anything it may describe. Reproduction, disclosure or use without specific written authorization of Pulse is strictly forbidden.

Description: LTE698-960/1710-2690MHzSMA

Series: ICEBLADE

PART NUMBER: ICEBLADELS

CHARTS

Peak Gain

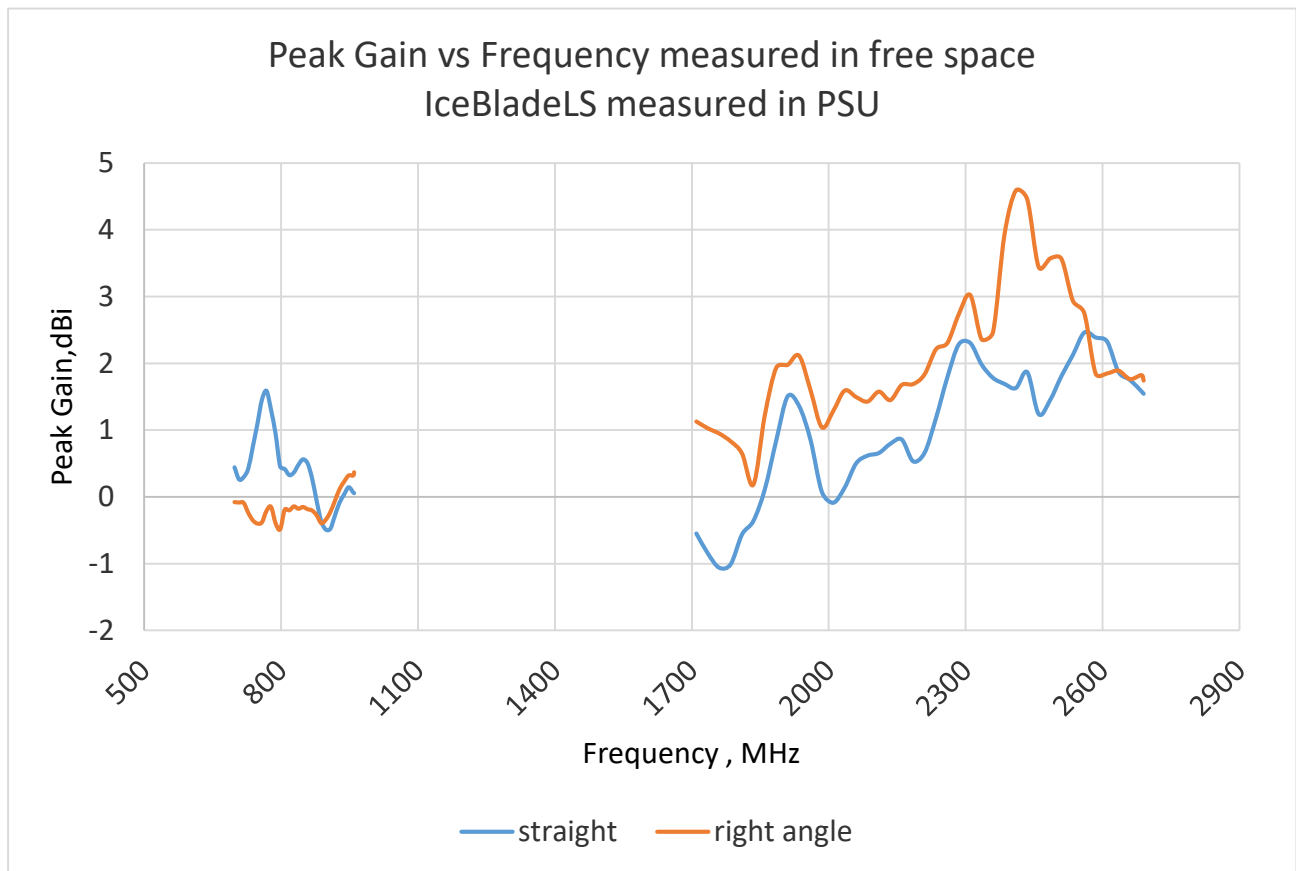

Issue:1747

In the effort to improve our products, we reserve the right to make changes judged to be necessary.

CONFIDENTIAL AND PROPRIETARY INFORMATION

This document contains confidential and proprietary information of Pulse Electronics, Inc. (Pulse) and is protected by copyright, trade secret and other state and federal laws. Its receipt or possession does not convey any rights to reproduce, disclose its contents, or to manufacture, use or sell anything it may describe. Reproduction, disclosure or use without specific written authorization of Pulse is strictly forbidden.

Description: LTE698-960/1710-2690MHzSMA

Series: ICEBLADE

PART NUMBER: ICEBLADELS

CHARTS

Gain Plots

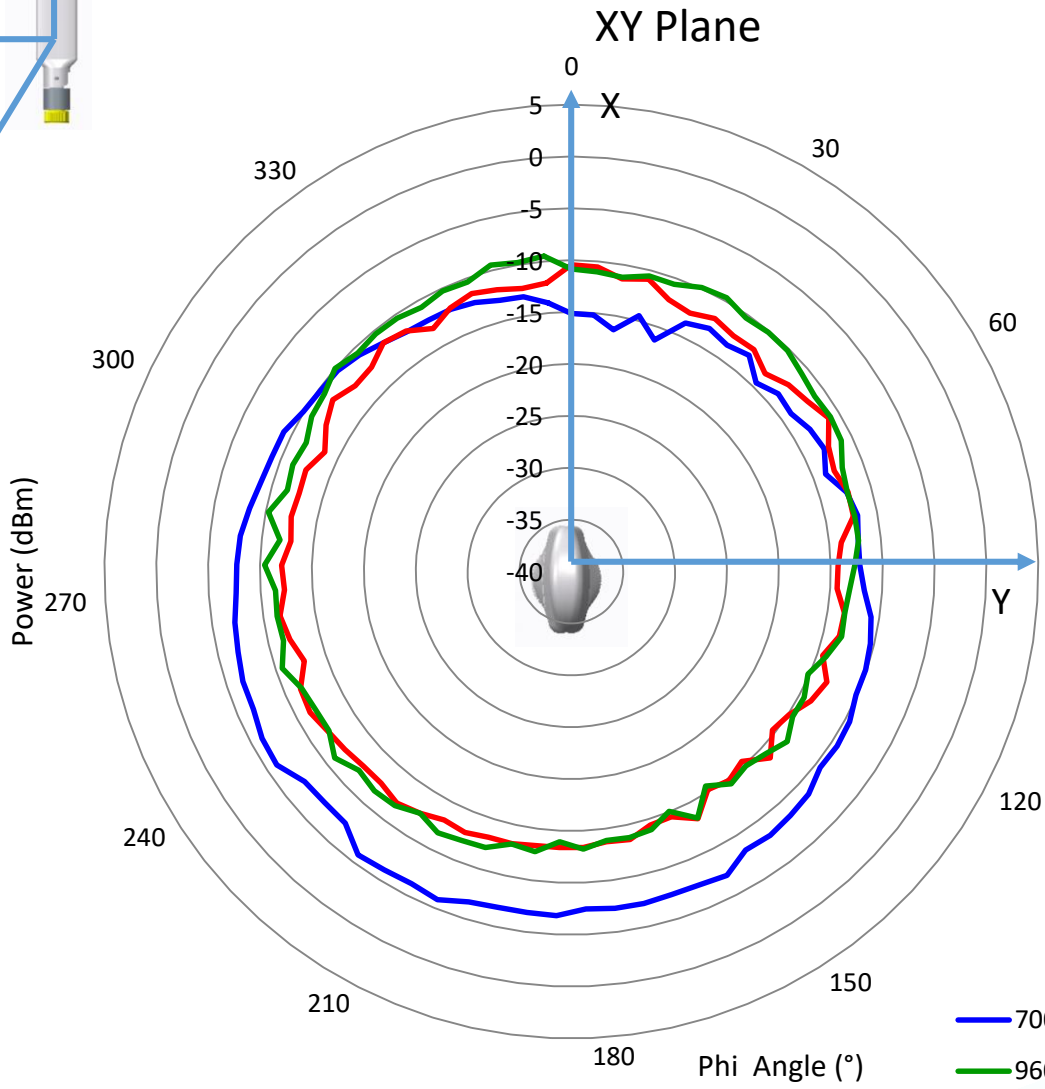
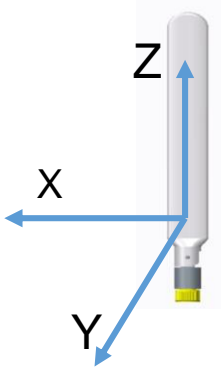

700MHz	Avg (dBi) = -10.12
	Peak (dBi) = -5.82
	Avg -3 (deg) = 15
	0
830MHz	Avg (dBi) = -12.75
	Peak (dBi) = -10.43
	Avg -3 (deg) = 28
	0
960MHz	Avg (dBi) = -11.88
	Peak (dBi) = -9.47
	Avg -3 (deg) = 24
	5

— 700MHz — 830MHz
— 960MHz

Issue:1747

In the effort to improve our products, we reserve the right to make changes judged to be necessary.

CONFIDENTIAL AND PROPRIETARY INFORMATION

This document contains confidential and proprietary information of Pulse Electronics, Inc. (Pulse) and is protected by copyright, trade secret and other state and federal laws. Its receipt or possession does not convey any rights to reproduce, disclose its contents, or to manufacture, use or sell anything it may describe. Reproduction, disclosure or use without specific written authorization of Pulse is strictly forbidden.

Description: LTE698-960/1710-2690MHzSMA

Series: ICEBLADE

PART NUMBER: ICEBLADELS

CHARTS

Gain Plots

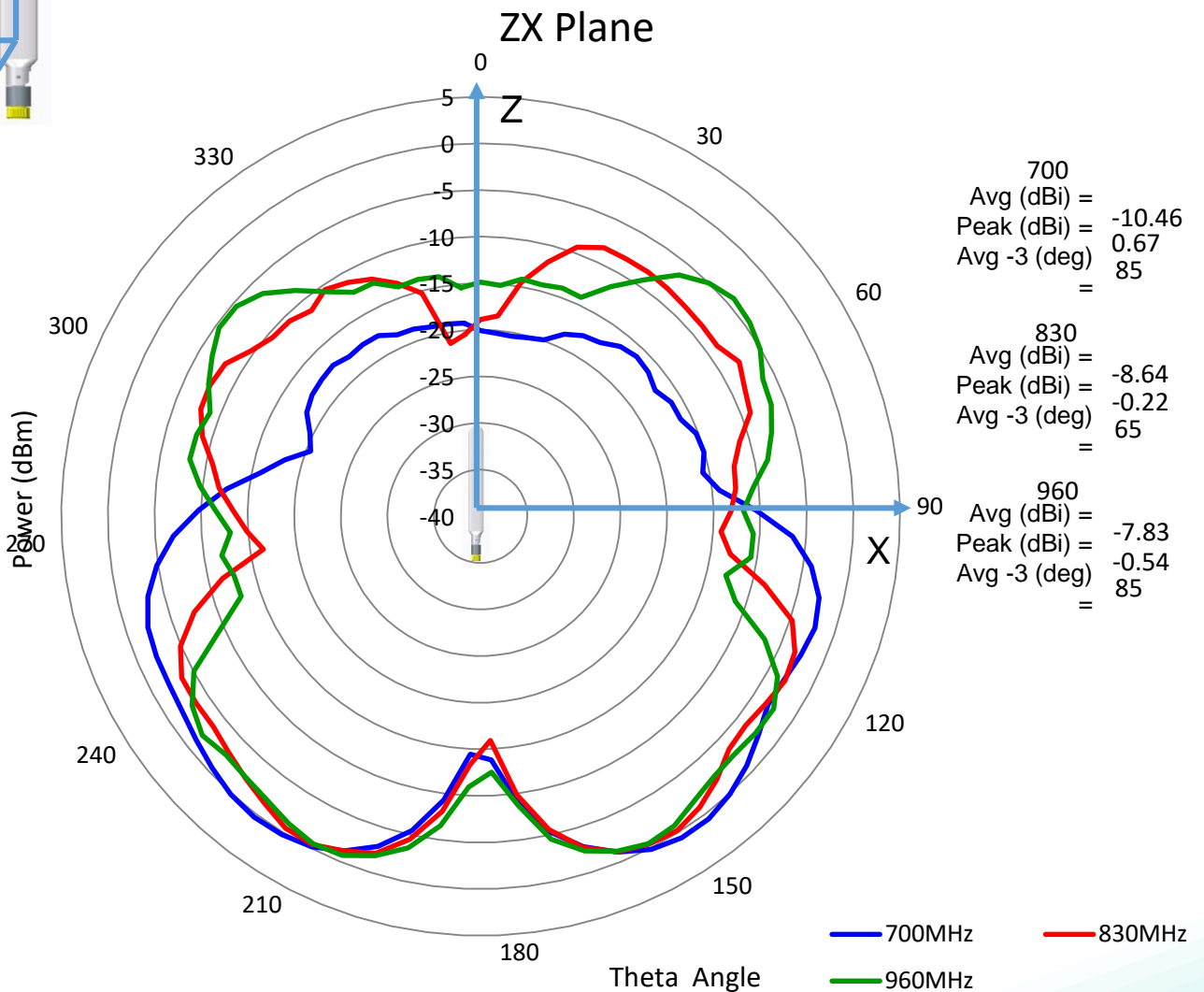
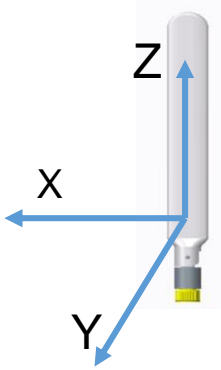

Issue:1747

In the effort to improve our products, we reserve the right to make changes judged to be necessary.

CONFIDENTIAL AND PROPRIETARY INFORMATION

This document contains confidential and proprietary information of Pulse Electronics, Inc. (Pulse) and is protected by copyright, trade secret and other state and federal laws. Its receipt or possession does not convey any rights to reproduce, disclose its contents, or to manufacture, use or sell anything it may describe. Reproduction, disclosure or use without specific written authorization of Pulse is strictly forbidden.

Description: LTE698-960/1710-2690MHzSMA

Series: ICEBLADE

PART NUMBER: ICEBLADELS

CHARTS

Gain Plots

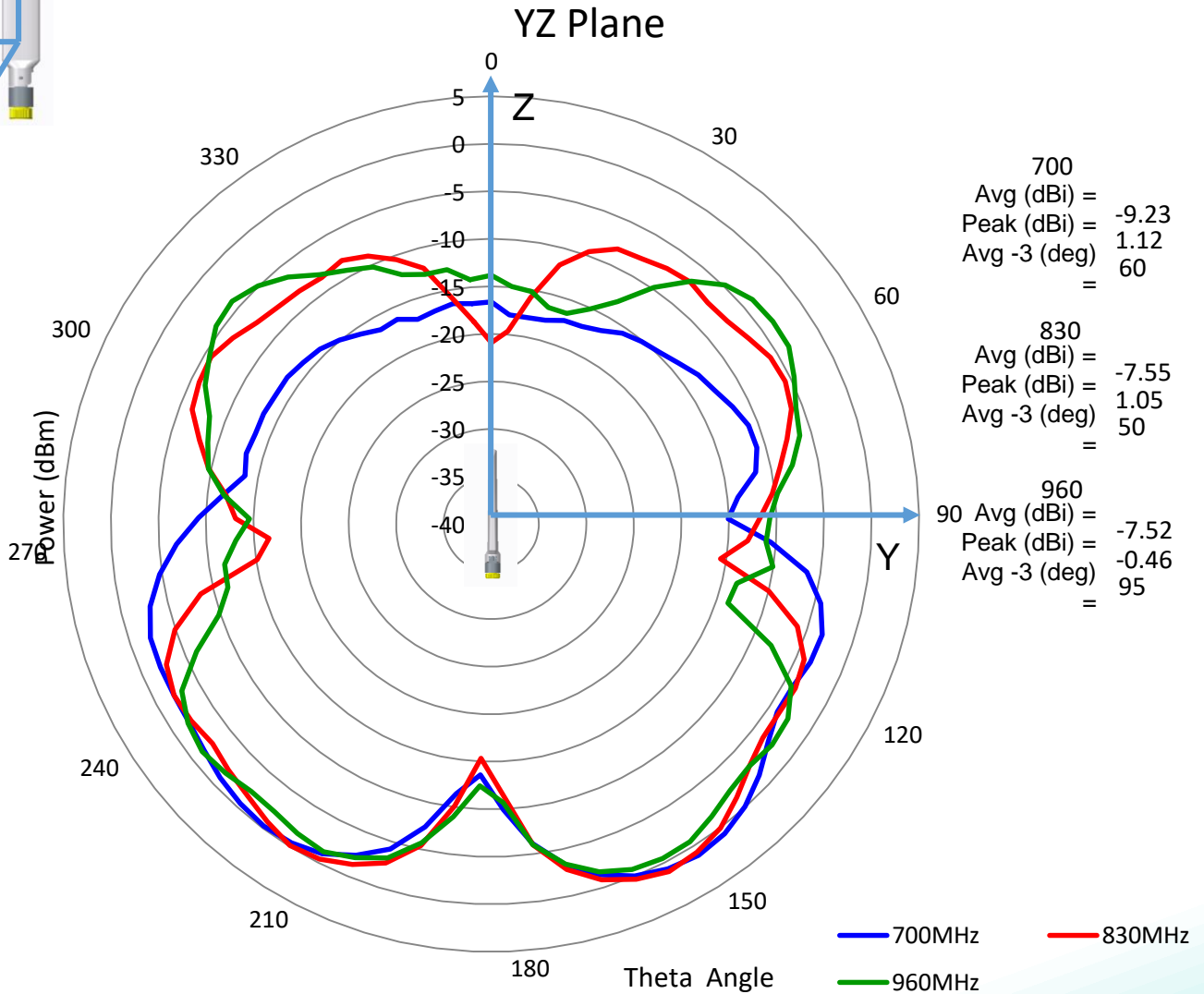
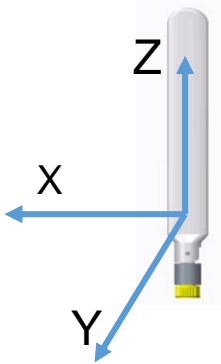

Issue:1747

In the effort to improve our products, we reserve the right to make changes judged to be necessary.

CONFIDENTIAL AND PROPRIETARY INFORMATION

This document contains confidential and proprietary information of Pulse Electronics, Inc. (Pulse) and is protected by copyright, trade secret and other state and federal laws. Its receipt or possession does not convey any rights to reproduce, disclose its contents, or to manufacture, use or sell anything it may describe. Reproduction, disclosure or use without specific written authorization of Pulse is strictly forbidden.

Description: LTE698-960/1710-2690MHzSMA

Series: ICEBLADE

PART NUMBER: ICEBLADELS

CHARTS

Gain Plots

XY Plane

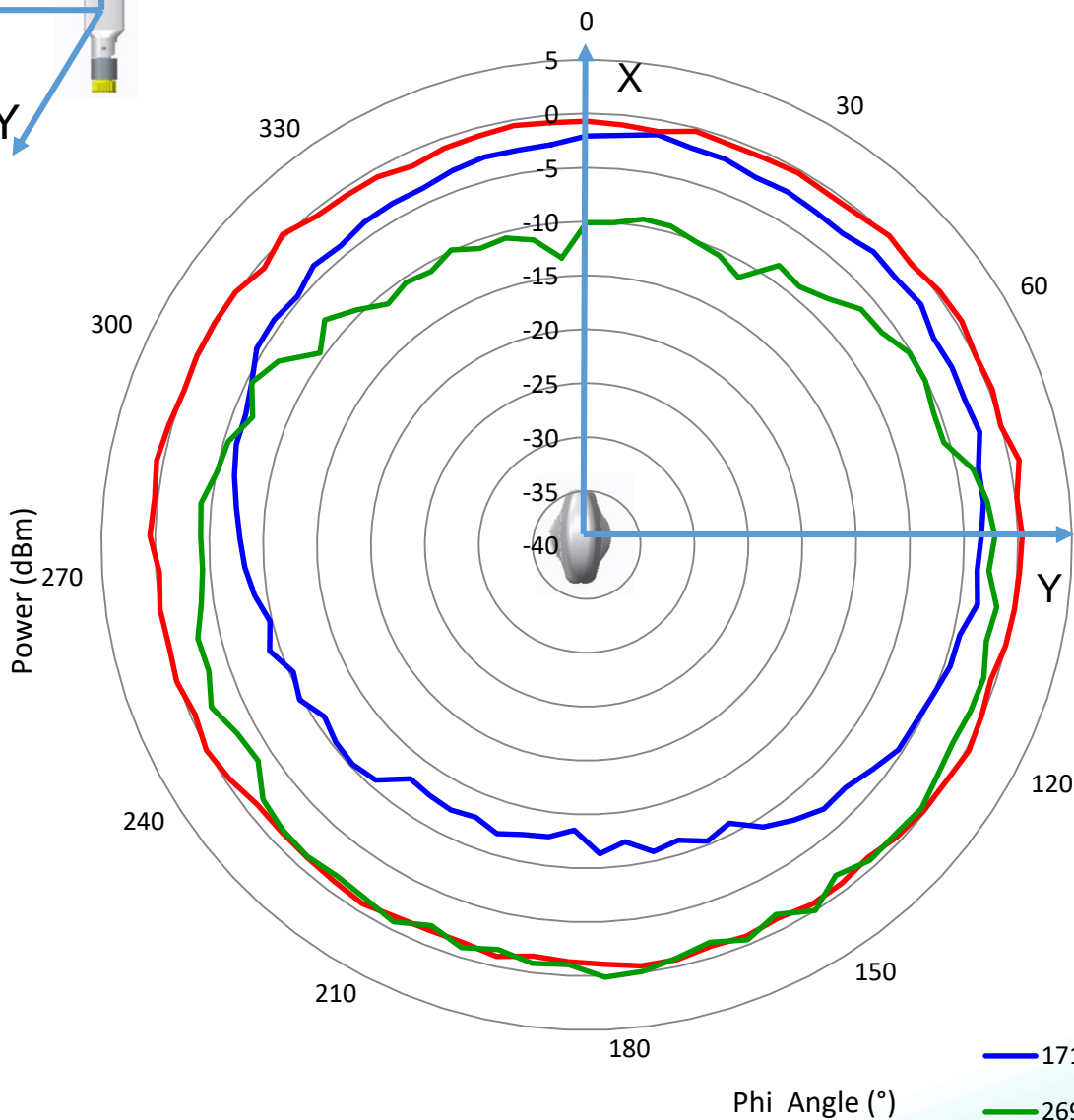
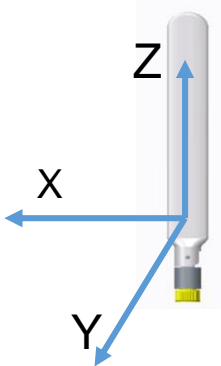

1710MHz	Avg (dBi) = -6.29
	Peak (dBi) = -1.40
	Avg -3 (deg) = 16
	0
2170MHz	Avg (dBi) = -0.41
	Peak (dBi) = 0.88
	Avg -3 (deg) = 36
	0
2690MHz	Avg (dBi) = -4.84
	Peak (dBi) = 0.14
	Avg -3 (deg) = 15
	5

— 1710MHz — 2170MHz
— 2690MHz

Issue:1747

In the effort to improve our products, we reserve the right to make changes judged to be necessary.

CONFIDENTIAL AND PROPRIETARY INFORMATION

This document contains confidential and proprietary information of Pulse Electronics, Inc. (Pulse) and is protected by copyright, trade secret and other state and federal laws. Its receipt or possession does not convey any rights to reproduce, disclose its contents, or to manufacture, use or sell anything it may describe. Reproduction, disclosure or use without specific written authorization of Pulse is strictly forbidden.

Description: LTE698-960/1710-2690MHzSMA

Series: ICEBLADE

PART NUMBER: ICEBLADELS

CHARTS

Gain Plots

ZX Plane

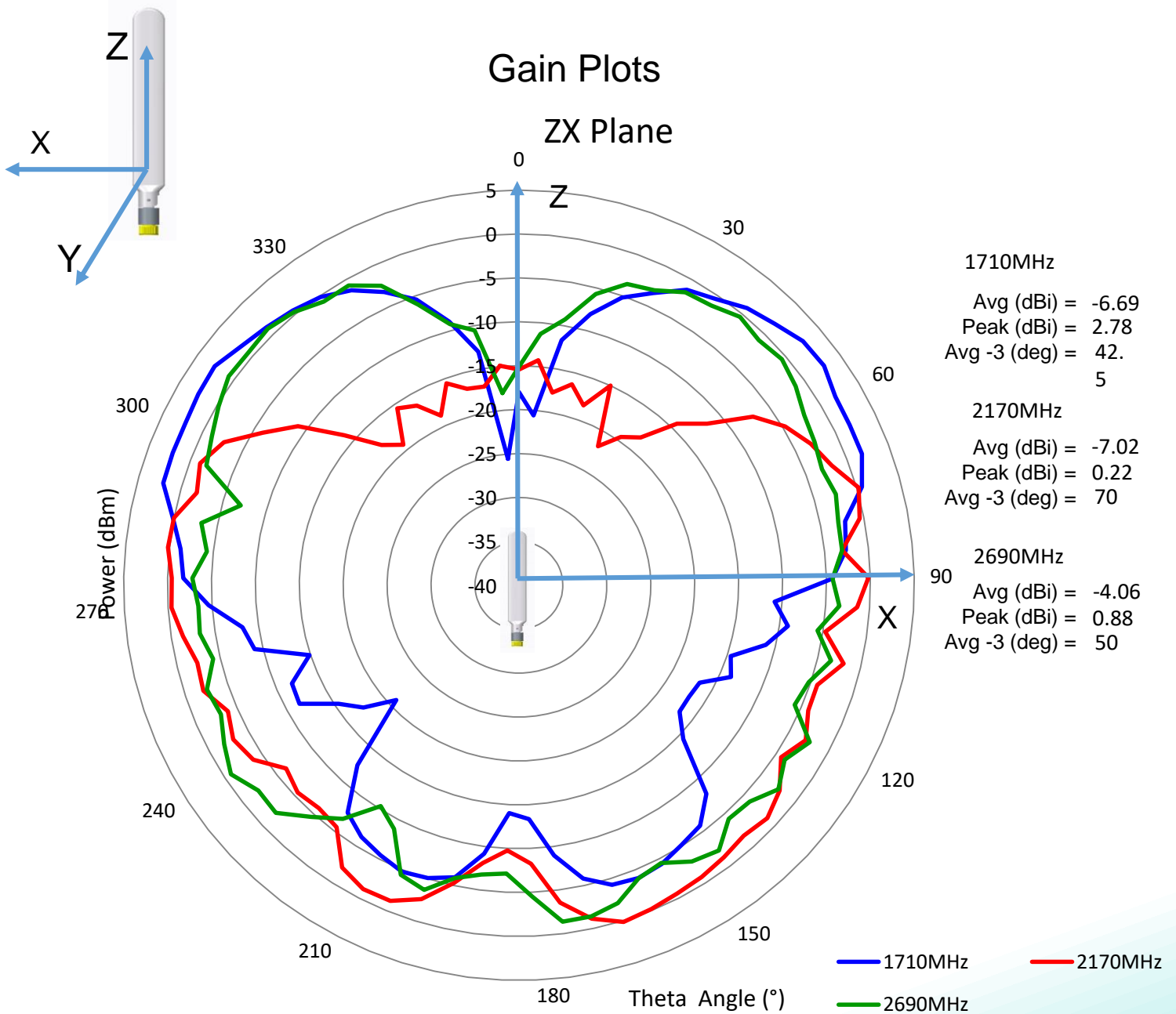

Issue:1747

In the effort to improve our products, we reserve the right to make changes judged to be necessary.

CONFIDENTIAL AND PROPRIETARY INFORMATION

This document contains confidential and proprietary information of Pulse Electronics, Inc. (Pulse) and is protected by copyright, trade secret and other state and federal laws. Its receipt or possession does not convey any rights to reproduce, disclose its contents, or to manufacture, use or sell anything it may describe. Reproduction, disclosure or use without specific written authorization of Pulse is strictly forbidden.

Description: LTE698-960/1710-2690MHzSMA

Series: ICEBLADE

PART NUMBER: ICEBLADELS

CHARTS

Gain Plots

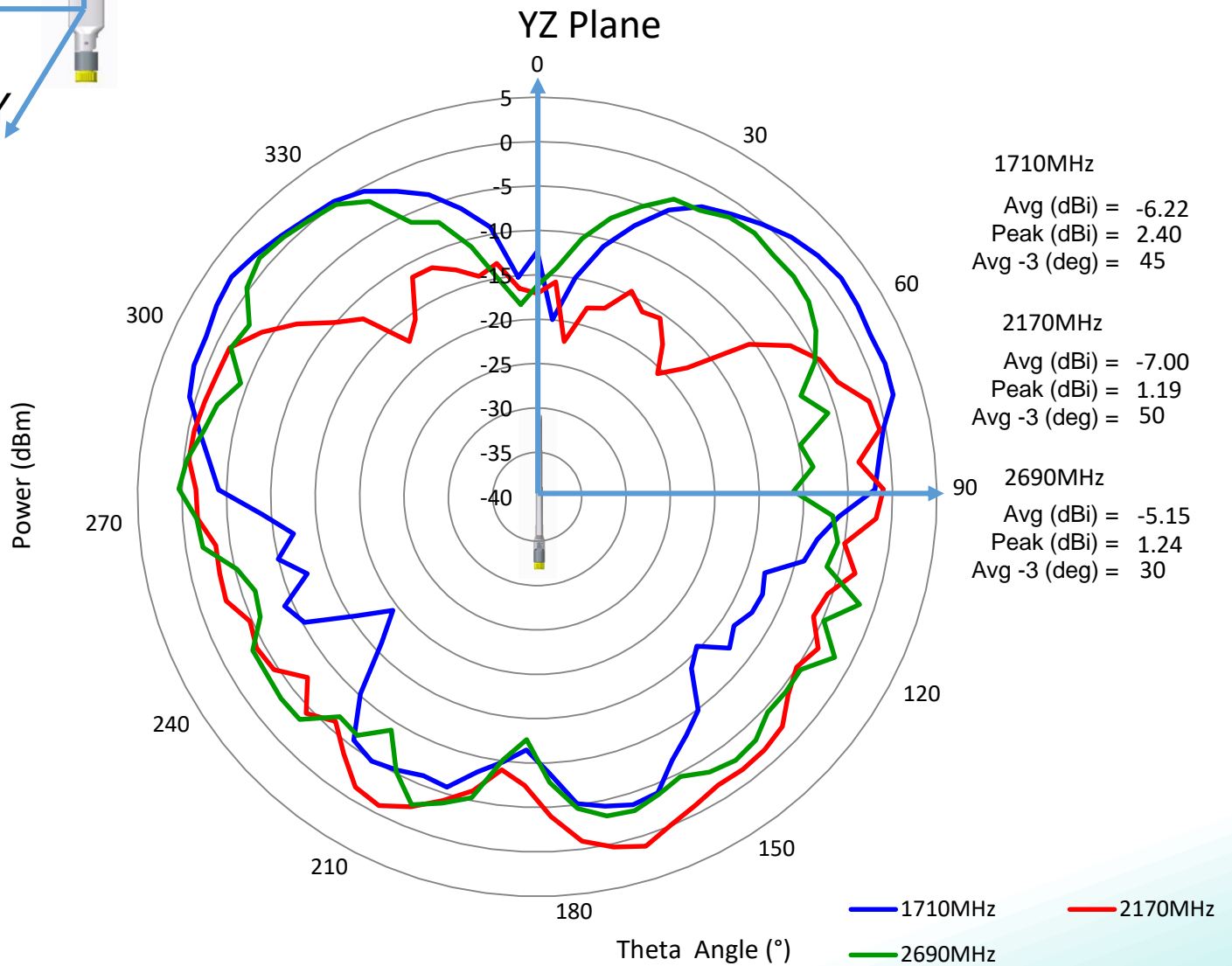
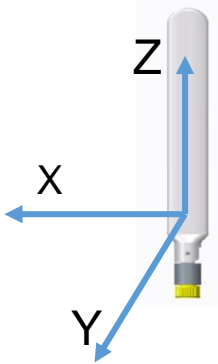

Issue:1747

In the effort to improve our products, we reserve the right to make changes judged to be necessary.

CONFIDENTIAL AND PROPRIETARY INFORMATION

This document contains confidential and proprietary information of Pulse Electronics, Inc. (Pulse) and is protected by copyright, trade secret and other state and federal laws. Its receipt or possession does not convey any rights to reproduce, disclose its contents, or to manufacture, use or sell anything it may describe. Reproduction, disclosure or use without specific written authorization of Pulse is strictly forbidden.

Description: LTE698-960/1710-2690MHzSMA

Series: ICEBLADE

PART NUMBER: ICEBLADELS

PACKAGING

Pack each antenna into PE bag, 100 antenna in one box

单击下面可查看定价，库存，交付和生命周期等信息

[>>Pulse\(普思\)](#)