

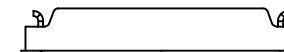

NOTES:

1. ROHS COMPLIANT
2. PLASTIC: THERMOSET PLASTIC MATERIAL WITH FLAMMABILITY RATING UL 94V-0 OR BETTER.
3. STORAGE TEMPERATURE: -20°C TO +125°C
4. COMPLIANCE TO J-STD:
 - A. J-STD-002: SOLDERABILITY AT 245°C REFLOW PROFILE
 - B. J-STD-020: MOISTURE SENSITIVE LEVEL 1
 - C. J-STD-075: R7, 245°C MAXIMUM THROUGH REFLOW SOLDER
5. TO ORDER TAPE & REEL PACKAGING ADD A "T" SUFFIX TO THE PART NUMBER(i.e H7800NL BECOMES H7800NLT).

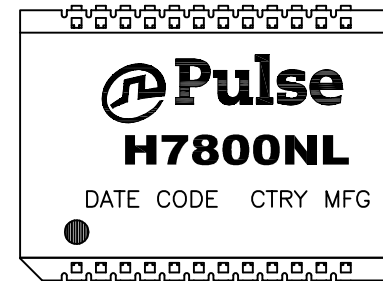

FINAL OUTLINE

© Copyright, 2018. Pulse Electronics Corp. All rights reserved. Pulse confidential & proprietary. (03/19/18)

PRODUCT DESCRIPTION	TLA DRAWING	PS DRAWING	SHEET	PART NO.	DATASHEET REV.
MDL,SIN,10GD,1:1,SM,TU	H7800NL-11	PS-2328.001-B	1 OF 3	H7800NL	A

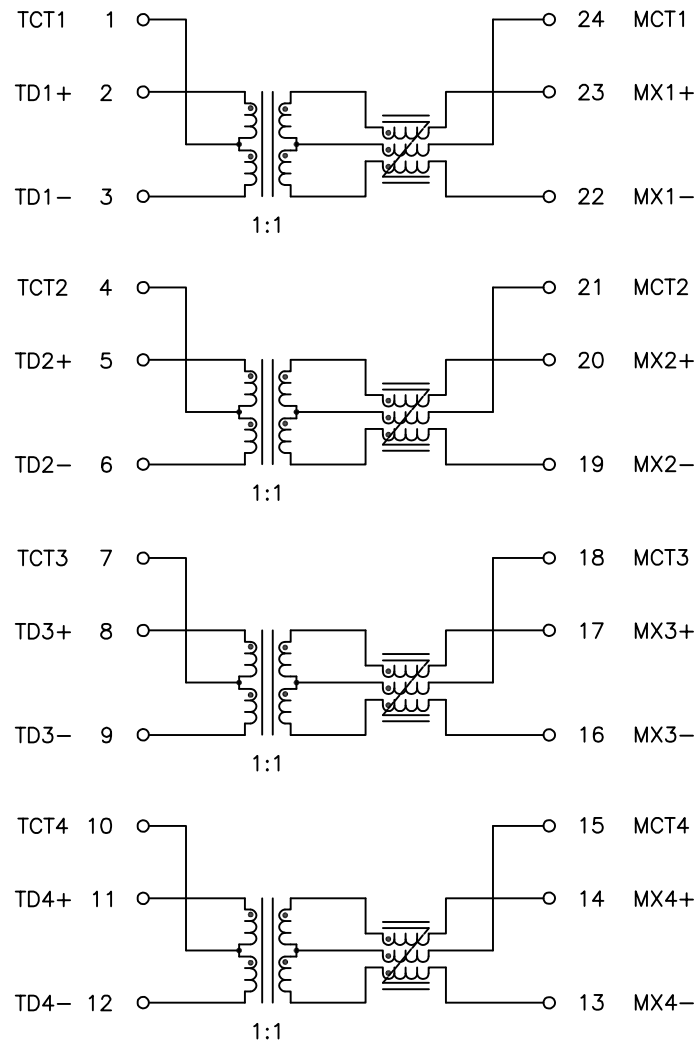

SCHEMATIC

ELECTRICAL CHARACTERISTICS AT +25°C UNLESS OTHER SPECIFIED
(FOR REFERENCE ONLY. USED FOR CUSTOMER INFORMATION.)

PARAMETER	SPECIFICATIONS		
OPERATING TEMP	0°C TO +70°C		
URNS RATIO	1 : 1 ±2%		
POLARITY	PER SCHEMATIC		
INSERTION LOSS	100 KHz	1-500 MHz	
	-3.0 dB MAX	-1.0 dB MAX (-.6 dB TYP)	
RETURN LOSS (Z OUT = 100 OHM ± 1%)	1-40 MHz	40 MHz-500 MHz	
	-18 dB MIN	-17 + 10*LOG ₁₀ (f/40) dB MIN	
INDUCTANCE (OCL)	200 uH MIN @ 100 kHz, 100 mV		
CROSSTALK, ADJACENT CHANNELS	1-100 MHz	100-500 MHz	
	-40 dB MIN	-30 dB MIN	
COMMON MODE REJECTION RATIO	1-100 MHz	100-300 MHz	300-500 MHz
	-35 dB MIN	-30 dB MIN	-25 dB MIN
	COMMON TO DIFFERENTIAL MODE REJECTION (CDMR)		250-500 MHz
	1-250 MHz		
	-30 dB MIN	-22 dB MIN	
INPUT - OUTPUT ISOLATION	1500 VRMS MIN @ 60 SECONDS		

NOTE: f IS FREQUENCY IN MHZ.

© Copyright, 2018. Pulse Electronics Corp. All rights reserved. Pulse confidential & proprietary. (03/19/18)

PRODUCT DESCRIPTION	TLA DRAWING	PS DRAWING	SHEET	PART NO.	DATASHEET REV.
MDL,SIN,10GD,1:1,SM,TU	H7800NL-11	PS-2328.001-B	2 OF 3	H7800NL	A

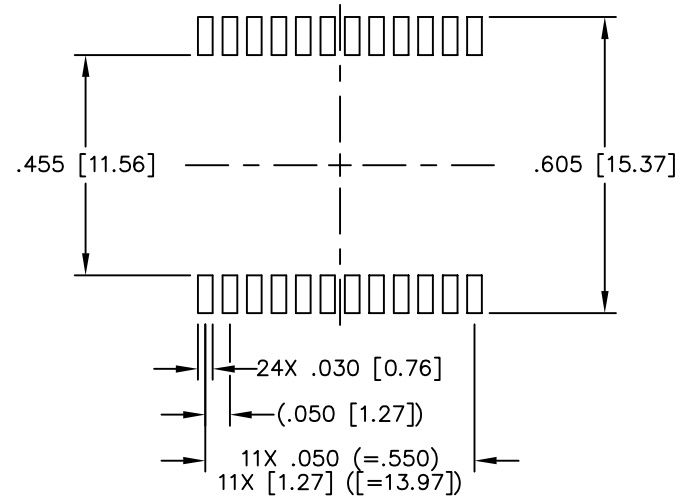
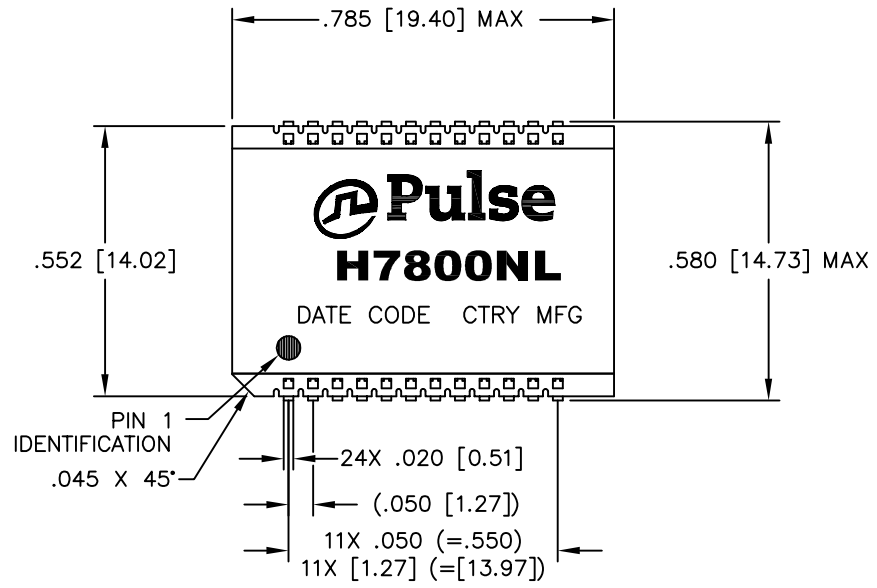

SUGGESTED LAND PATTERN

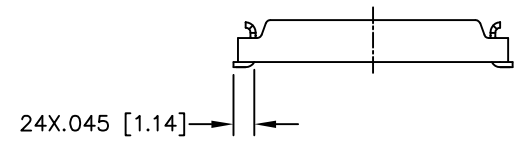
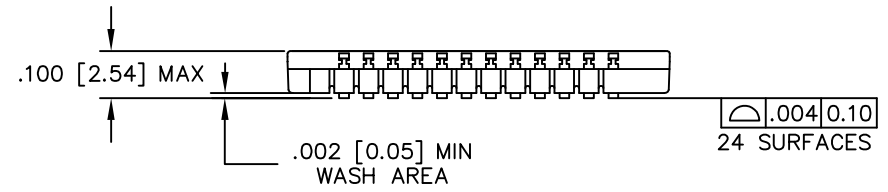

DIMENSIONS ARE IN INCHES [MILLIMETERS] WITH THE FOLLOWING TOLERANCES: [MILLIMETERS] ARE FOR REFERENCE ONLY.
.XX= ±.01 [±0.25]
.XXX= ±.005 [±0.13]

© Copyright, 2018. Pulse Electronics Corp. All rights reserved. Pulse confidential & proprietary. (03/19/18)

PRODUCT DESCRIPTION	TLA DRAWING	PS DRAWING	SHEET	PART NO.	DATASHEET REV.
MDL,SIN,10GD,1:1,SM,TU	H7800NL-11	PS-2328.001-B	3 OF 3	H7800NL	A

单击下面可查看定价，库存，交付和生命周期等信息

[>>Pulse\(普思\)](#)